



御天金甲  
SKY DOMINATOR  
P095

# 拼装说明书



**AGES 14+**

本产品为金属制品，14岁以下需由成人陪同完成！

© WIST PLASTIC & METAL TECHNOLOGY LIMITED. ALL RIGHTS RESERVED.

电子版下载地址：<http://www.piececool.com/cpshuoming/P095.pdf>

Piececool  
拼酷

## 前言

感谢您购买拼酷御天金甲金属拼装模玩，在开始拼装此款模型前，请先阅读本说明书，请按照说明书拼装步骤要求拼装此款模型。

请将金属片板件及未拼装完的金属零件放置于小孩不能触及的地方，避免发生意外，此款模型适合14岁以上年龄层，14岁以下需由成人陪同完成。

在拼装前请先阅读拼前须知，准备拼装工具及知晓拼装方法，方便拼装过程的顺利进行。

御天金甲模型在拼装过程中能训练手脑协调能力，建立空间想象力，培养耐心与信心。由于御天金甲模型零件数较多，拼装时间较长，请玩家保持信念。

拼酷秉承“让每个玩家都能享受金属拼装带来的乐趣与成就”的品牌使命，一如既往的保持对金属模玩创作的热情，研发更多为拼酷粉丝喜爱的作品！再次感谢您购买拼酷御天金甲金属模玩，愿拼酷模玩能与您相伴并给您带来快乐。

Piececool  
拼酷

# 目录

<b>1 拼前需知</b>	
(1) 准备工具.....	4
(2) 取下零件.....	4
(3) 认清零件.....	4
(4) 折叠零件.....	5
(5) 固定零件.....	5
(6) 注意事项.....	5
<b>2 拼装步骤</b>	
Step.1 头部拼装.....	9
Step.2 胸部拼装.....	13
Step.3 肩部拼装.....	21
Step.4 左臂拼装.....	27
Step.5 右臂拼装.....	31
Step.6 左腿拼装.....	35
Step.7 右腿拼装.....	45
Step.8 腰部拼装.....	51
Step.9 前面装备拼装.....	55
Step.10 后面装备拼装.....	59
Step.11 武器装备拼装.....	63

## 1.拼前需知

### (1) 准备工具



水口钳工具

金属拼装模型必备工具，  
修剪金属片板件上的零件水口位。



尖嘴钳工具

金属拼装模型必备工具，  
折弯金属零件上的折叠线和扣点。

### (2) 取下零件



使用水口钳剪断金属零件上的水口，  
将需要的金属零件从金属片板件取下。

### (3) 认清零件

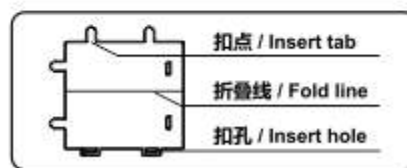

认清金属零件上  
的扣点、折叠线、扣孔的样子。

### (4) 折叠零件

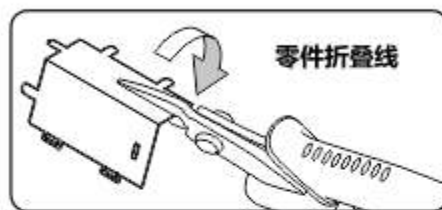

使用尖嘴钳，参照拼装说明书  
将金属零件折成形状。

### (5) 固定零件



扣点插入扣孔，平折  
90°，固定零件。



扣点插入扣孔，旋转  
90°，固定零件。

### (6) 注意事项

①剪金属零件时请剪零件“水口位”，请勿将“扣点”当成“水口位”剪下，每次剪零件时请仅剪当前步骤的零件，切勿一次性将所有零件全部剪下，避免丢失；

②当遇到折叠线的零件，请注意金属片正反面及拼折方向，请按照说明书说明的方向，轻剪慢折，最好一次折叠完成，请勿反复折叠，避免零件损坏。



无需使用胶水，建议使用拼酷正品拼装工具（水口钳、尖嘴钳），拼装时更省心、省力，拼装后作品更精细、美观！

Don't need to use glue, we suggest to use the assembly tool with Piececool brand (Cutting Pliers, Bending Pliers). Saving the assembly time, assembling the model easily, making the model more exquisite and beautiful!

**Step.2**  
胸部拼装  
共18个步骤  
第13-20页

**Step.1**  
头部拼装  
共7个步骤；第9-12页

**Step.3**  
肩部拼装  
共11个步骤  
第21-26页

**Step.5**  
右臂拼装  
共4个步骤  
第31-34页

**Step.4**  
左臂拼装  
共6个步骤  
第27-30页

**Step.11**  
武器装备拼装  
共16个步骤  
第63-70页

**Step.9**  
前面装备拼装  
共8个步骤  
第55-58页

**Step.7**  
右腿拼装  
共8个步骤  
第45-50页

**Step.6**  
左腿拼装  
共27个步骤  
第35-44页



**Step.10**  
后面装备拼装  
共8个步骤  
第59-62页

**Step.3**  
肩部拼装  
共11个步骤  
第21-26页

**Step.8**  
腰部拼装  
共5个步骤  
第51-54页



Piececool  
拼酷

## Step.1 头部拼装

- 第01小步：零件编号E1,F1,G1,H1,I1,J1,A2,B2,C2,K2
- 第02小步：零件编号F3,I3,J3,A4,B4,C4,A5,B5,C5
- 第03小步：零件编号F6,B7,C8
- 第04小步：零件编号H9,B10,C11
- 第05小步：零件编号D12,B13,I14,G15
- 第06小步：零件编号B16,A17,I18
- 第07小步：零件编号I19,H20,L20,G21,J22

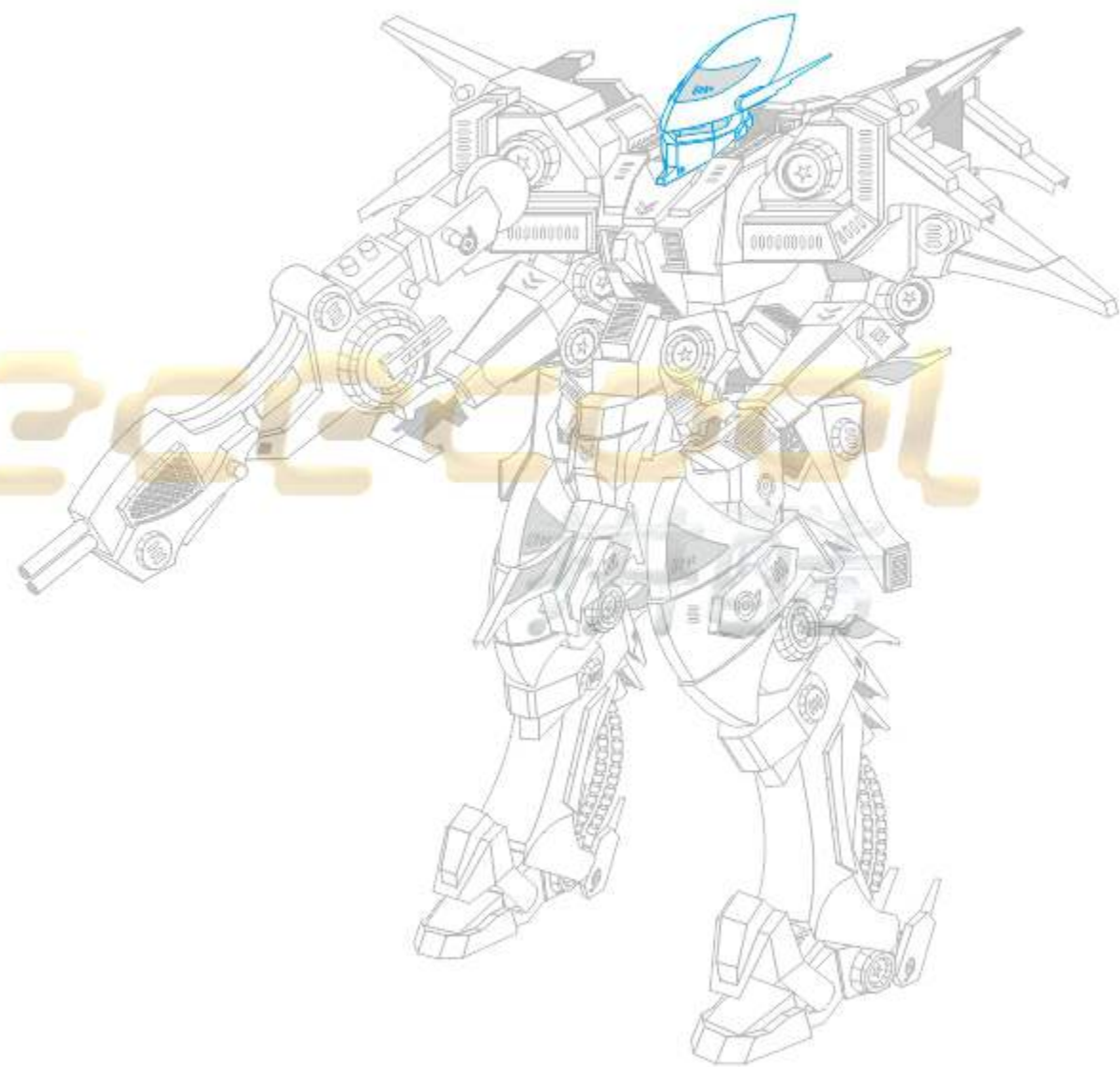

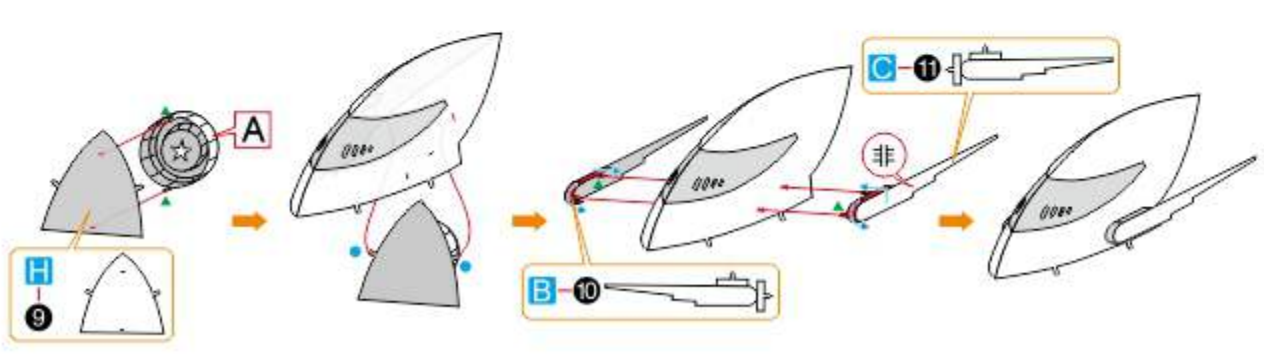
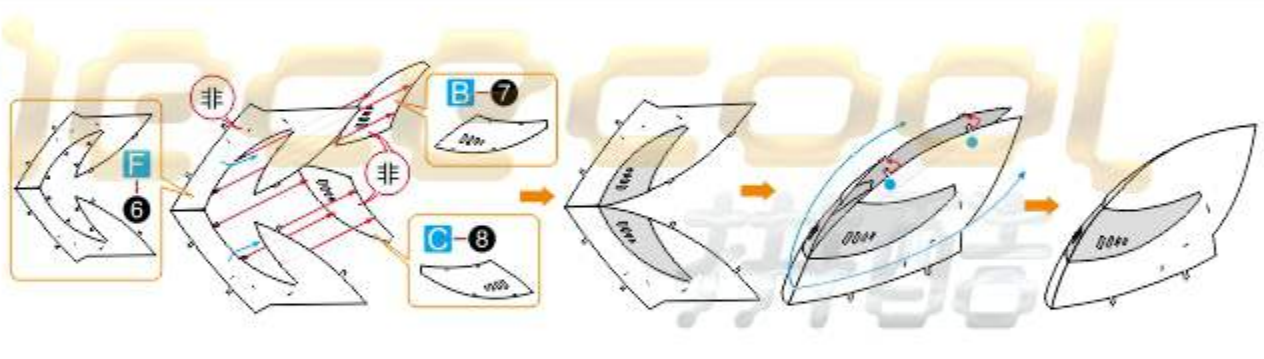
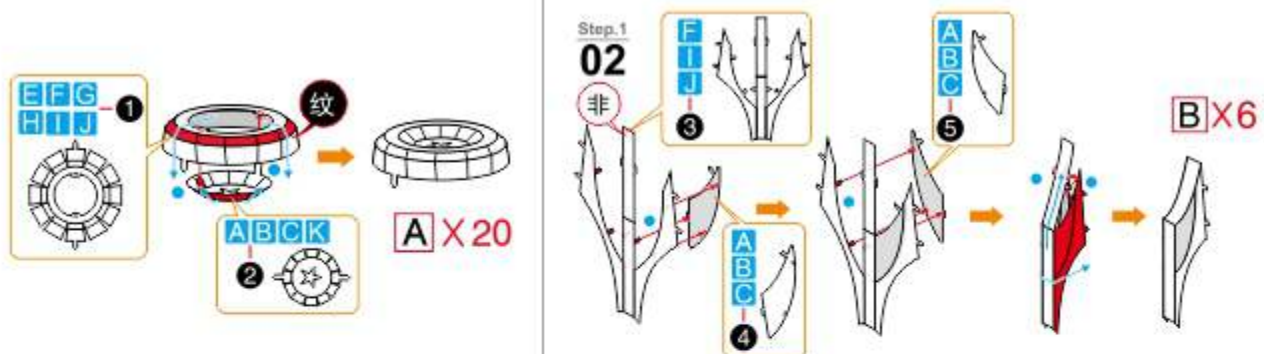
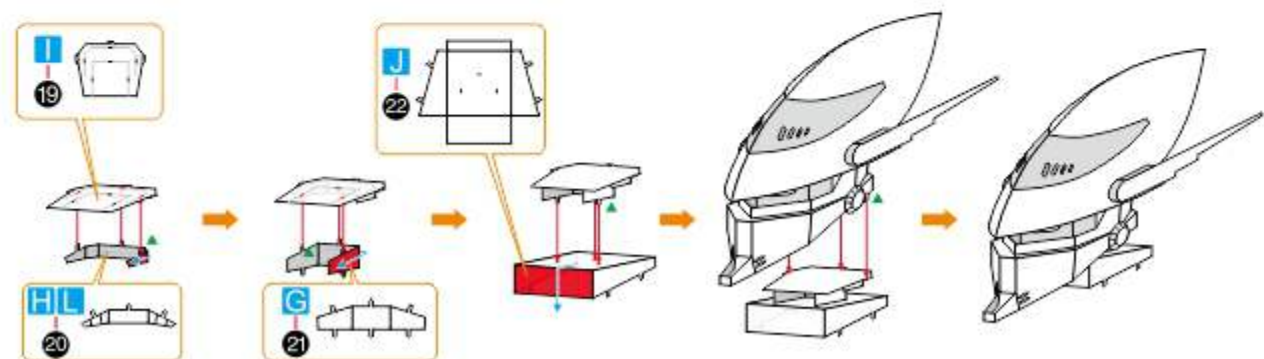
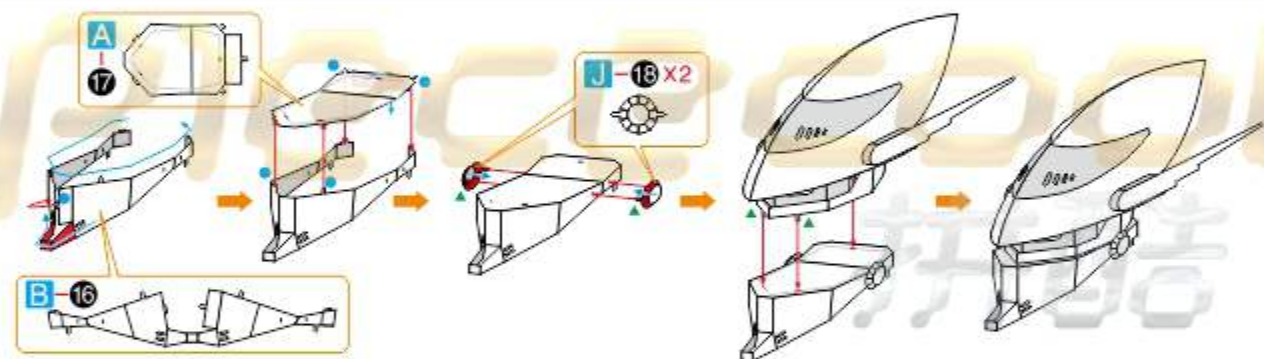
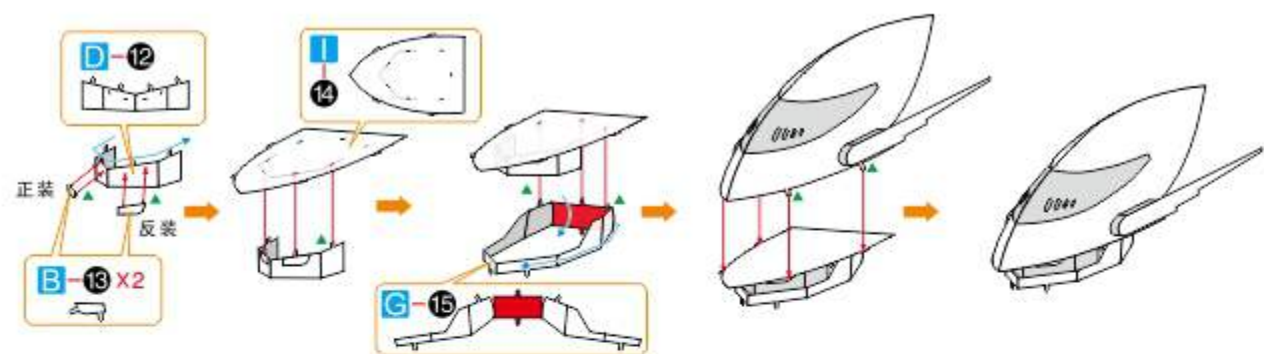

Piececool  
拼酷

## Step.2 胸部拼装

- 第01小步：零件编号A23,B23,E24,J24,A25,B25
- 第02小步：零件编号H26,E27,J27
- 第03小步：零件编号C28
- 第04小步：零件编号B29,E30
- 第05小步：零件编号B31,G30,J30
- 第06小步：零件编号B32,J33
- 第07小步：零件编号C34,C35,I36,H37,J38
- 第08小步：零件编号G39,A40
- 第10小步：零件编号H41,E42,H43,J43,C44
- 第11小步：零件编号E45,F45,H45,I45,J45,L45,A46,K46
- 第12小步：零件编号E47,F47,L47
- 第13小步：零件编号F48
- 第15小步：零件编号C49,G50
- 第16小步：零件编号I51,B46
- 第18小步：零件编号A52

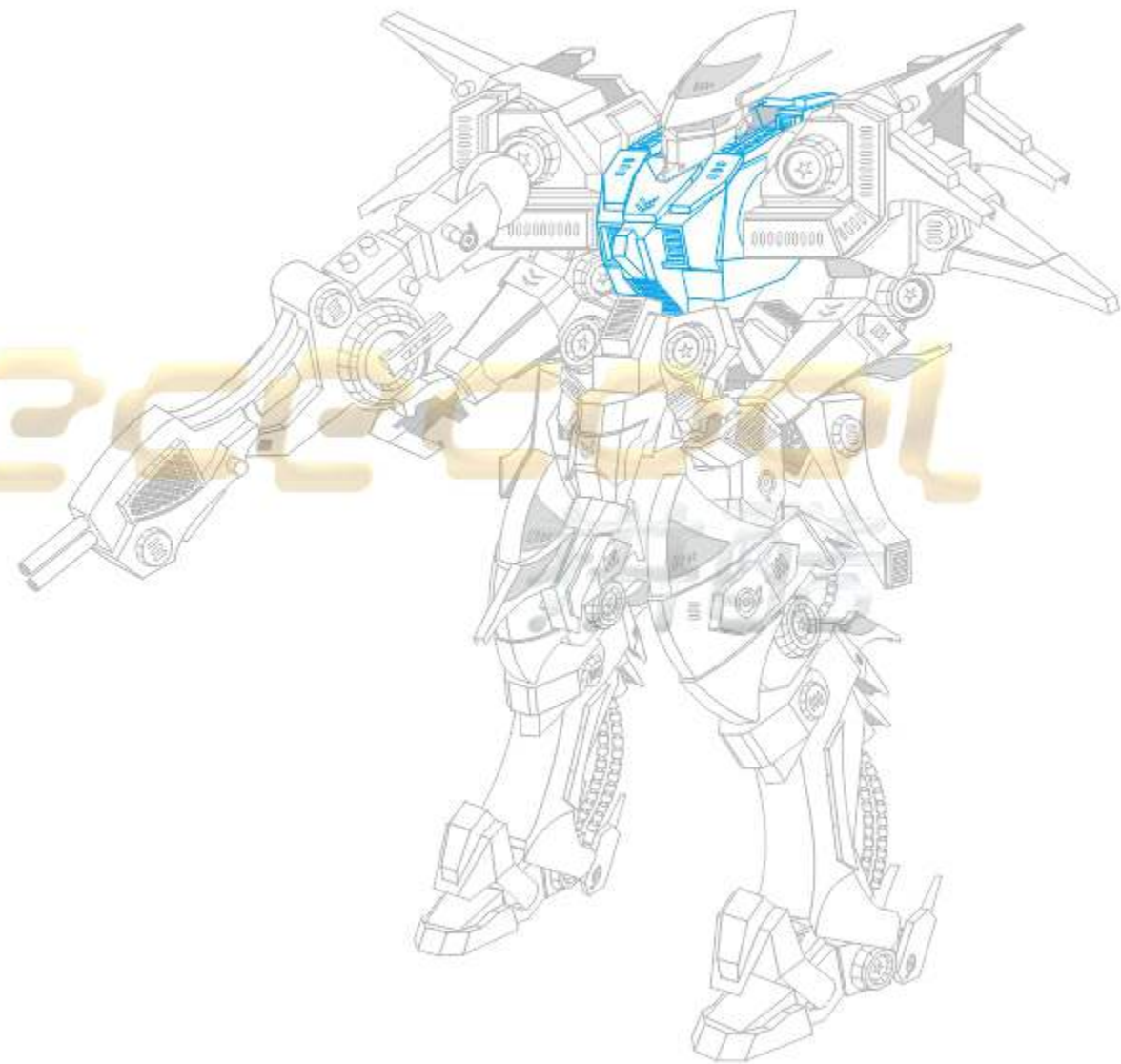
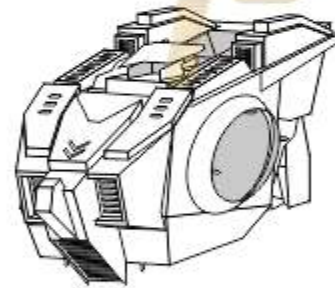

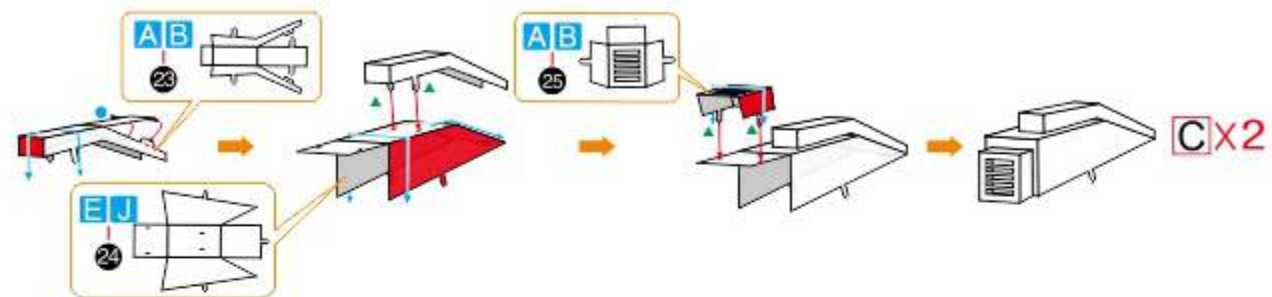
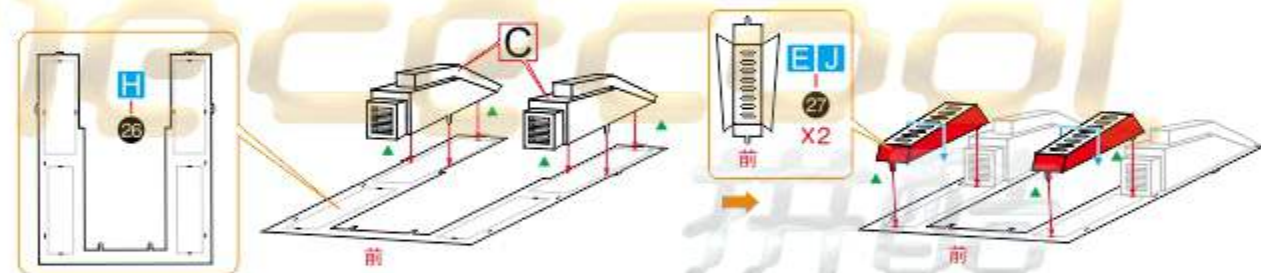
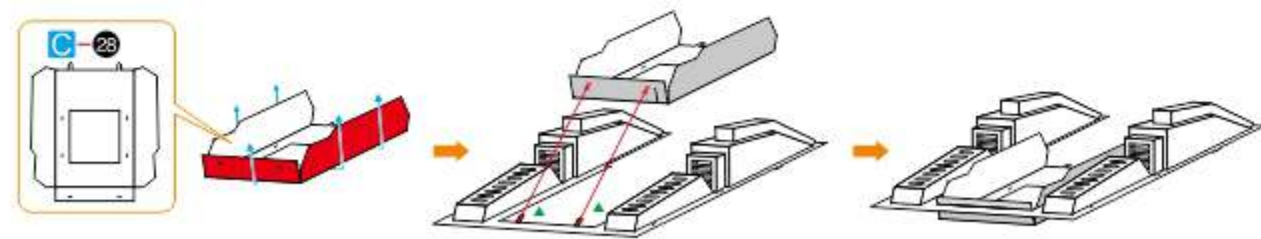
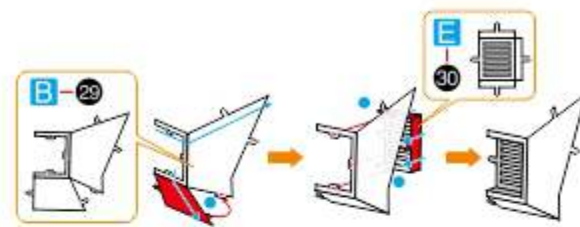
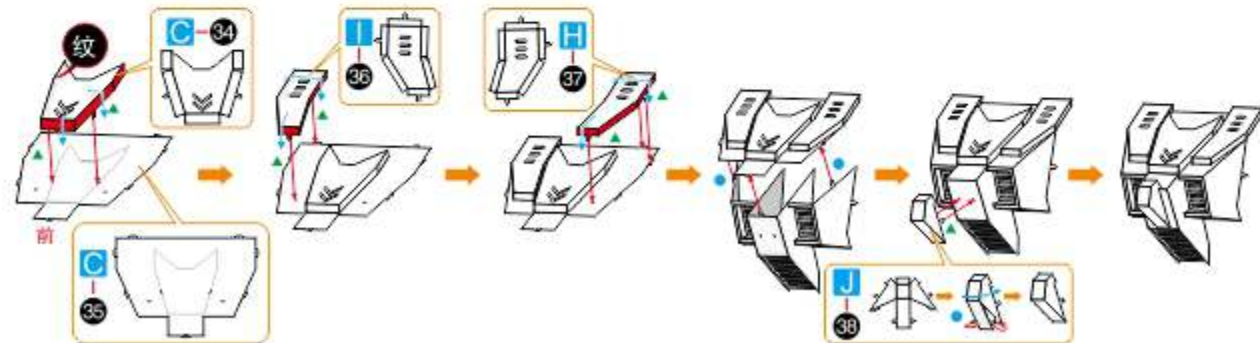

Step.2  
01Step.2  
02Step.2  
03Step.2  
04Step.2  
05Step.2  
06Step.2  
07

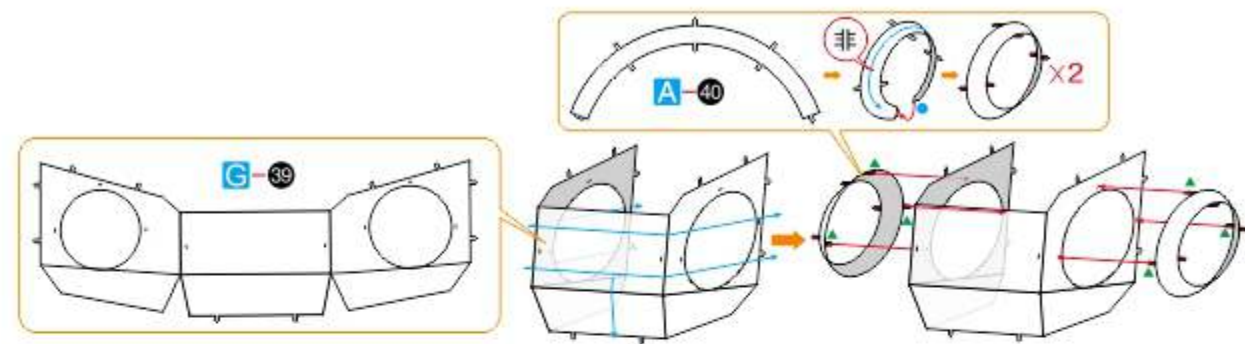
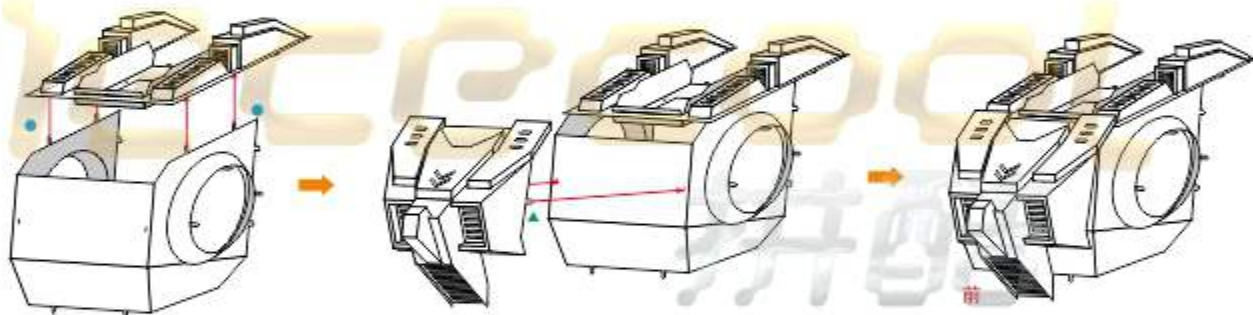
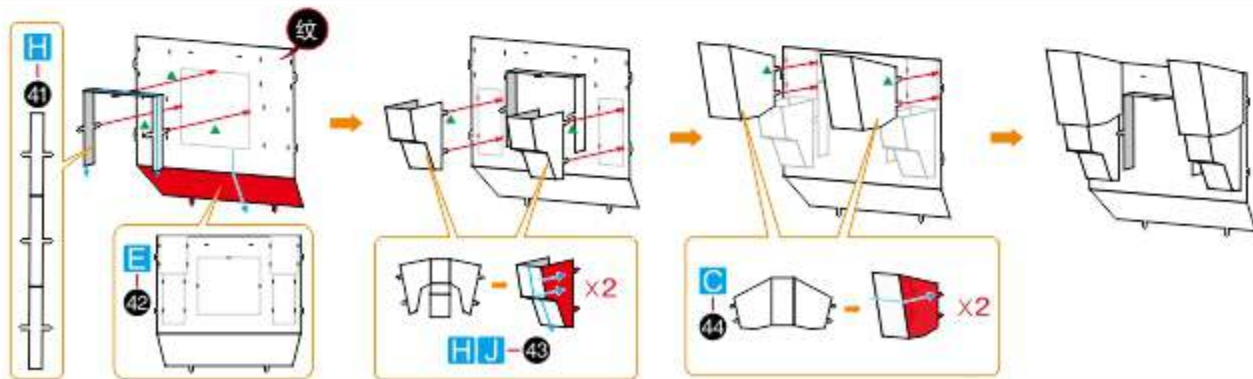
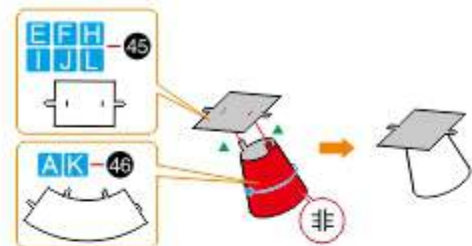
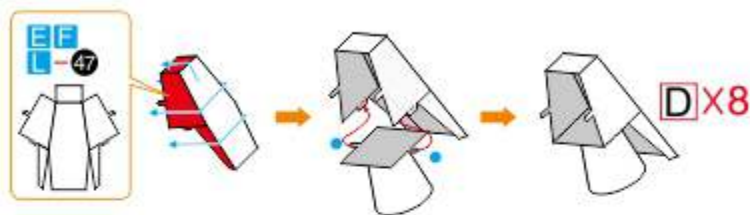
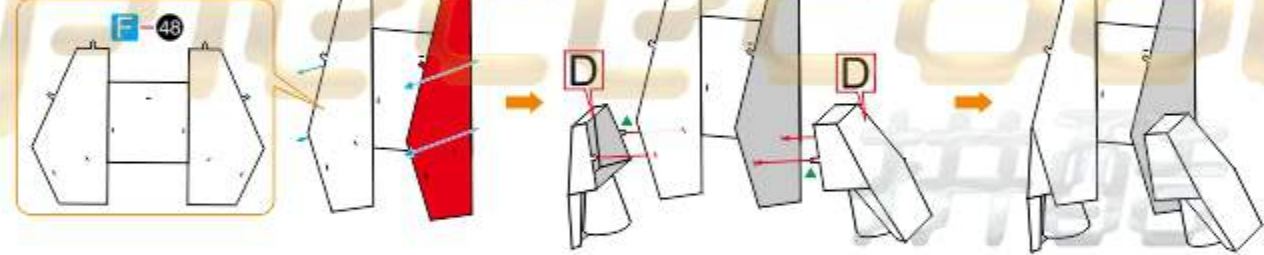
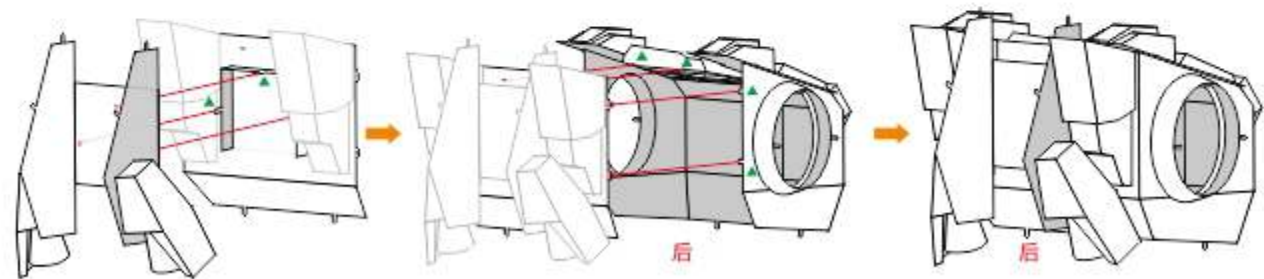
Step.2  
08Step.2  
09Step.2  
10Step.2  
11Step.2  
12Step.2  
13Step.2  
14

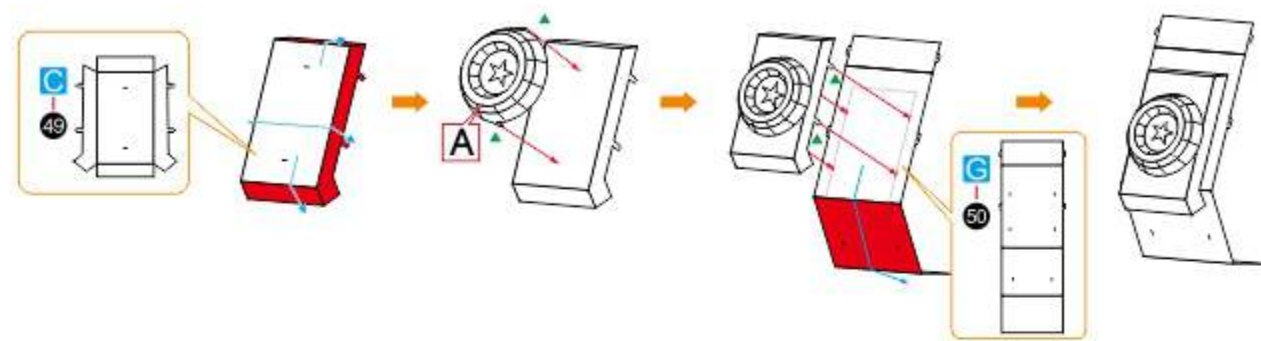
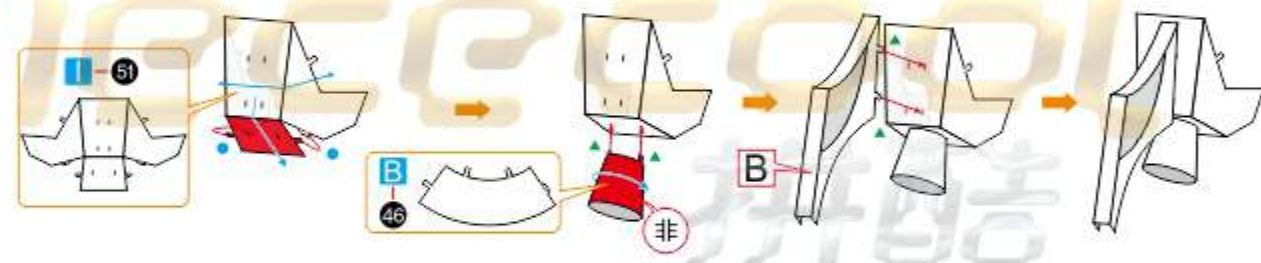
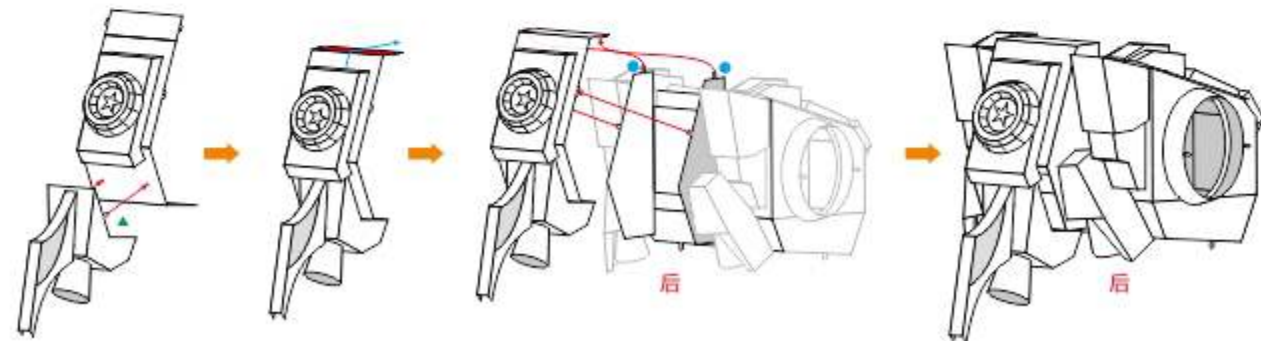
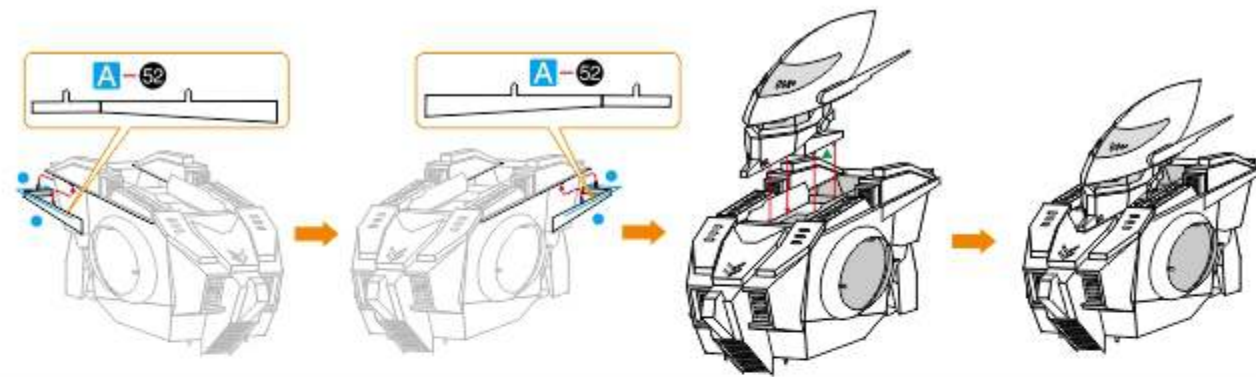
Step.2  
15Step.2  
16Step.2  
17Step.2  
18

Piececool  
拼酷

Piececool  
拼酷

## Step.3 肩部拼装

- 第01小步：零件编号A53,C53,A54,A55,C55
- 第02小步：零件编号G56,I56,A54,F57,G57
- 第03小步：零件编号A58,B58,J59,J60,A61
- 第04小步：零件编号H62,J62,B63,C63
- 第05小步：零件编号H64,I64,H65,I66
- 第06小步：零件编号B67
- 第07小步：零件编号B68,C68
- 第08小步：零件编号H69,I69,C70,A71,B71,B72,K73
- 第09小步：零件编号C70,H74,I74,B75,K76,A77,B77

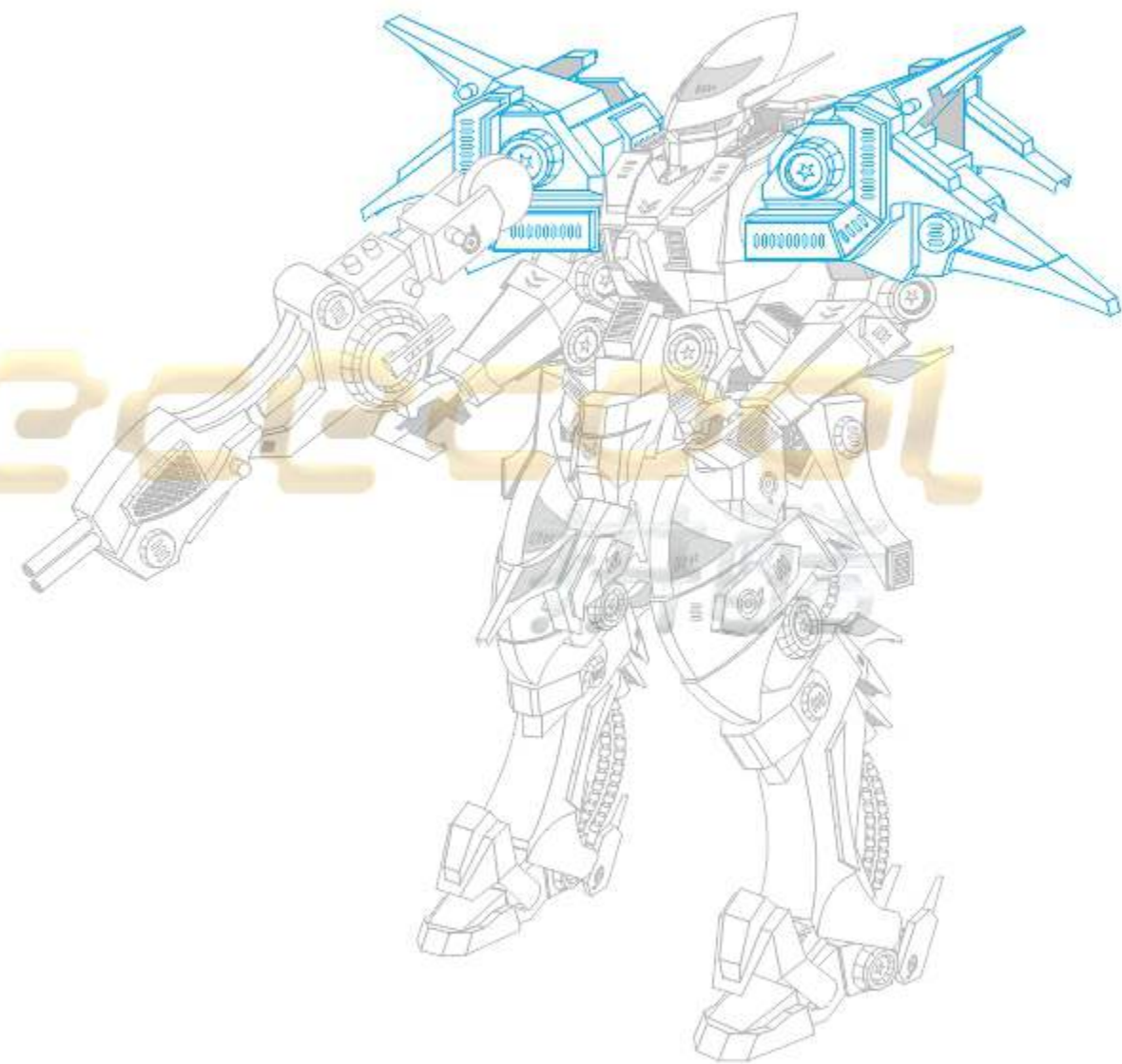
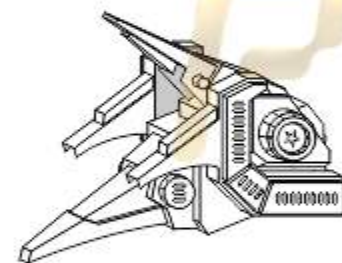

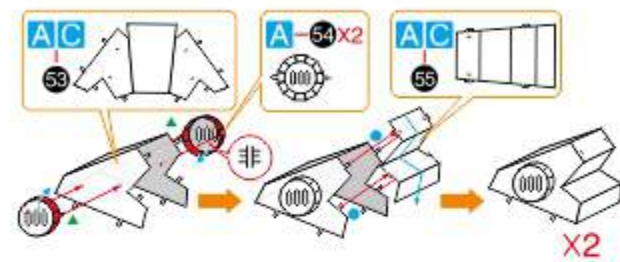
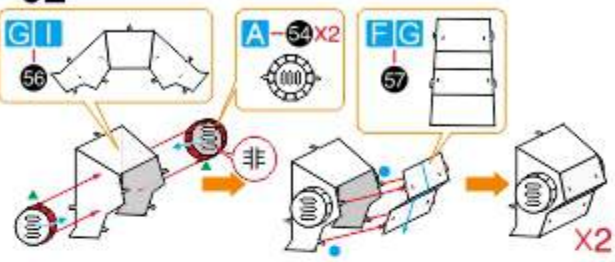
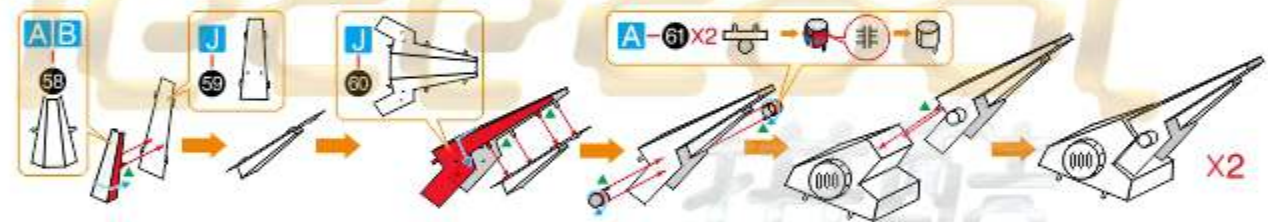
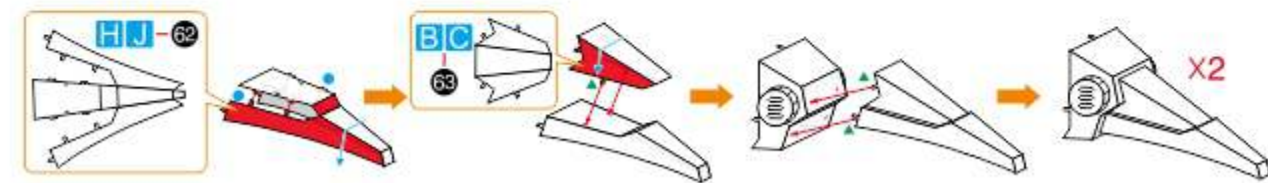
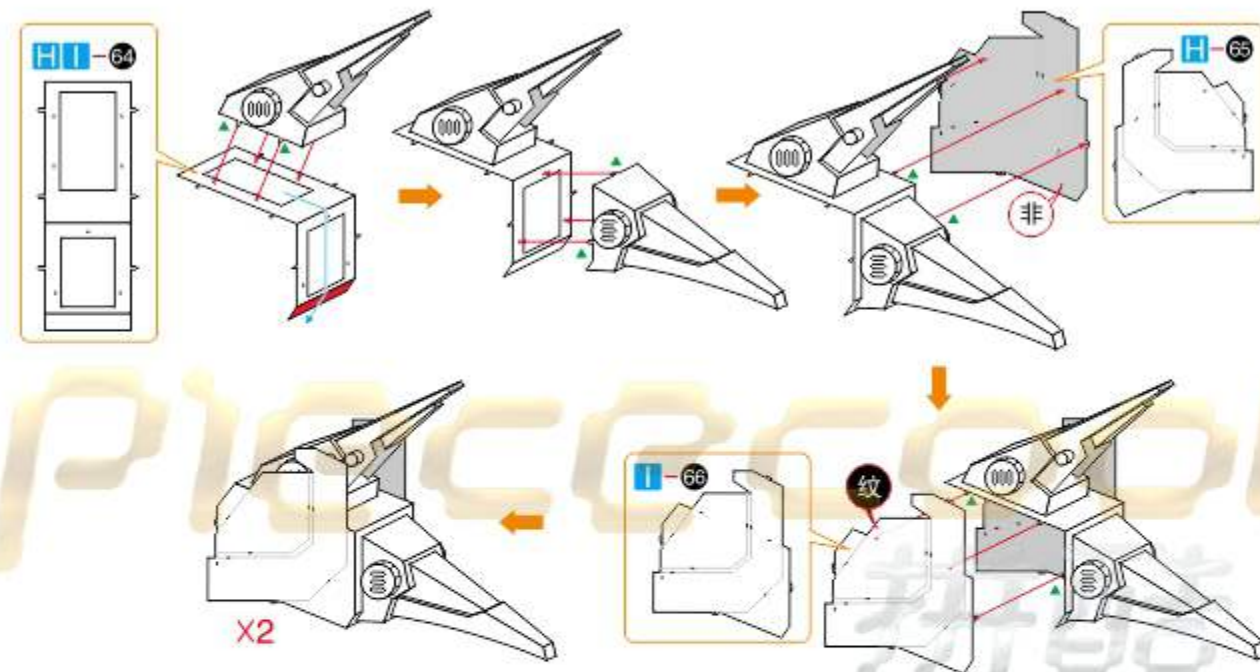
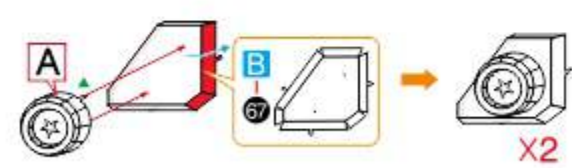
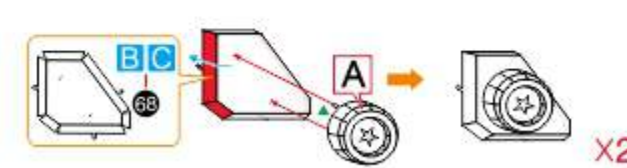
Step.3  
01Step.3  
02Step.3  
03Step.3  
04Step.3  
05Step.3  
06Step.3  
07

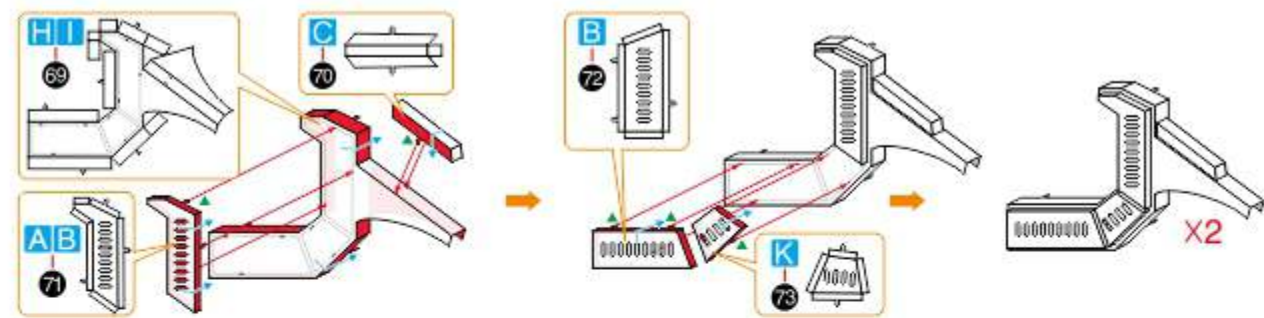
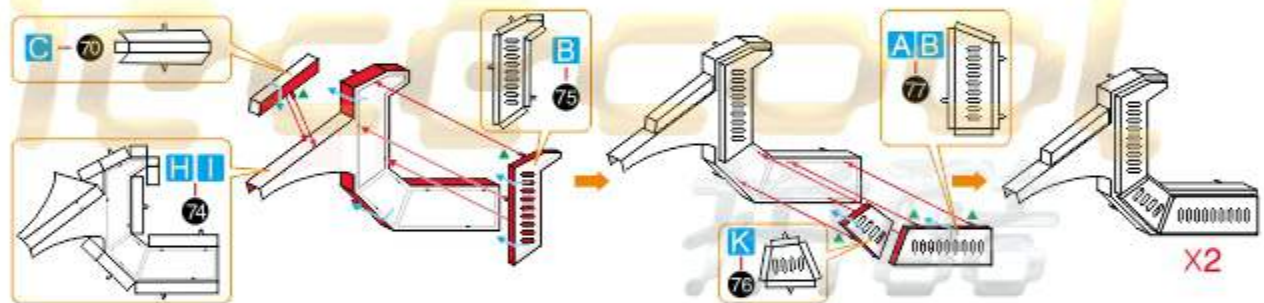
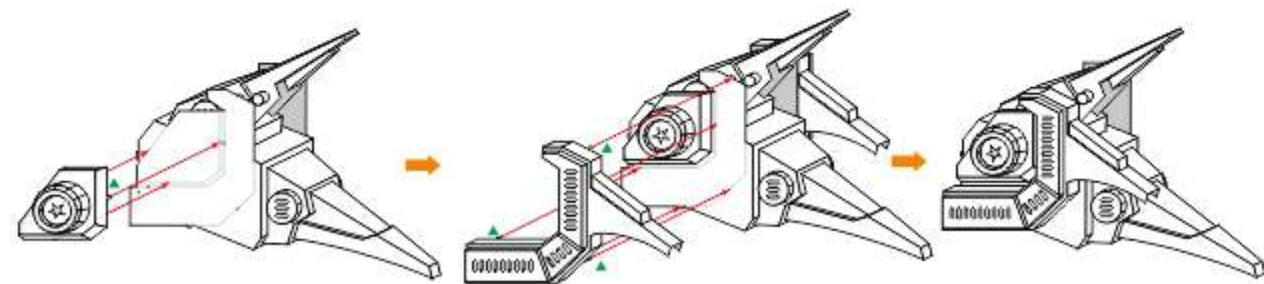
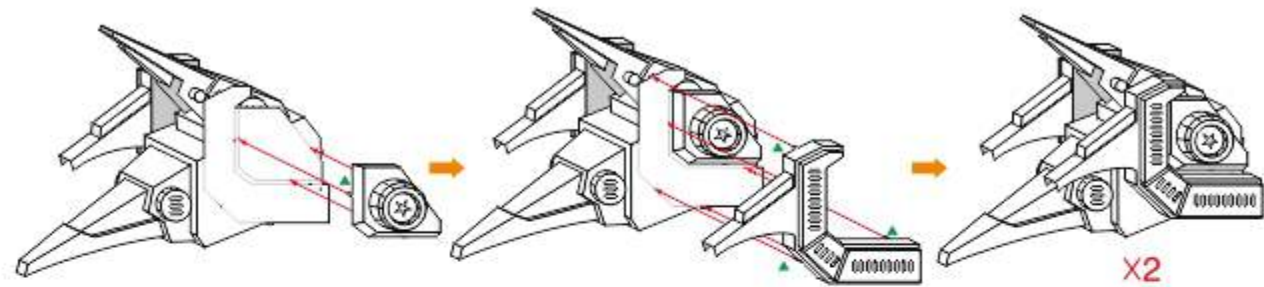
Step.3  
08Step.3  
09Step.3  
10Step.3  
11

Piececool  
拼酷

## Step.4 左臂拼装

- 第01小步：零件编号I78,F80,A79,E81,K82,B83
- 第02小步：零件编号D84,D85,B86,E87,L87,D88
- 第03小步：零件编号G89,B90,J91
- 第04小步：零件编号D92,E93,G94,J95
- 第05小步：零件编号A96,B96,C98,E97,G97
- 第06小步：零件编号B99

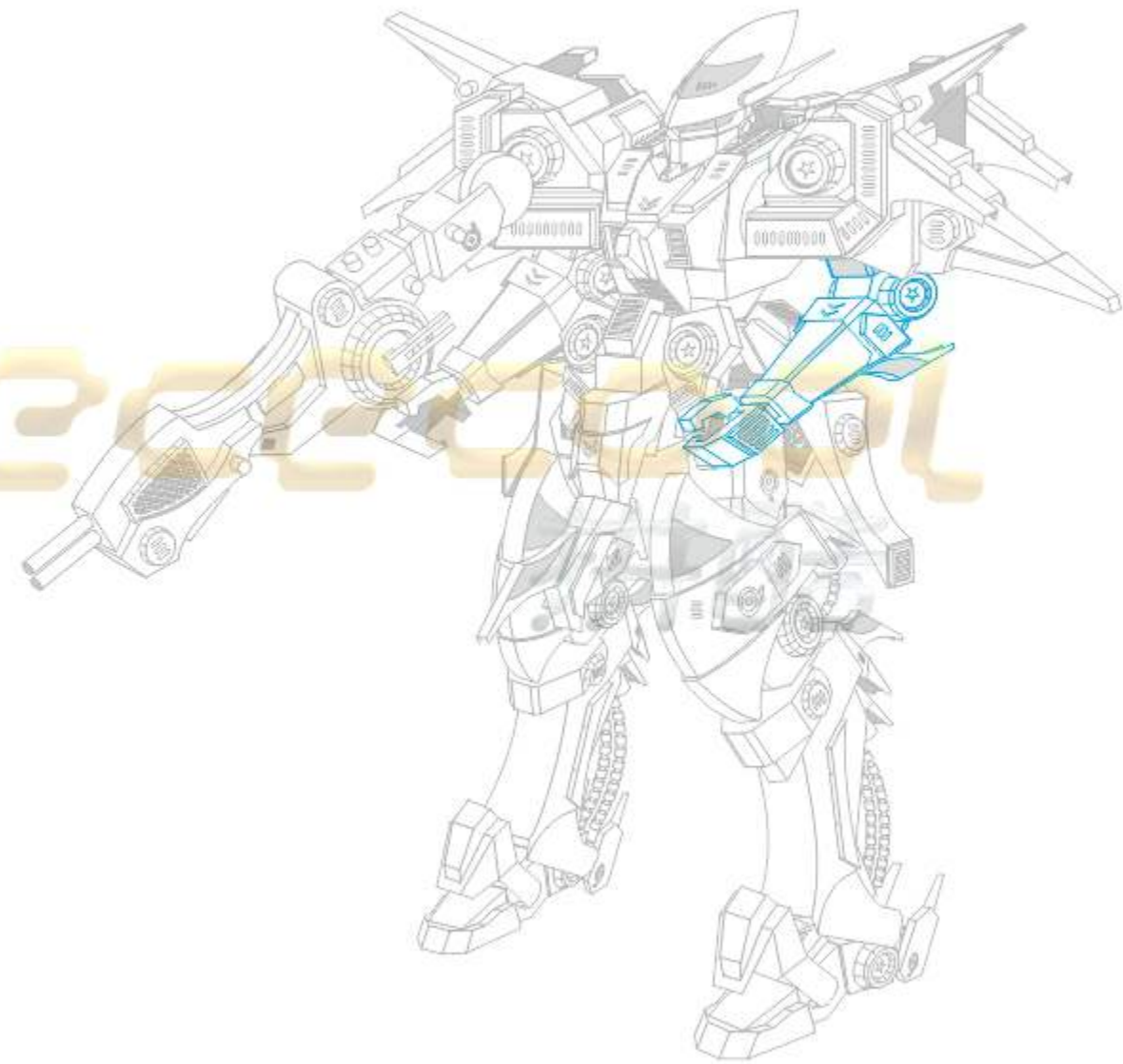
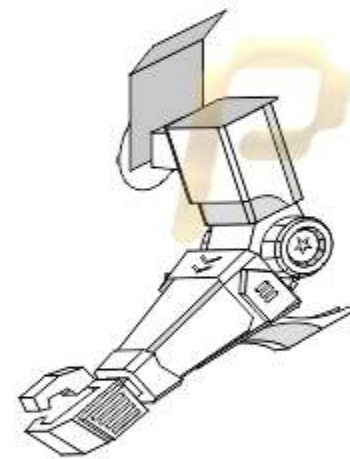

Step.4  
01

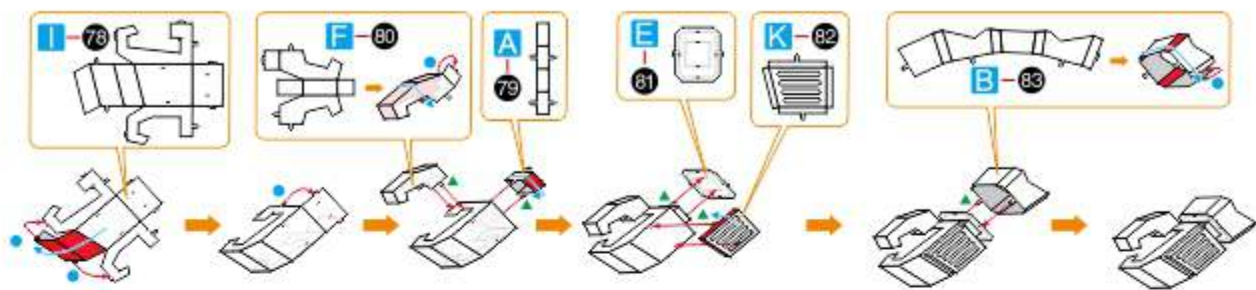

Step.4  
02

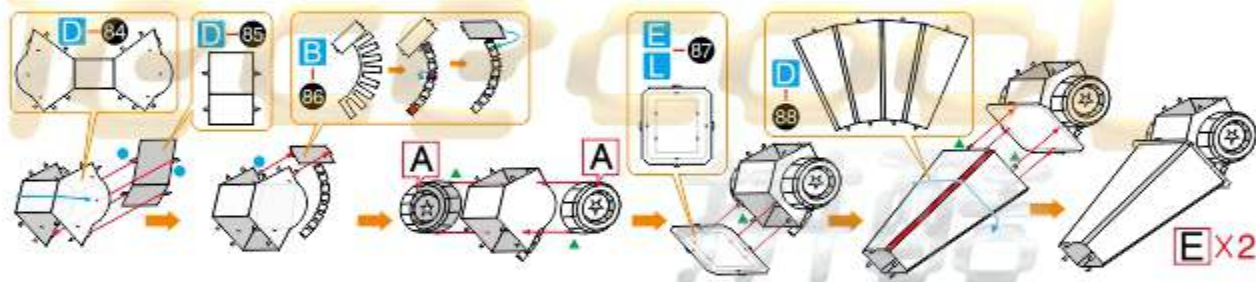

Step.4  
03

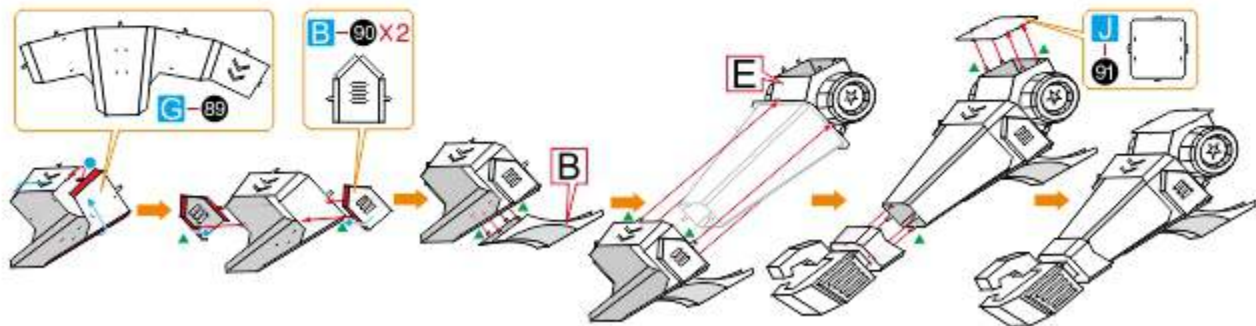

Step.4  
04

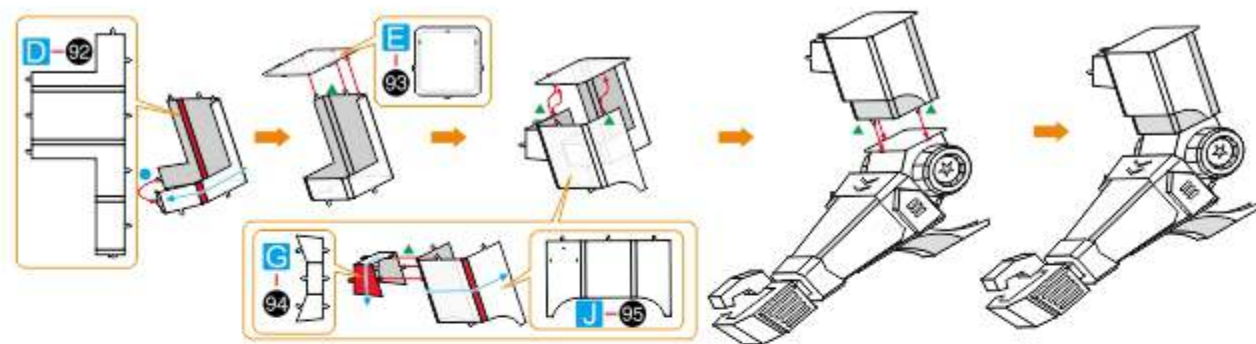

Step.4  
05

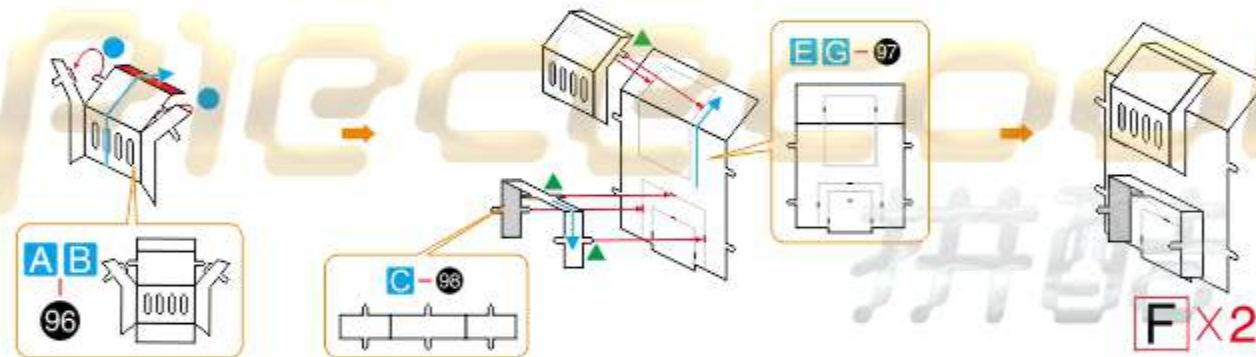

Step.4  
06

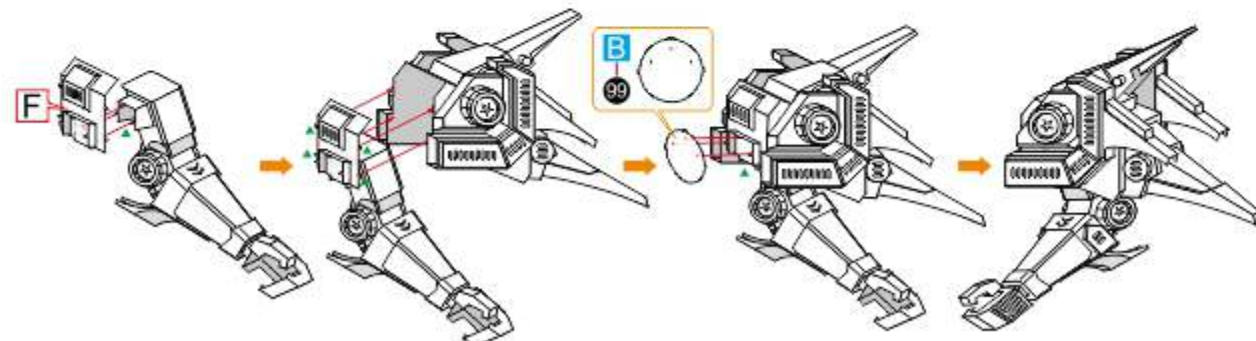



Piececool  
拼酷

## Step.5 右臂拼装

第01小步：零件编号H100,A79,L80,K101,G81,B102  
第02小步：零件编号G103,B90,J91  
第03小步：零件编号D92,J93,E104,G94,B99

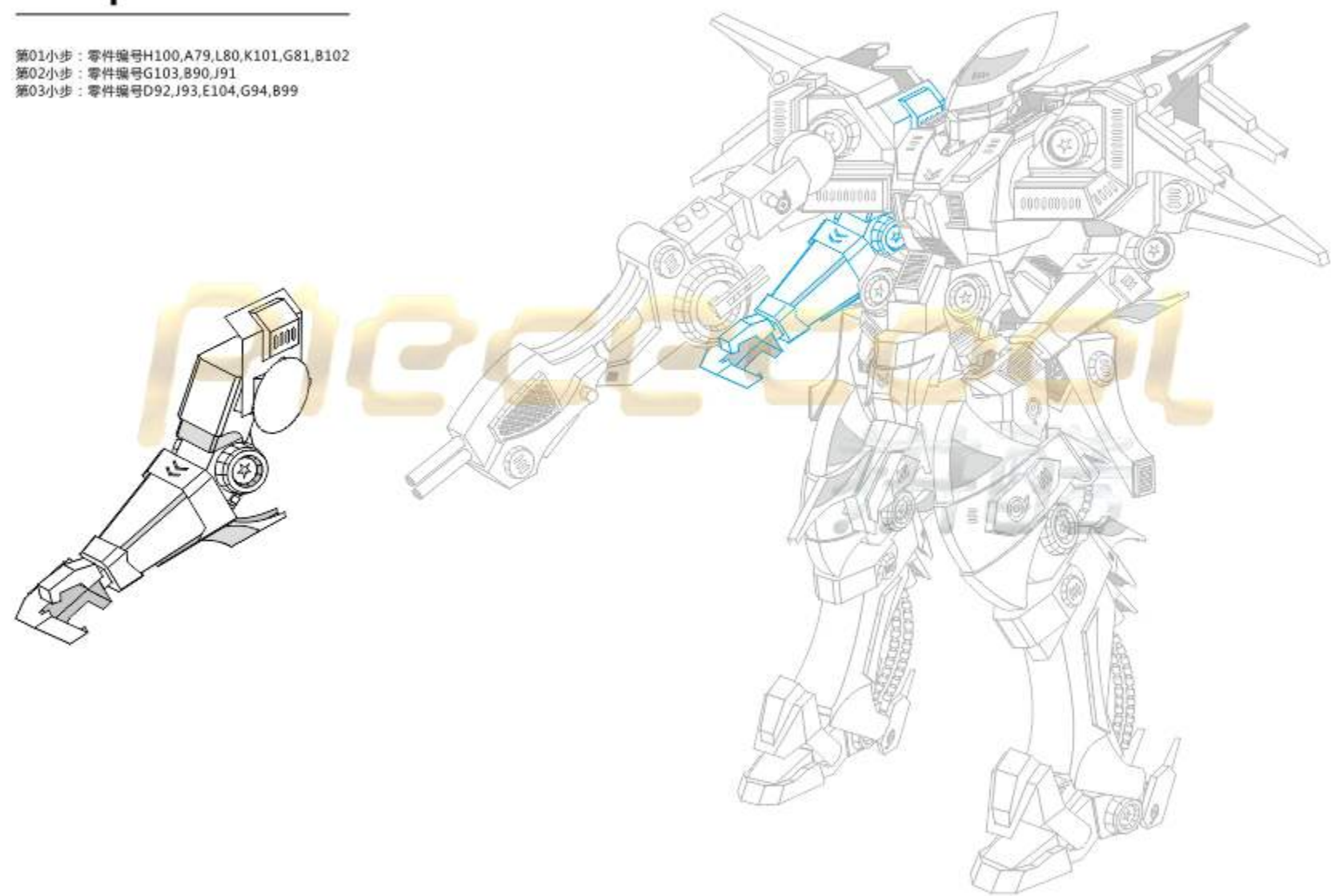

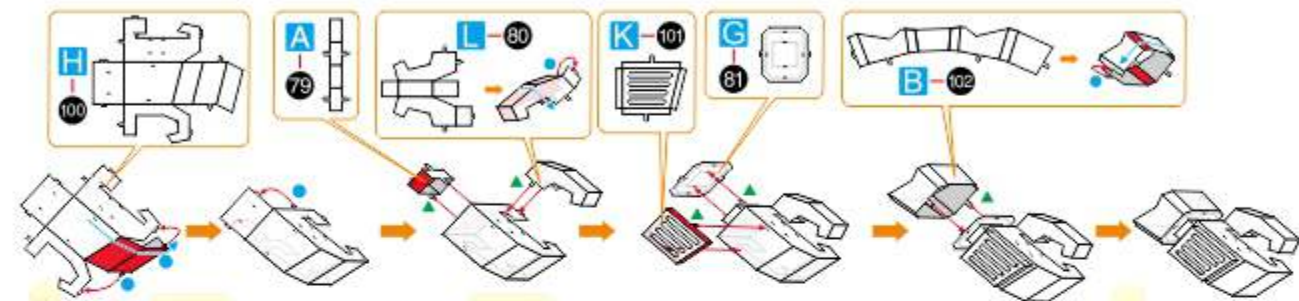
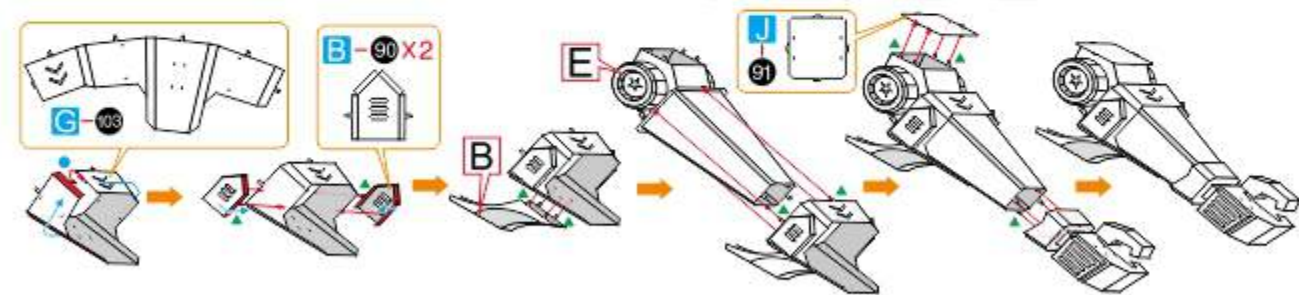
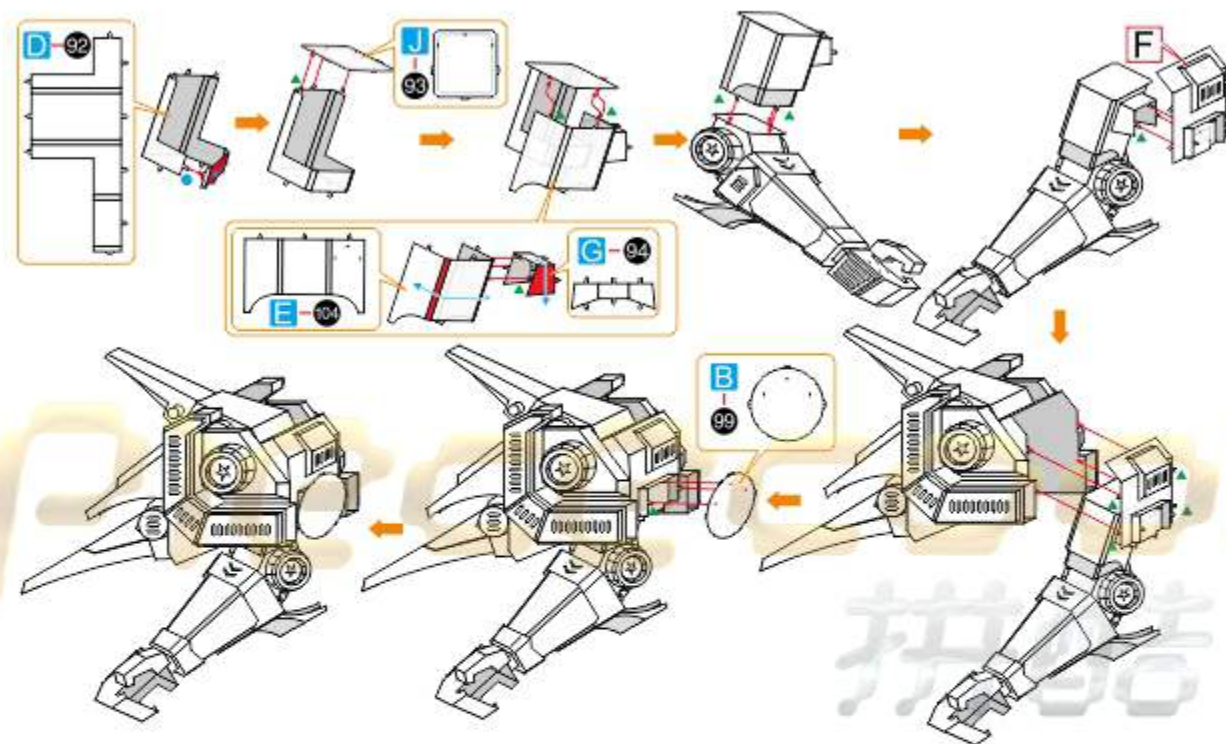
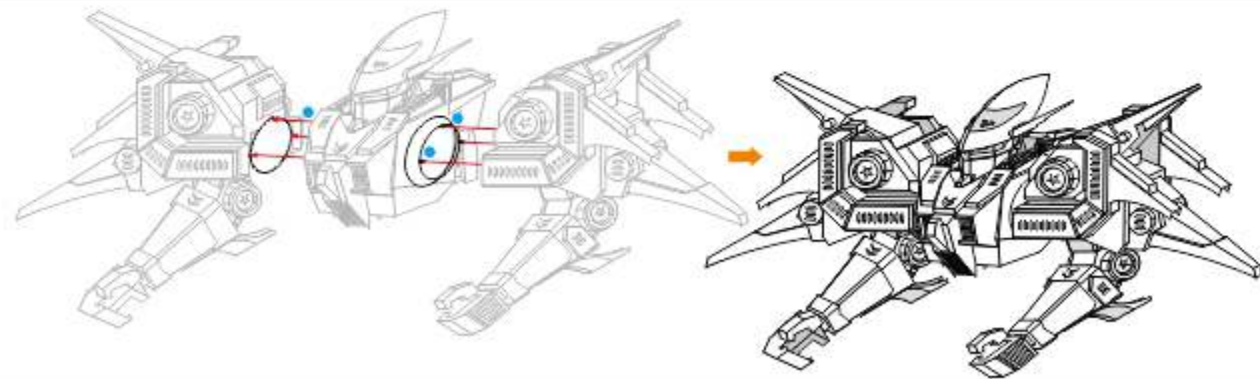
Step.5  
01Step.5  
02Step.5  
03Step.5  
04

Piececool  
拼酷

## Step.6 左腿拼装

- 第01小步：零件编号F105,J105,F106,G106,A107,B107
- 第02小步：零件编号A108,B108,E109,L109
- 第03小步：零件编号A111,C111,F110
- 第04小步：零件编号A112,J113,A114,C115,A116,A117,C117
- 第05小步：零件编号D118,E119
- 第06小步：零件编号D120
- 第07小步：零件编号G121,J121,A61,B61
- 第08小步：零件编号J122
- 第09小步：零件编号D123,D125,D124
- 第10小步：零件编号F126,C127,B128,C128
- 第11小步：零件编号E129,I129,C130,B131,C131
- 第12小步：零件编号F132
- 第13小步：零件编号G133,J133,B134

- 第14小步：零件编号H135
- 第15小步：零件编号A136,D137,D138
- 第16小步：零件编号D139,E140,F140
- 第17小步：零件编号A54,H141,A142,B142
- 第19小步：零件编号I143
- 第20小步：零件编号D144,E145,H147,J147,D146
- 第21小步：零件编号I148,F149,E150
- 第22小步：零件编号C90,J151,I145
- 第23小步：零件编号J152,C90,L145,J145
- 第24小步：零件编号H153,I153,F154,H154
- 第25小步：零件编号G155,A156,B156,B157,C157
- 第26小步：零件编号A158,B159
- 第27小步：零件编号H160

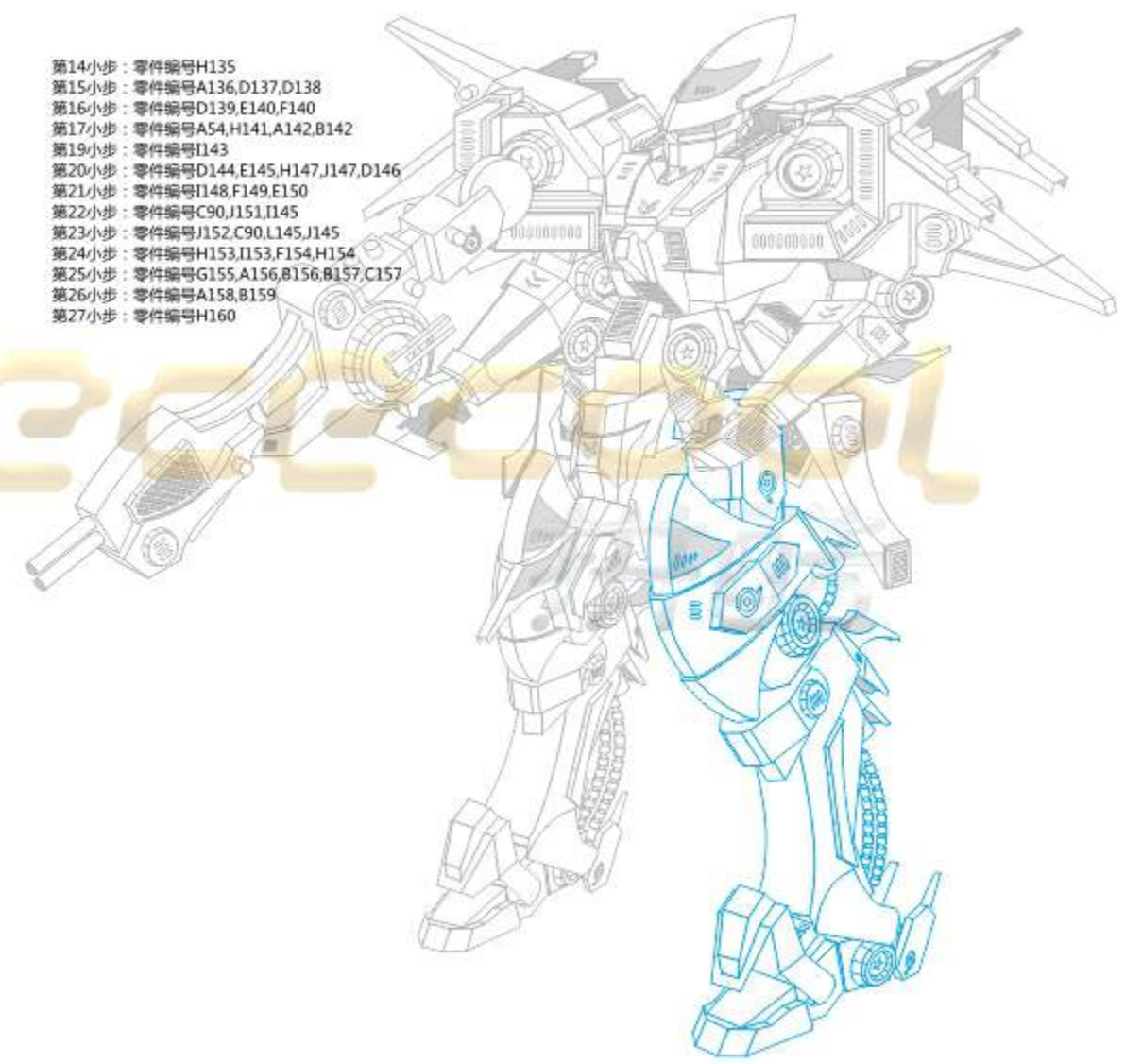
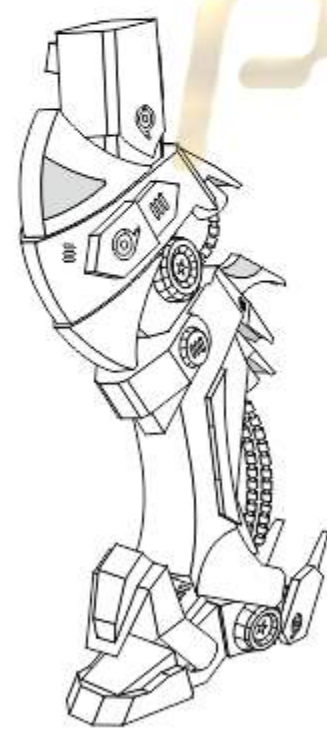

Step.6  
01

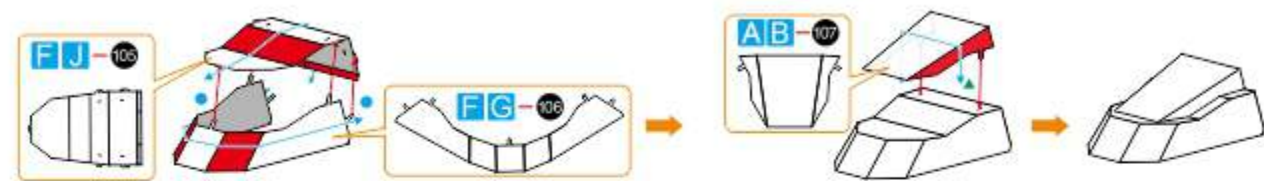

Step.6  
02

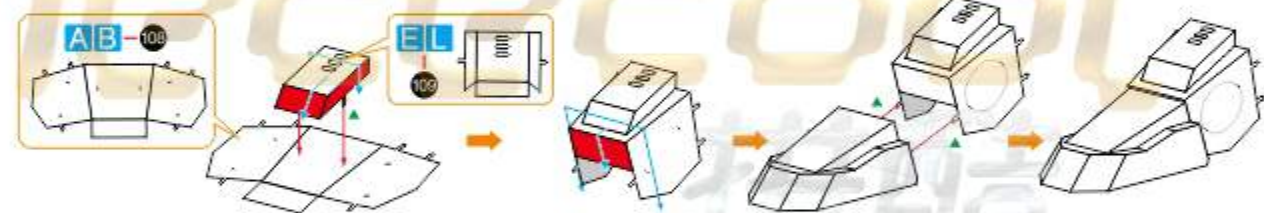

Step.6  
03

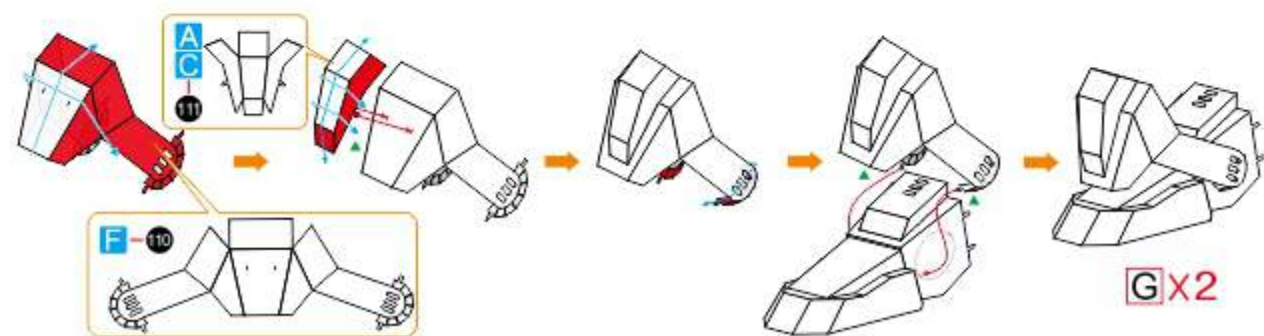

Step.6  
04

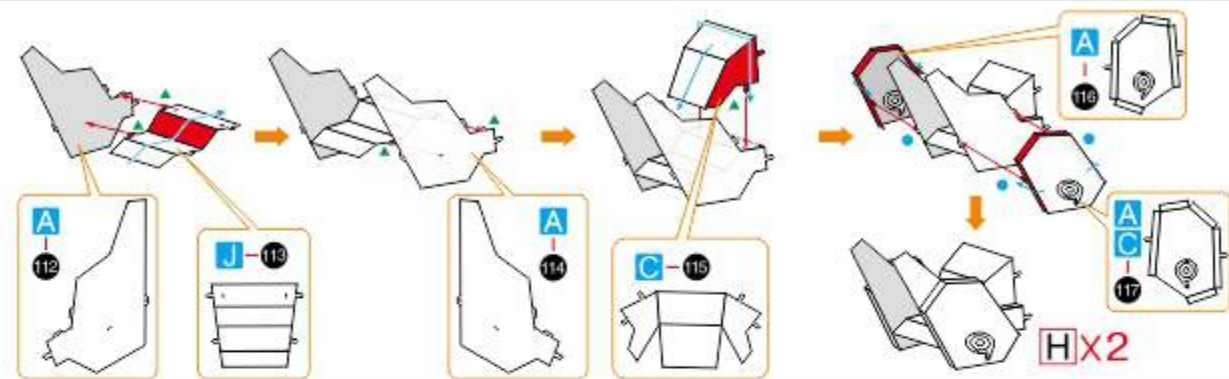

Step.6  
05

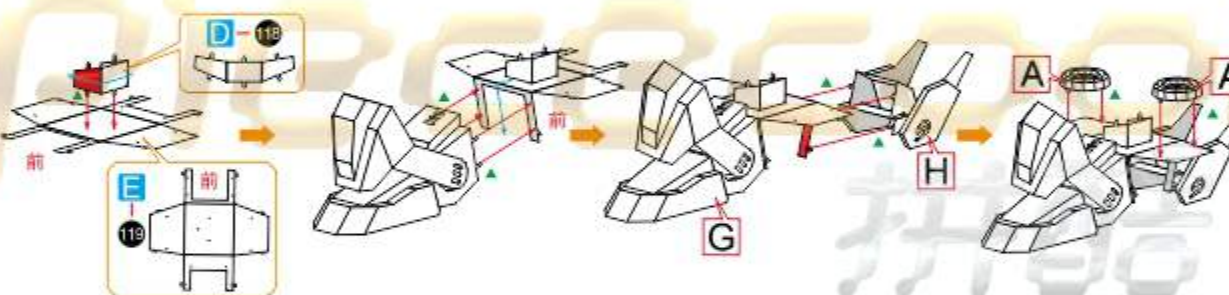

Step.6  
06

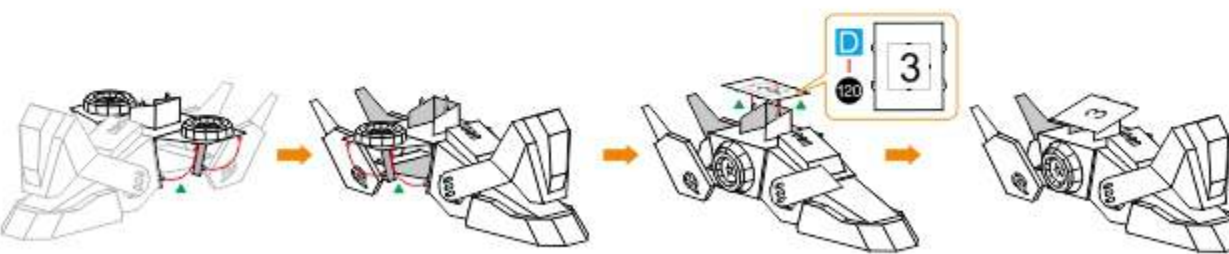

Step.6  
07

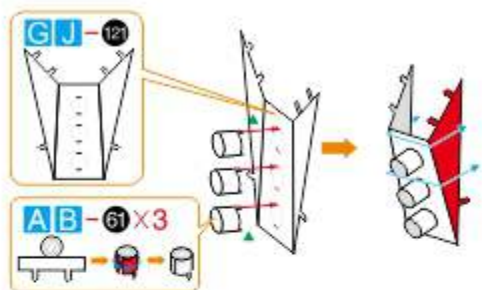

Step.6  
08

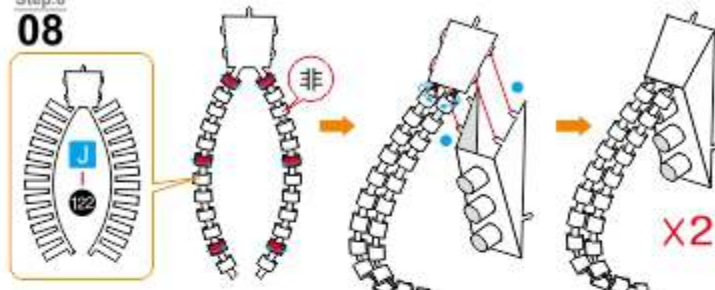

Step.6  
09

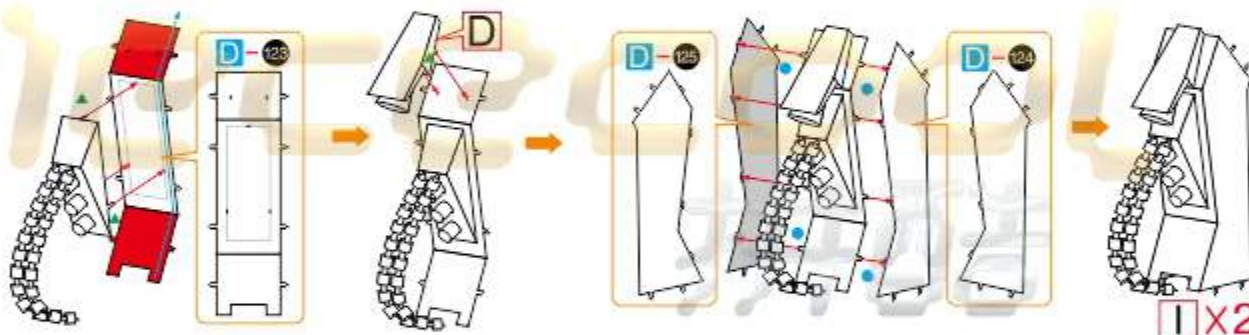

Step.6  
10

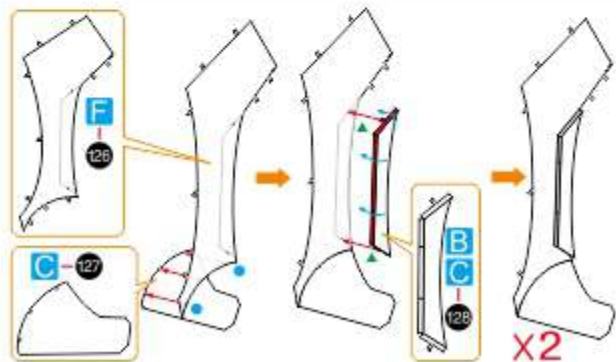

Step.6  
11

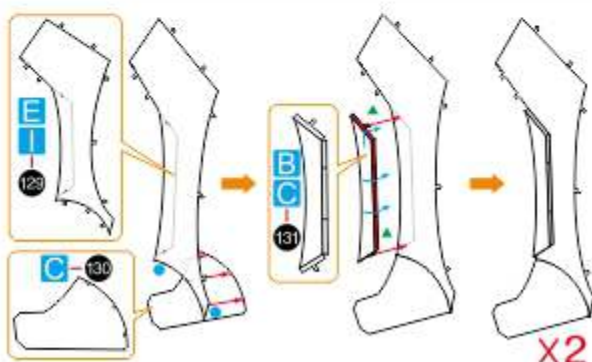

Step.6  
12

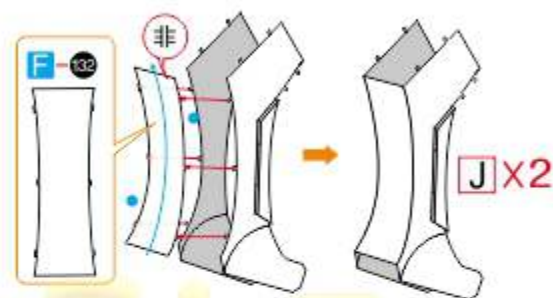

Step.6  
13

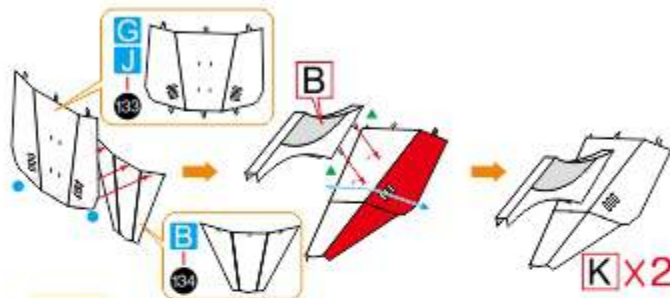

Step.6  
14

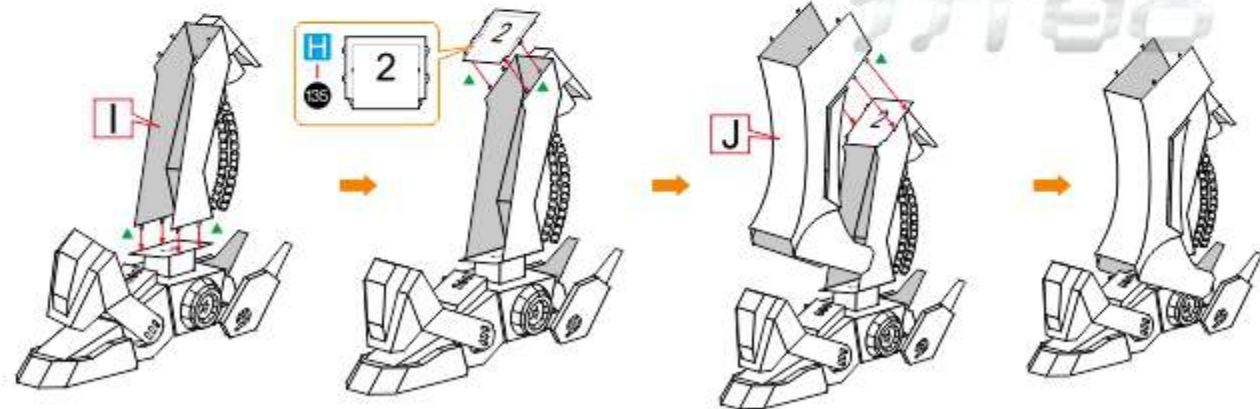

Step.6  
15

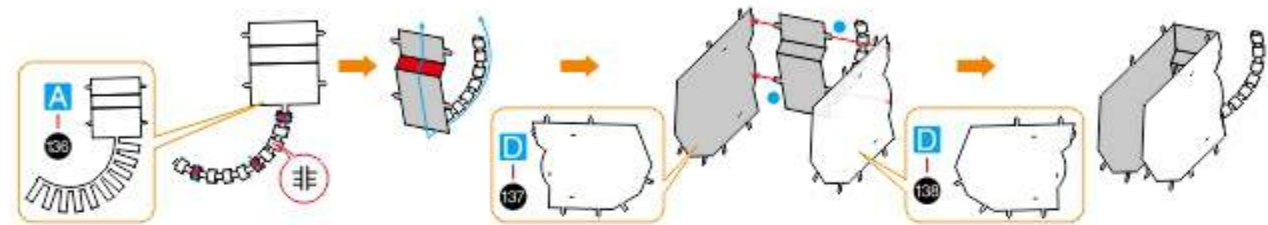

Step.6  
16

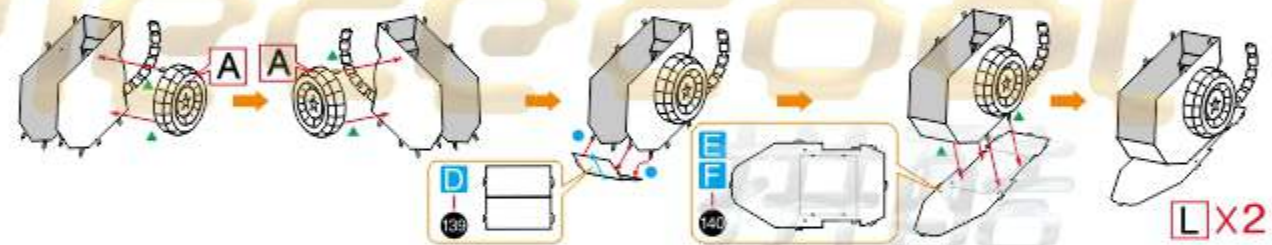

Step.6  
17

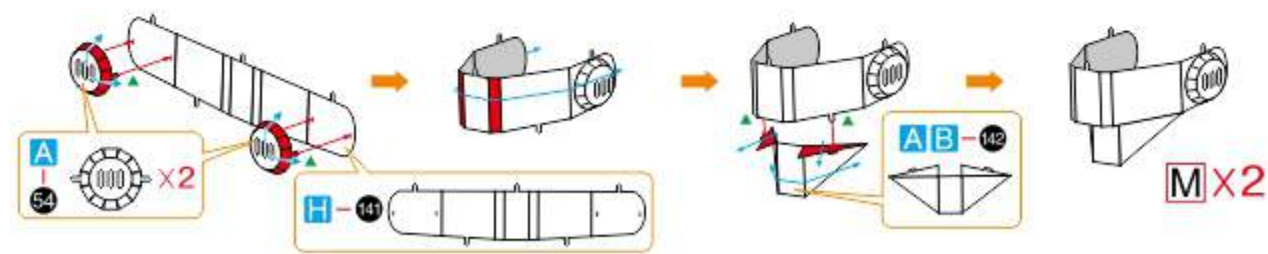

Step.6  
18

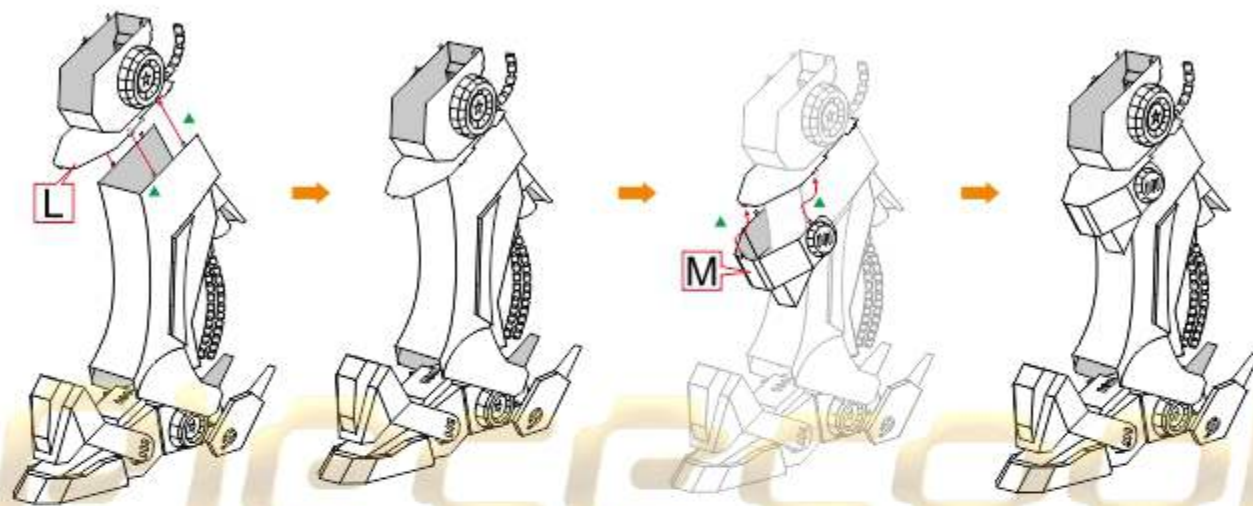

Step.6  
19

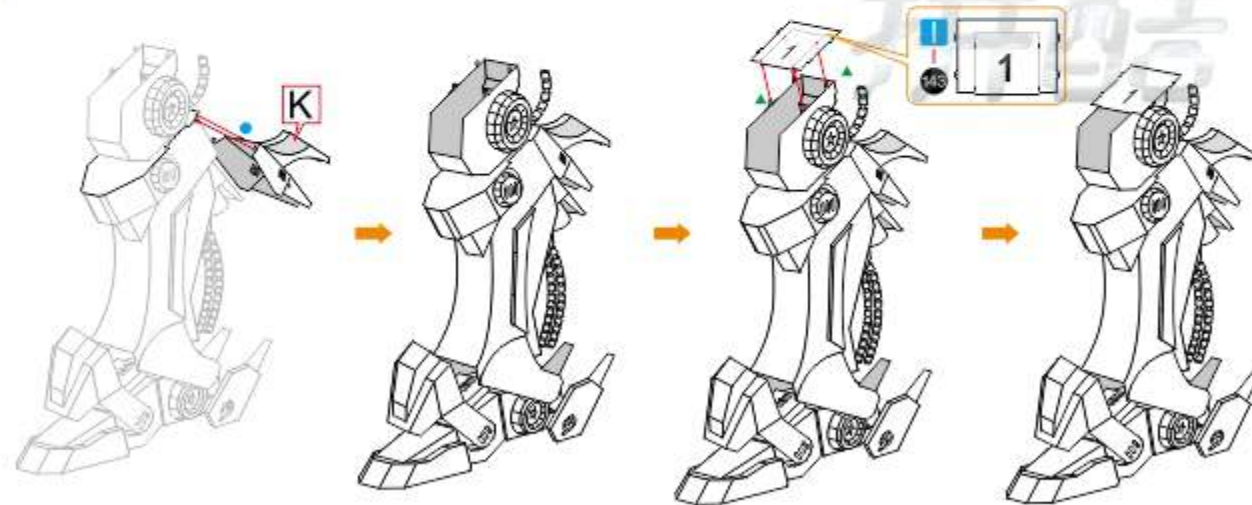

Step.6  
20

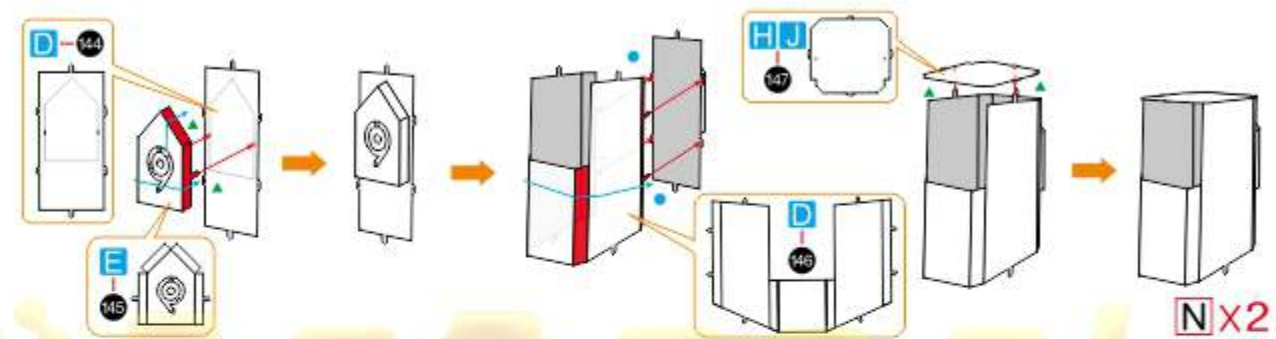

Step.6  
21

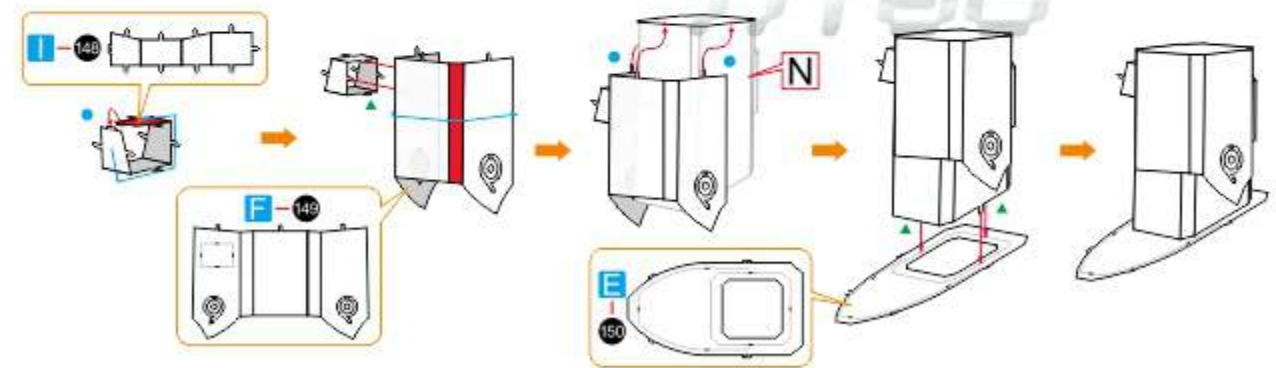

Step.6  
22

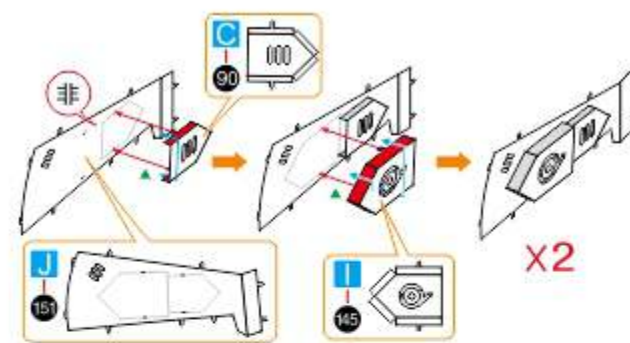

Step.6  
23

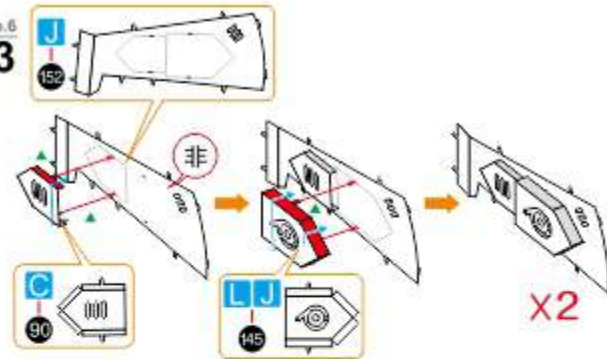

Step.6  
24

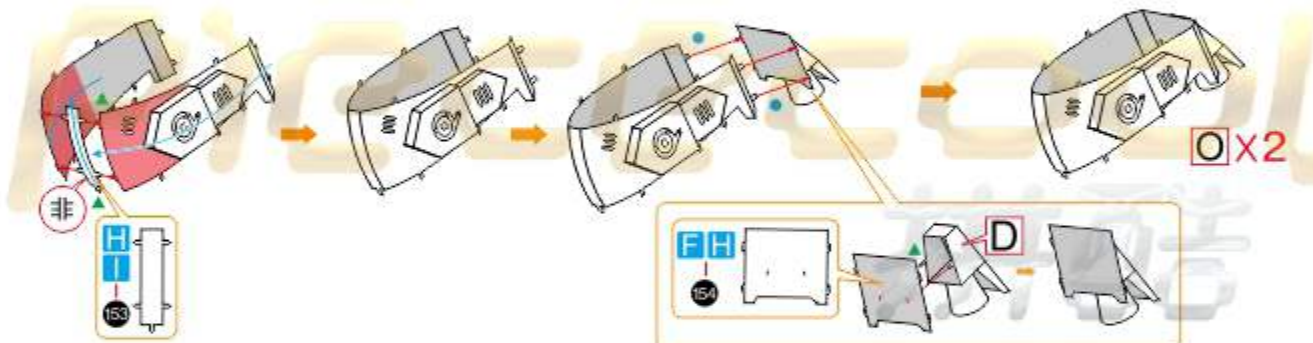

Step.6  
25

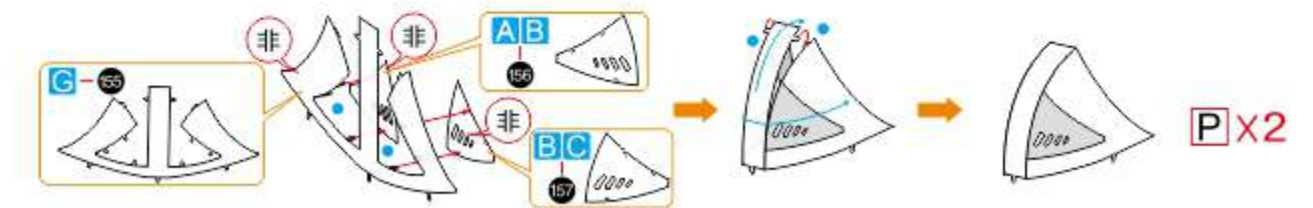

Step.6  
右腿拼装

Step.6  
左腿拼装

Step.6  
26

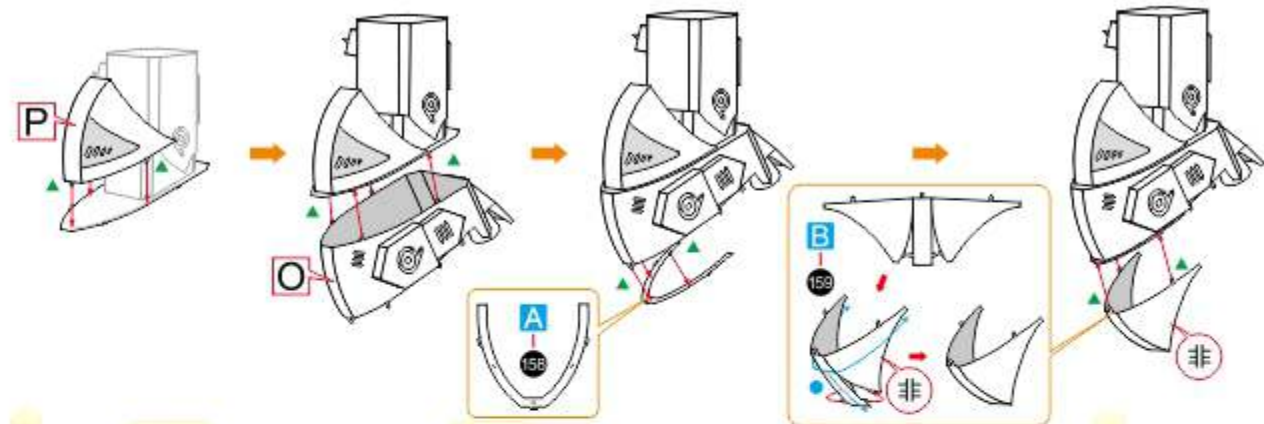

Step.6  
27

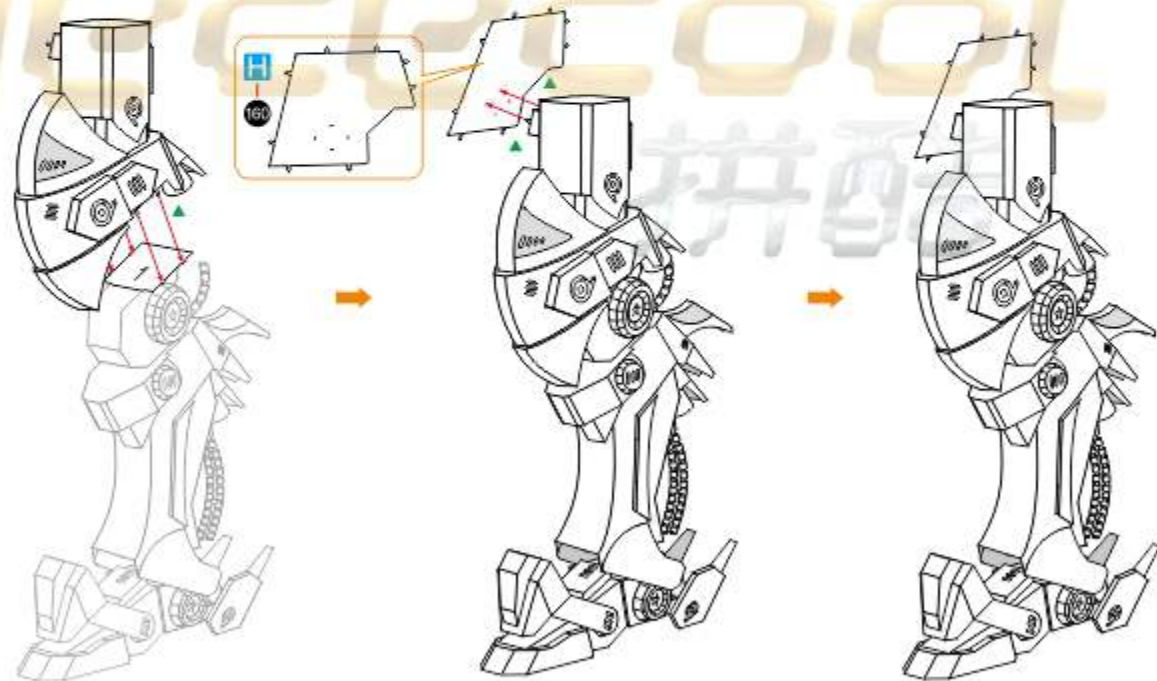

## Step.7 右腿拼装

- 第01小步：零件编号D118,E161
- 第02小步：零件编号D120
- 第03小步：零件编号E135
- 第05小步：零件编号I143
- 第06小步：零件编号I148,E162,G150
- 第07小步：零件编号K158,C159
- 第08小步：零件编号F163

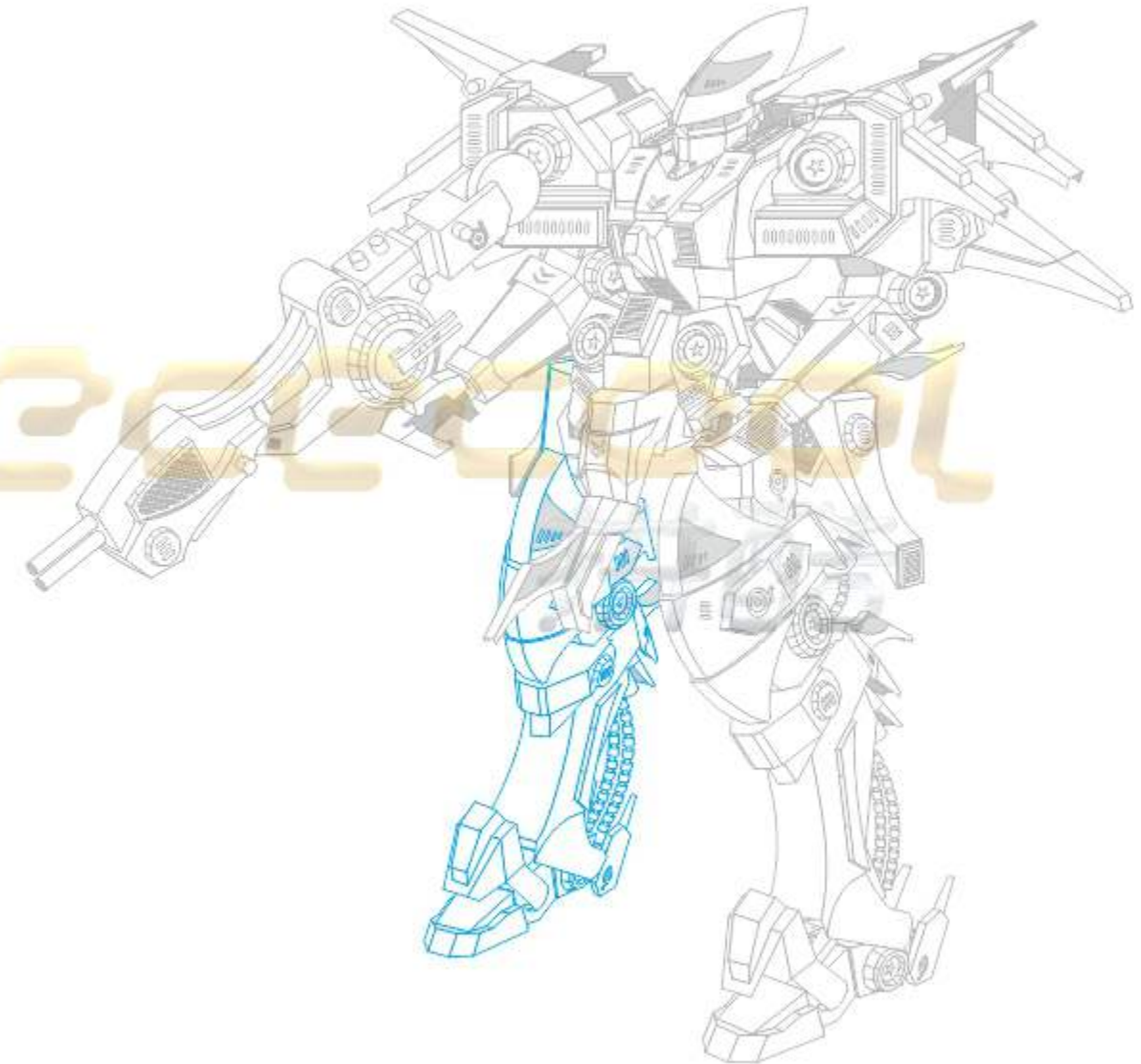
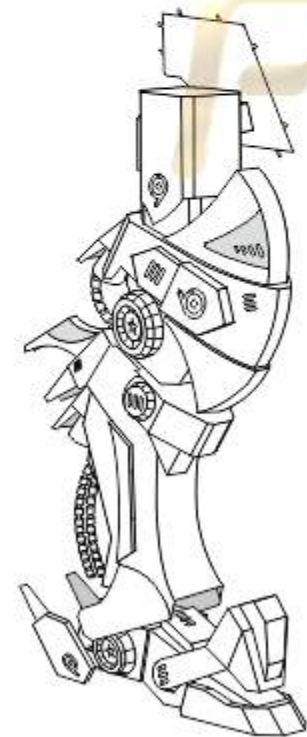

Step.6  
右腿拼装



Step.7  
01

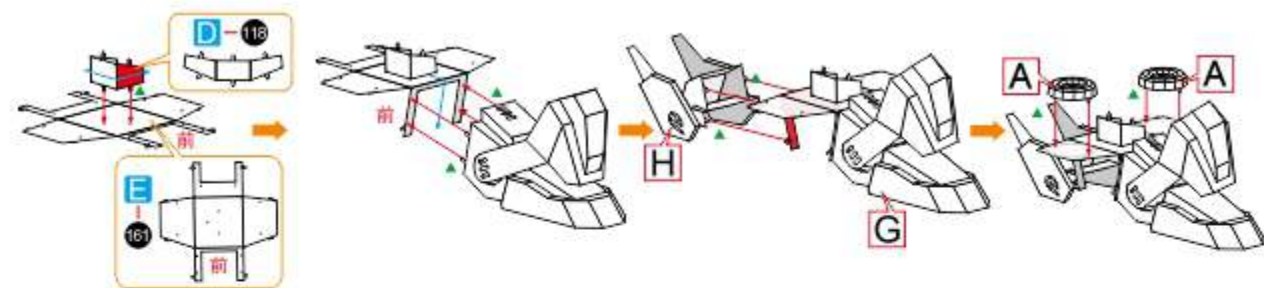

Step.7  
02

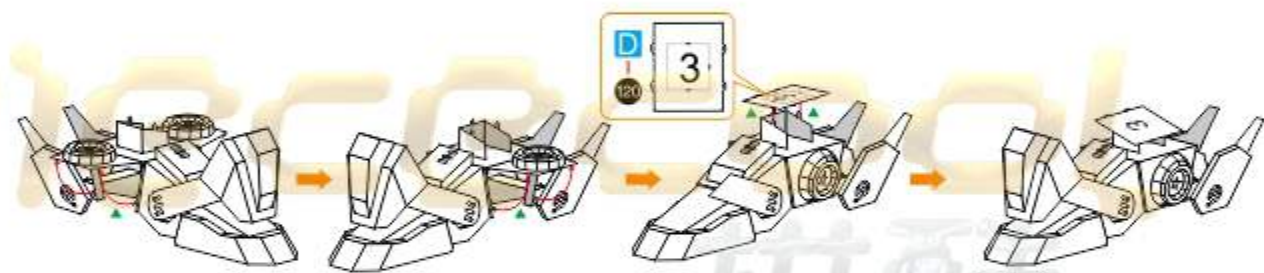

Step.7  
03

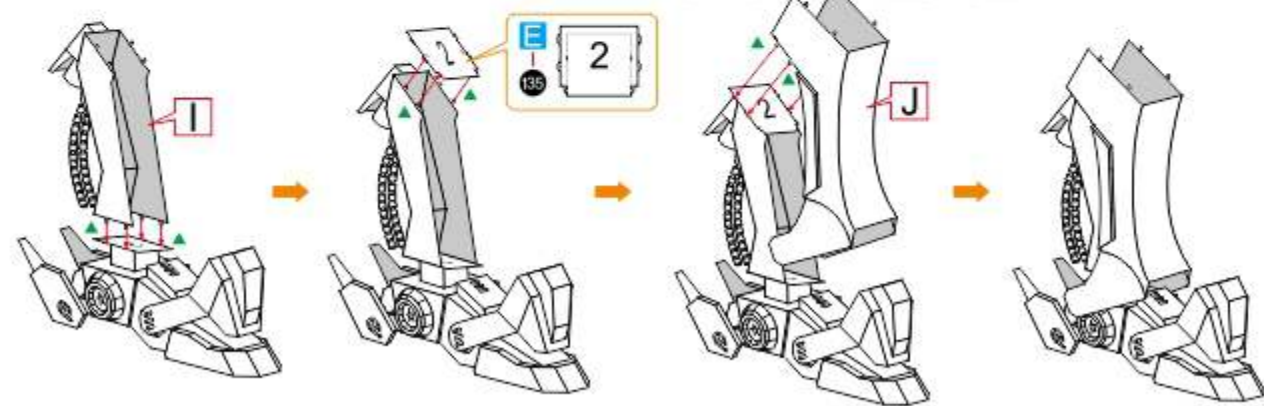

Step.7  
04

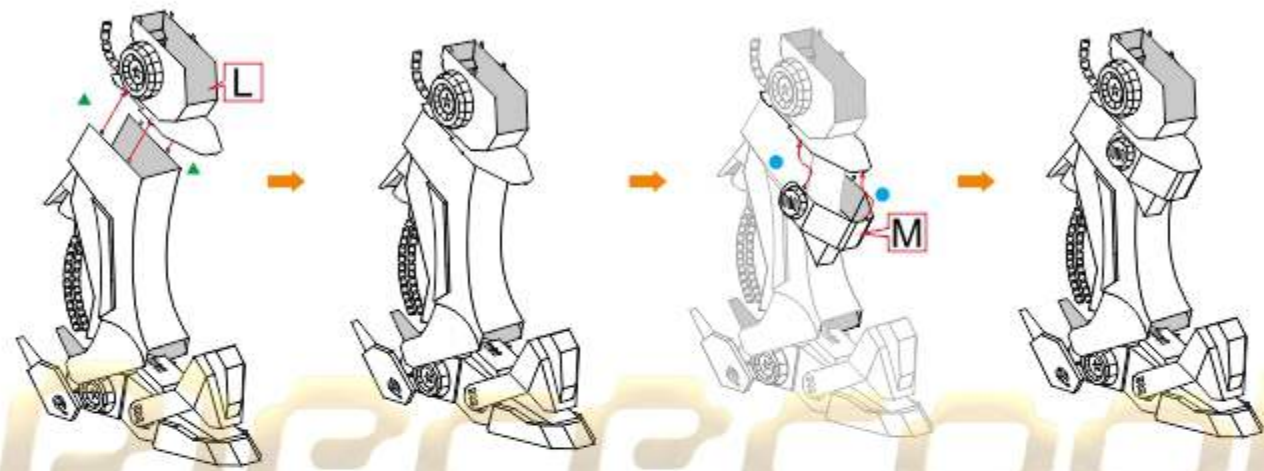

Step.7  
05

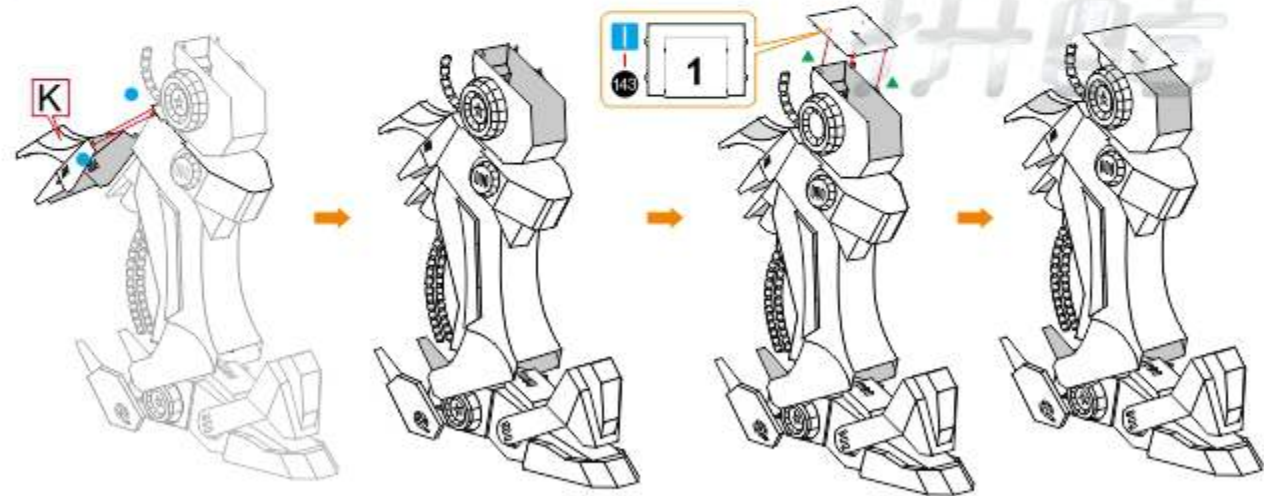

Step.7  
06

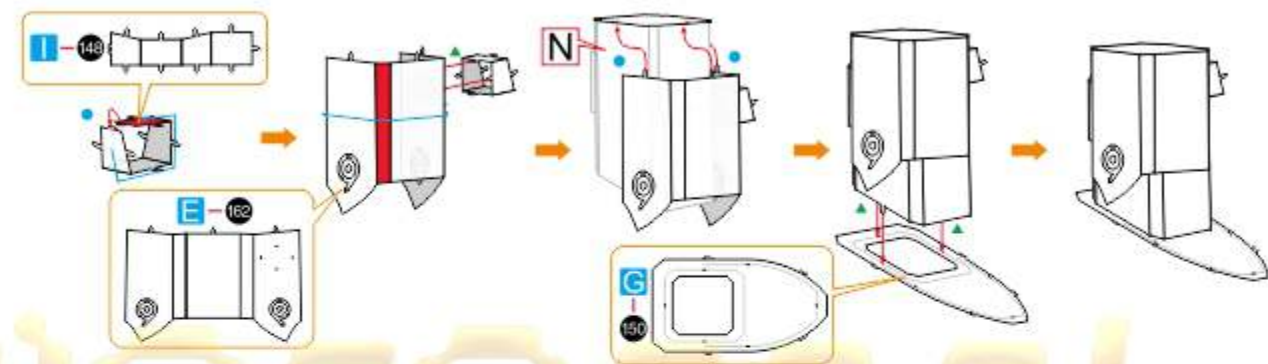

Step.7  
07

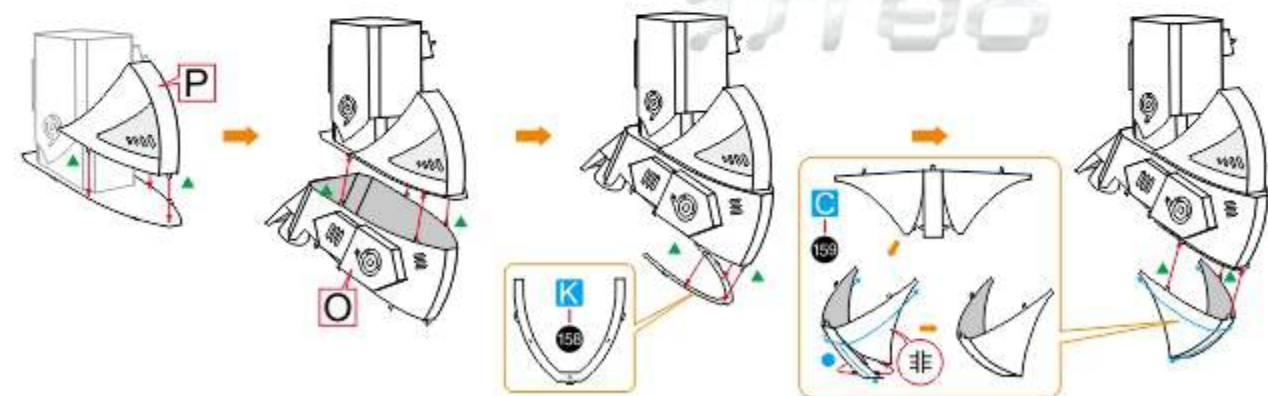

Step.7  
08

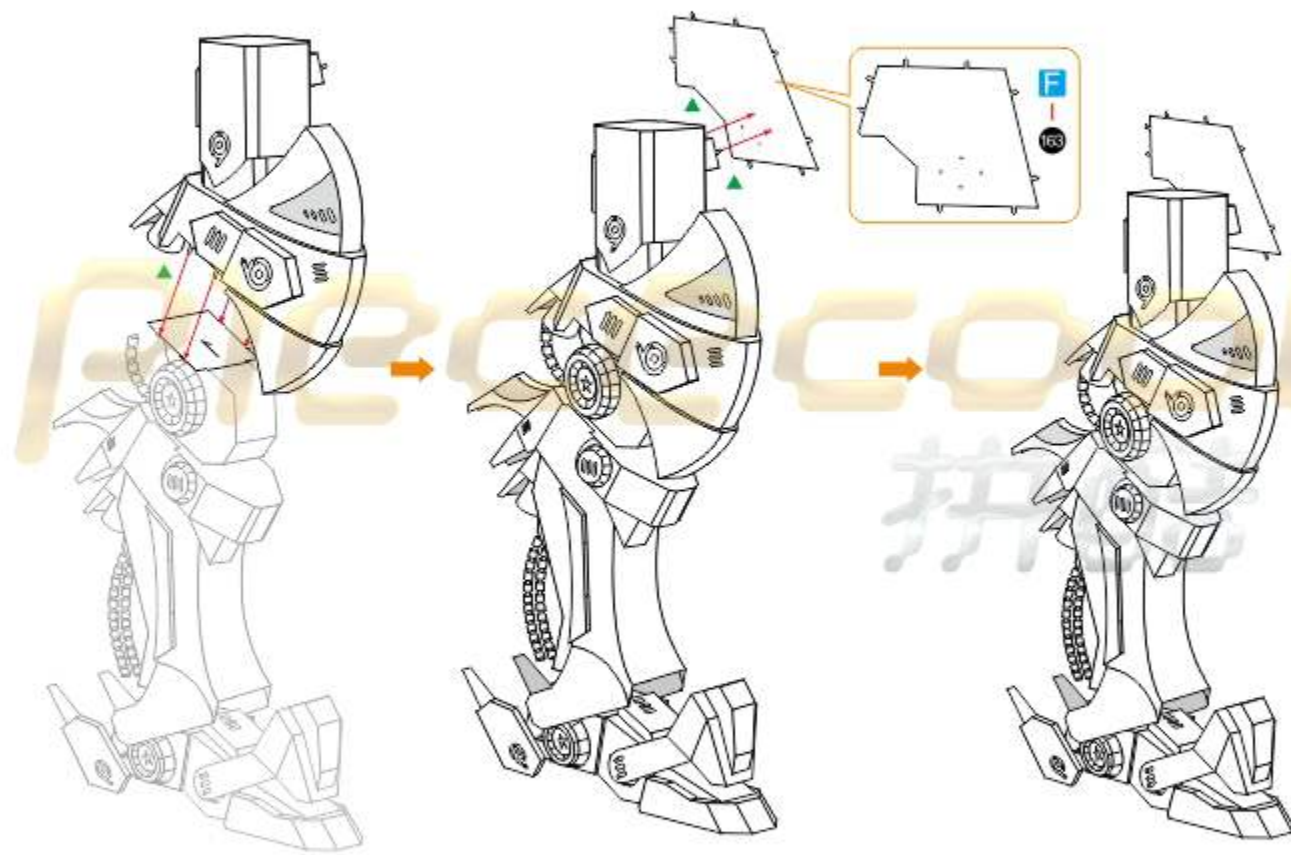

Piececool  
拼酷

## Step.8 腰部拼装

第01小步：零件编号F164,G165,G166,F167  
第02小步：零件编号E168,I168,G169,I169  
第03小步：零件编号H170,I170,A171,A172  
第04小步：零件编号I173,G174,I174,I174,A175,A54,B54  
第05小步：零件编号G176

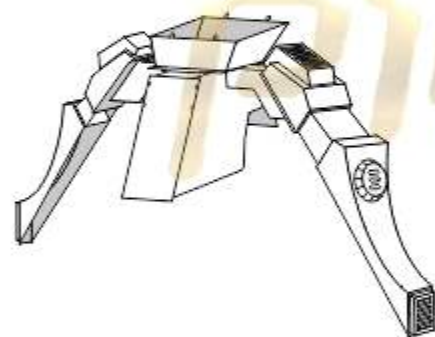

Step.8  
01

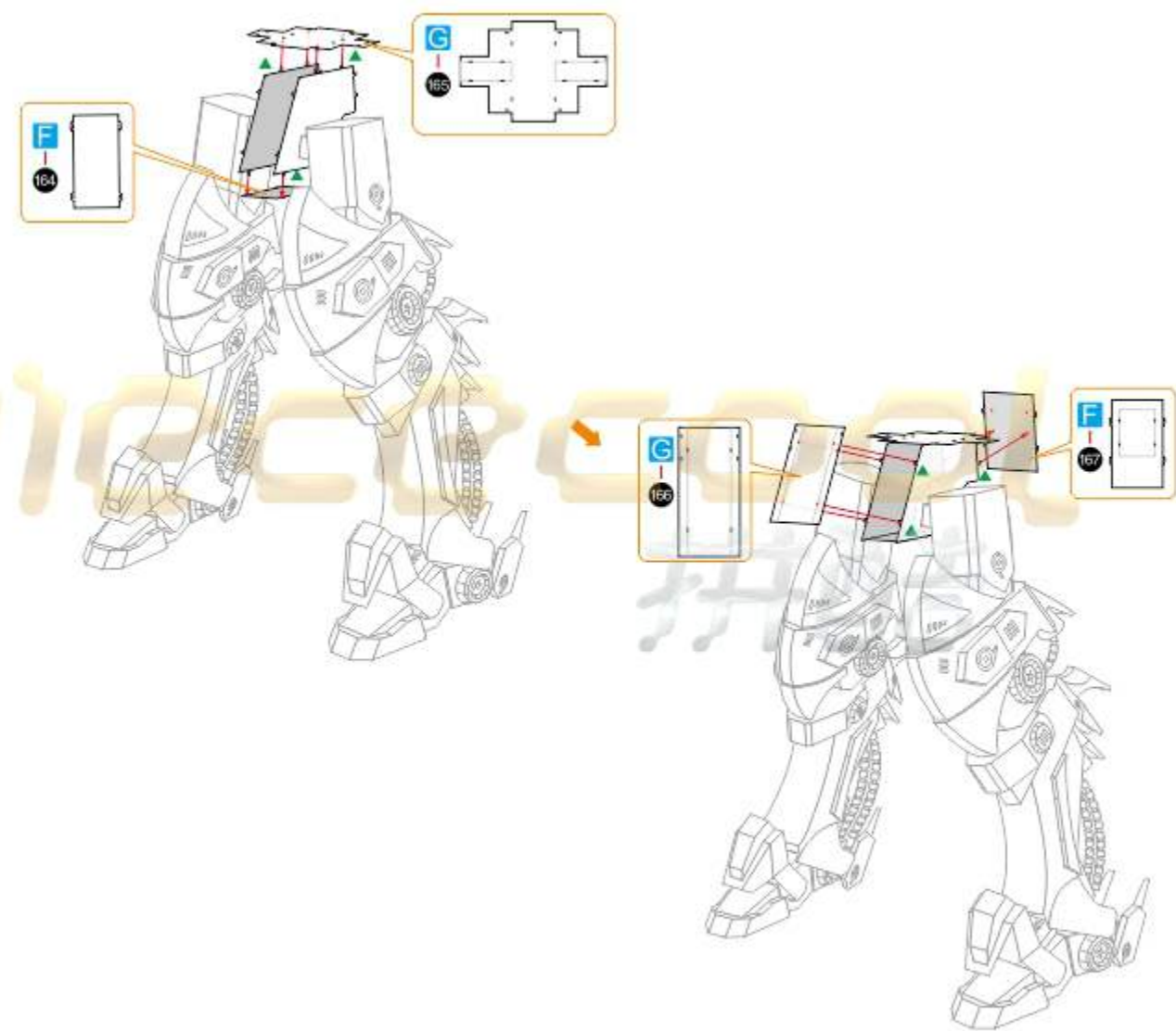

Step.8  
02

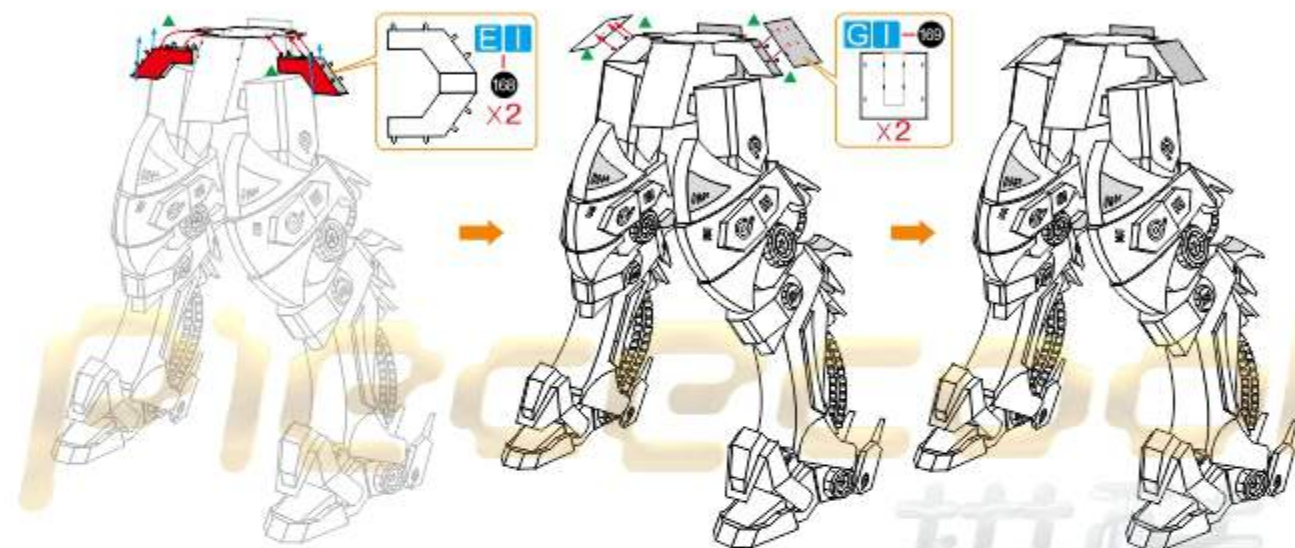

Step.8  
03

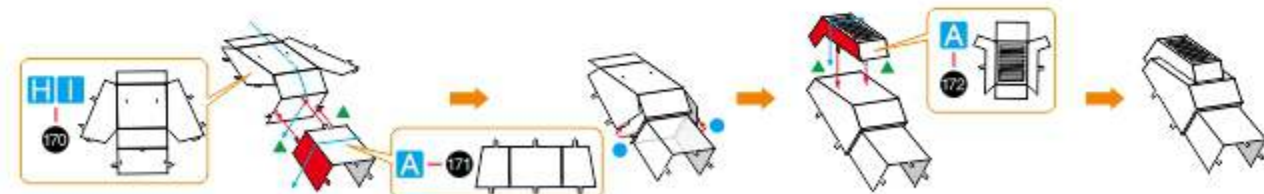

Step.8  
拼装步骤

Step.8  
拼装步骤

Step.8  
04

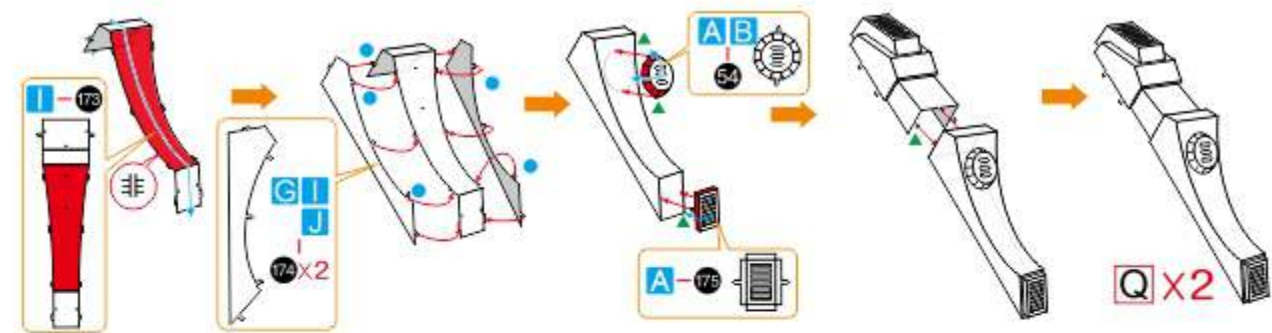

Step.8  
05

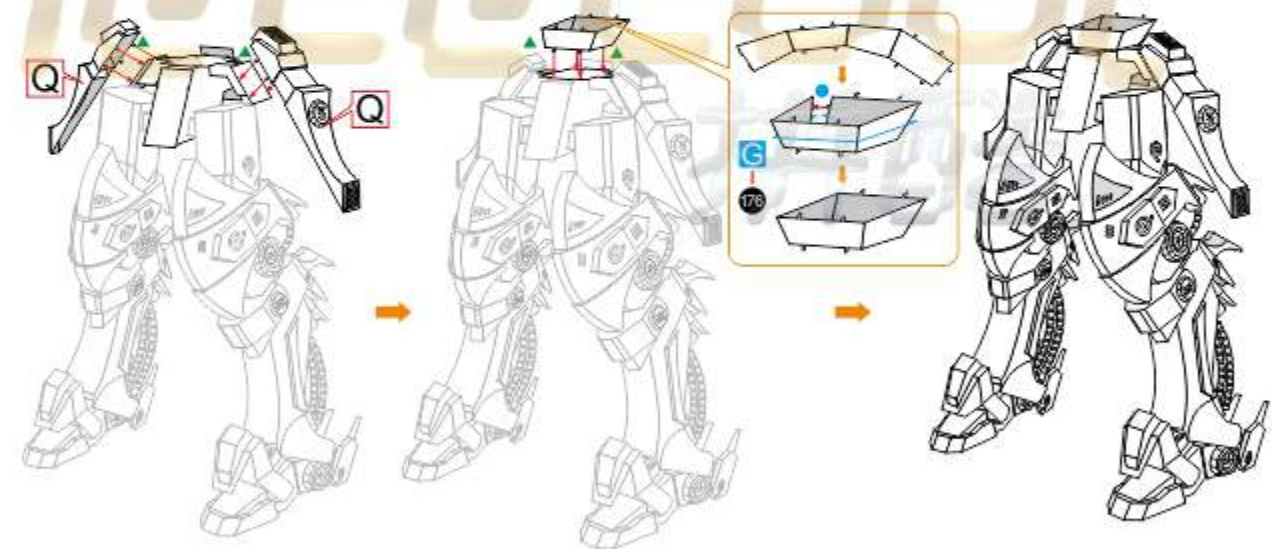

## Step.9 前面装备拼装

- 第01小步：零件编号J177,C178
- 第02小步：零件编号E179,C180
- 第03小步：零件编号H181,C182
- 第04小步：零件编号F183,A184
- 第05小步：零件编号E185,C186,B187
- 第06小步：零件编号H188,A189,A190
- 第07小步：零件编号C191,H192,G193
- 第08小步：零件编号H194

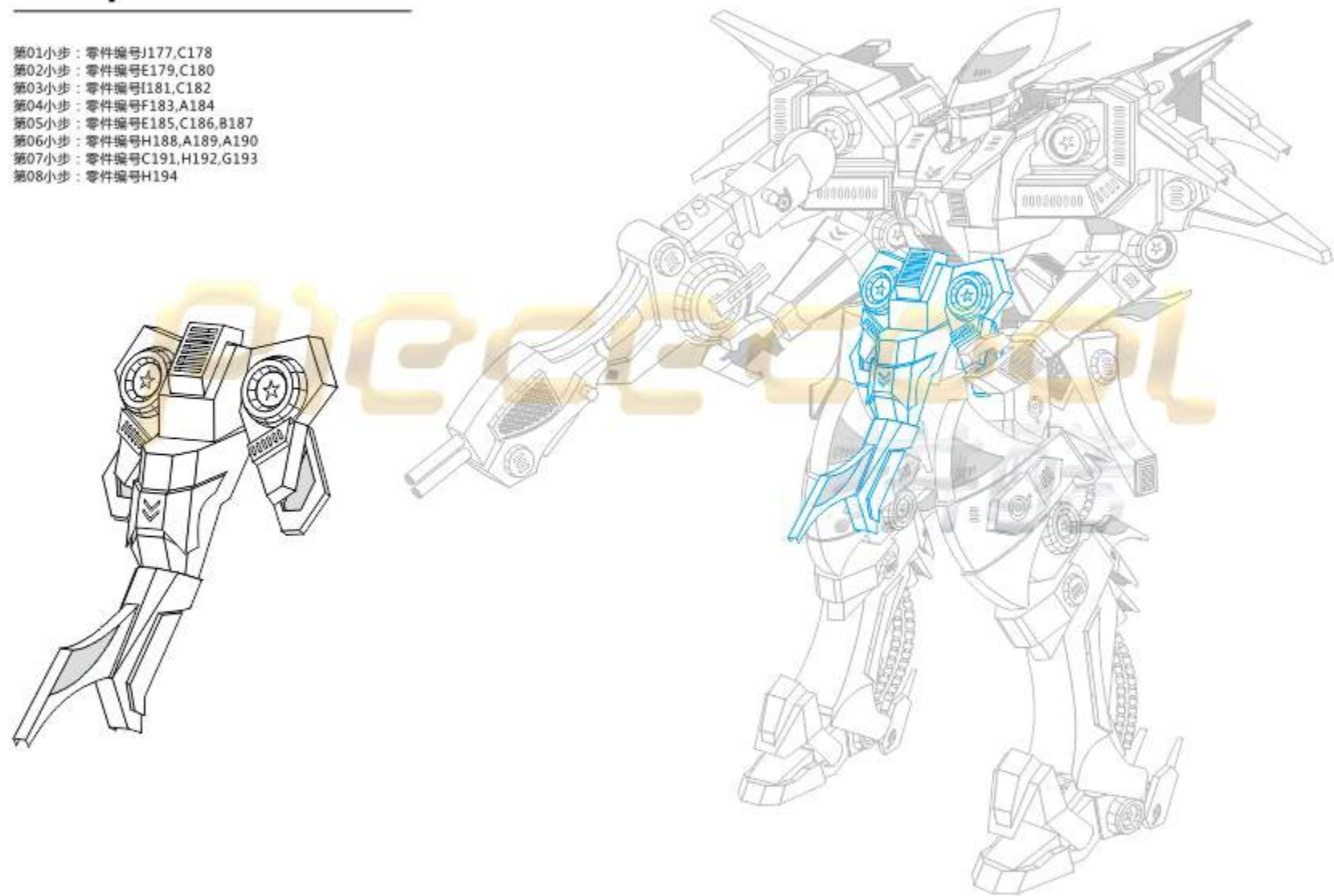

Step.9  
01



Step.9  
02

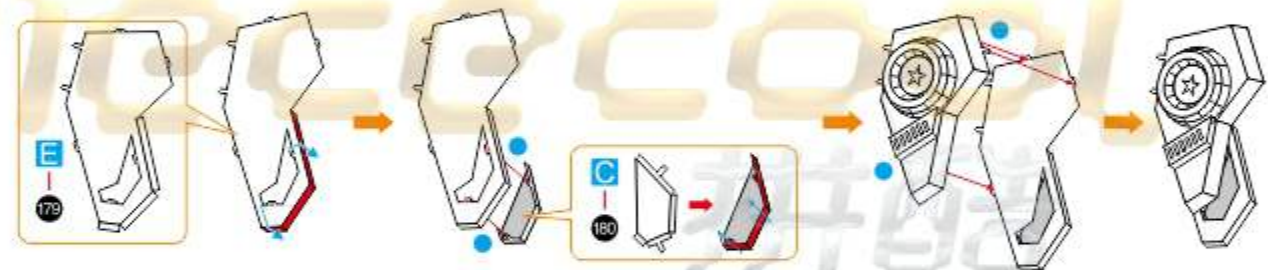

Step.9  
03

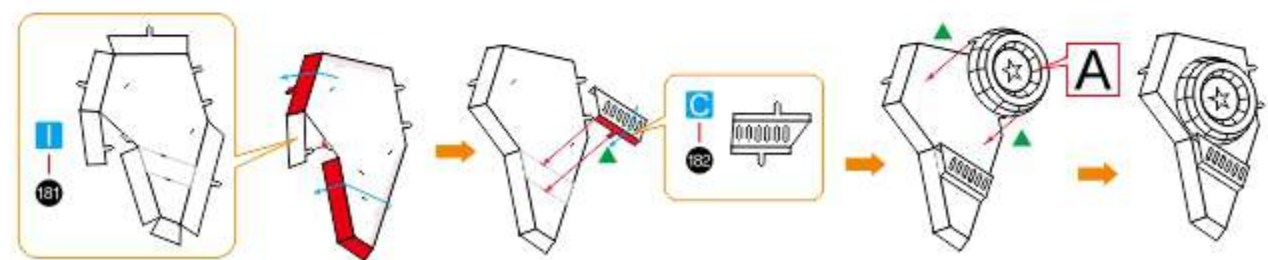

Step.9  
04

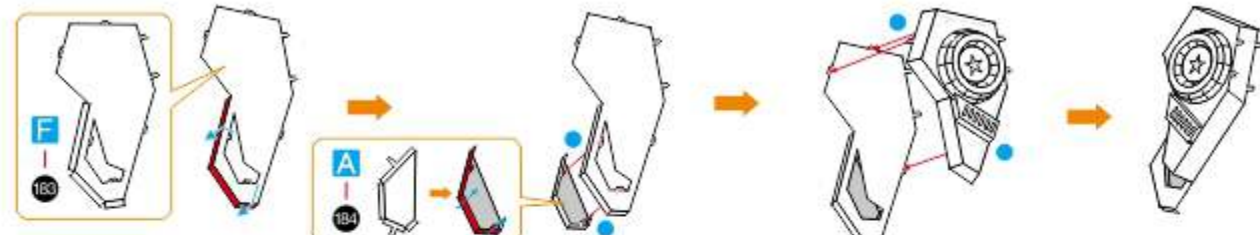

Step.9  
05

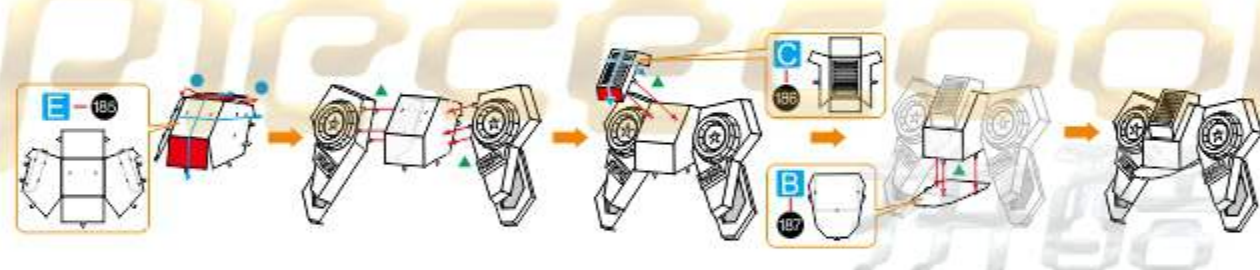

Step.9  
06

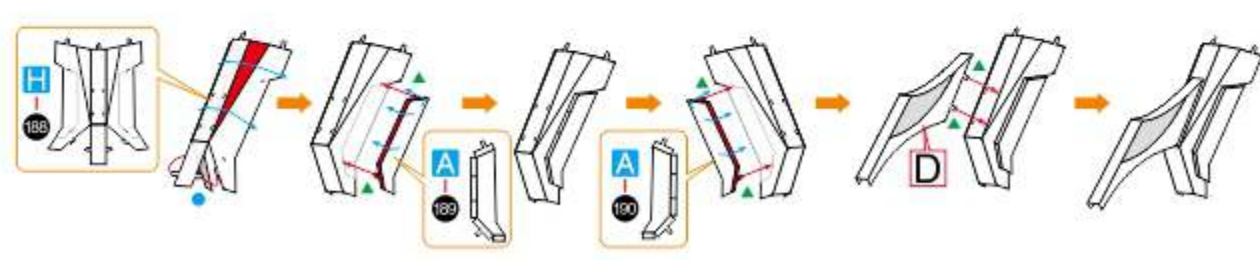

Step.9  
07

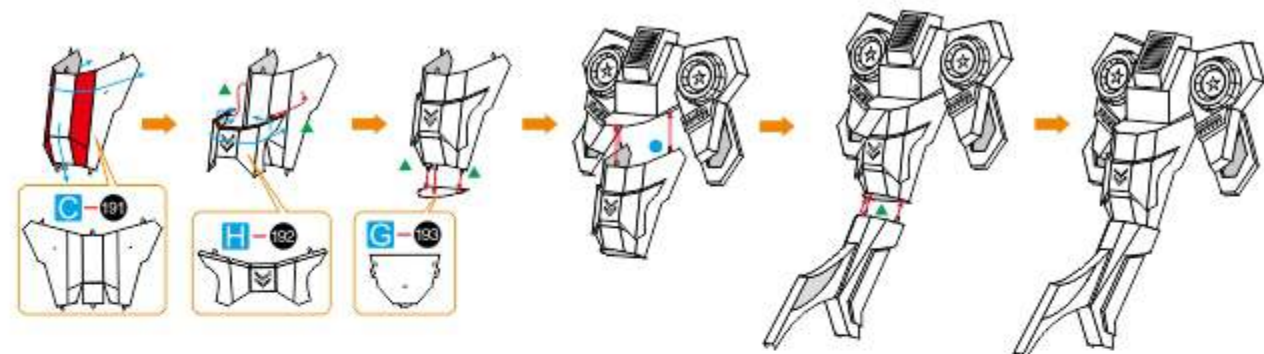

Step.9  
08

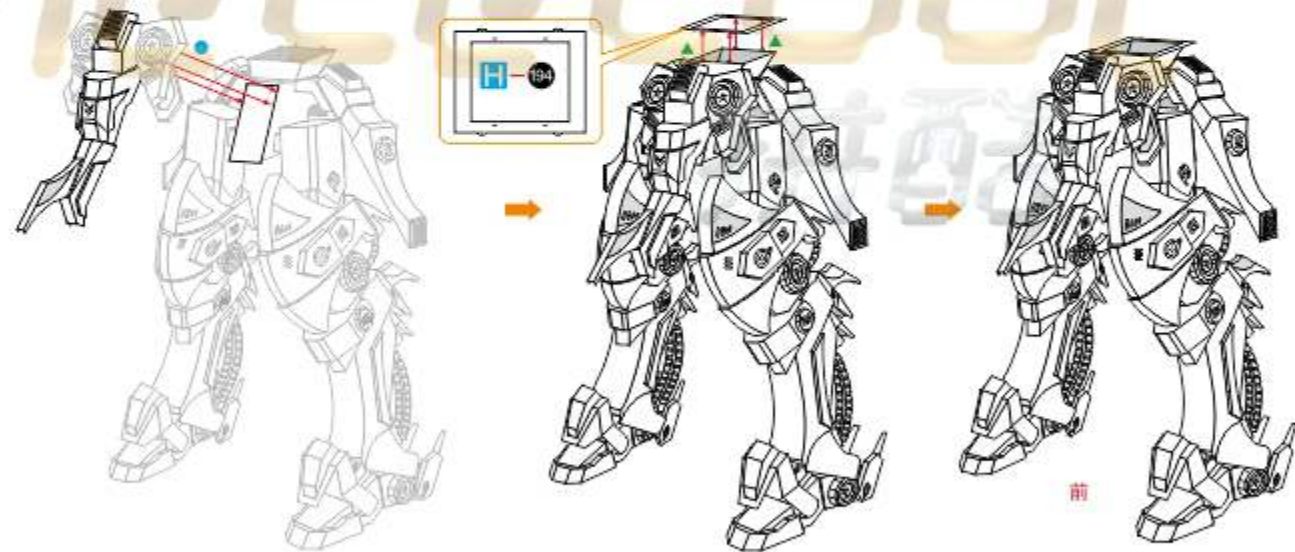

## Step.10 后面装备拼装

- 第01小步：零件编号I195,B196,J197,A198,A199
- 第02小步：零件编号H200,B201
- 第03小步：零件编号A202,C203,J204
- 第04小步：零件编号B202,B205,E206
- 第05小步：零件编号C207,C175
- 第06小步：零件编号E208

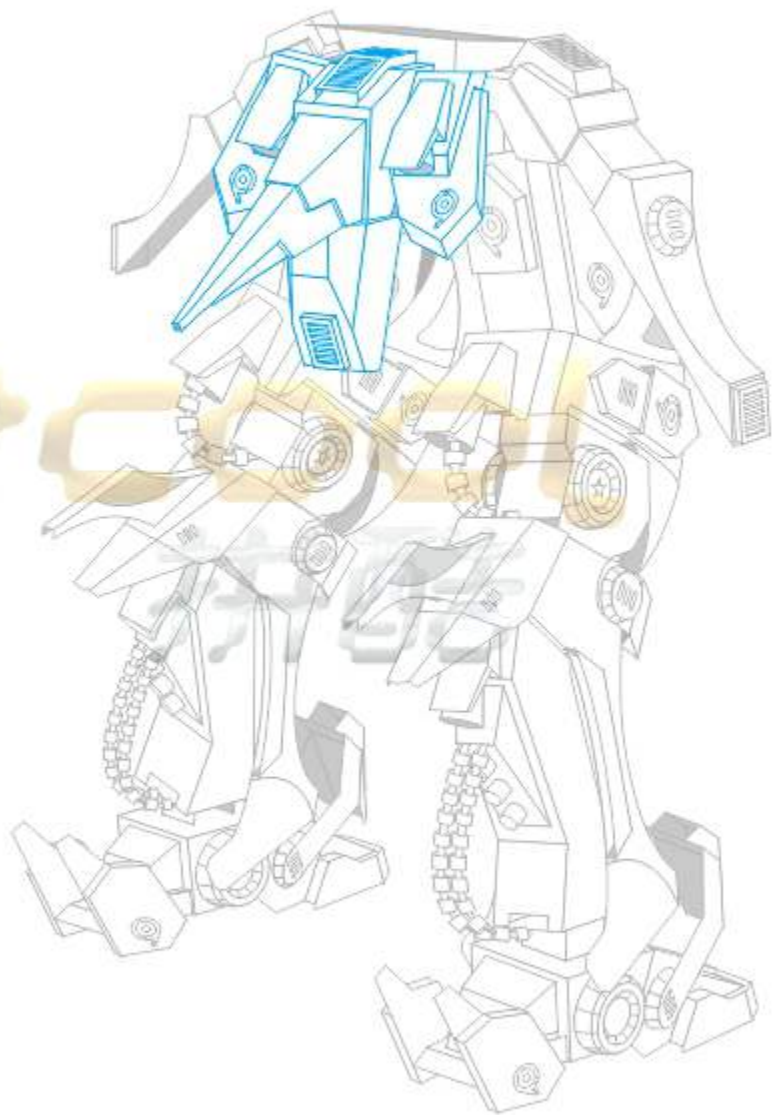
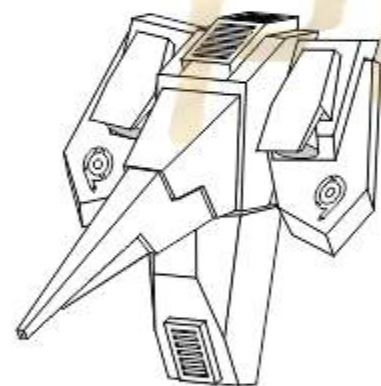

Step.10  
01

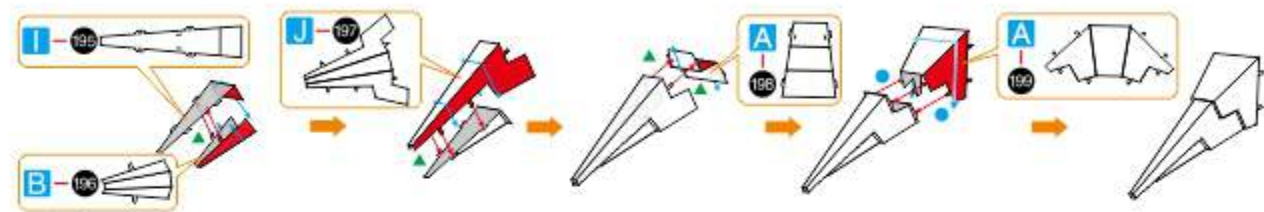

Step.10  
02

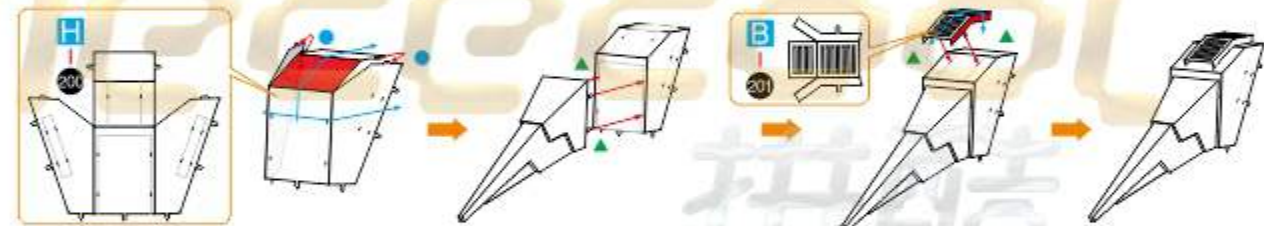

Step.10  
03

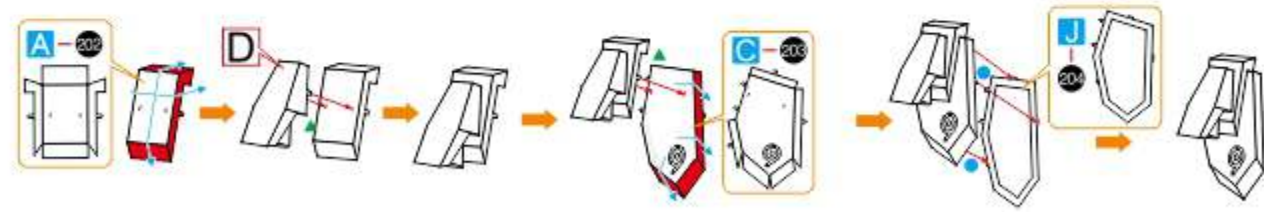

Step.10  
04

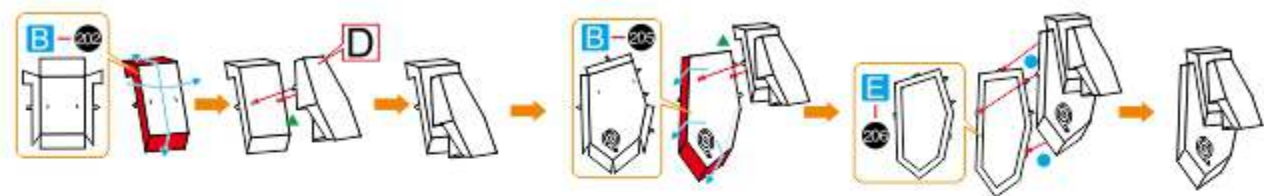

Step.10  
05



Step.10  
06

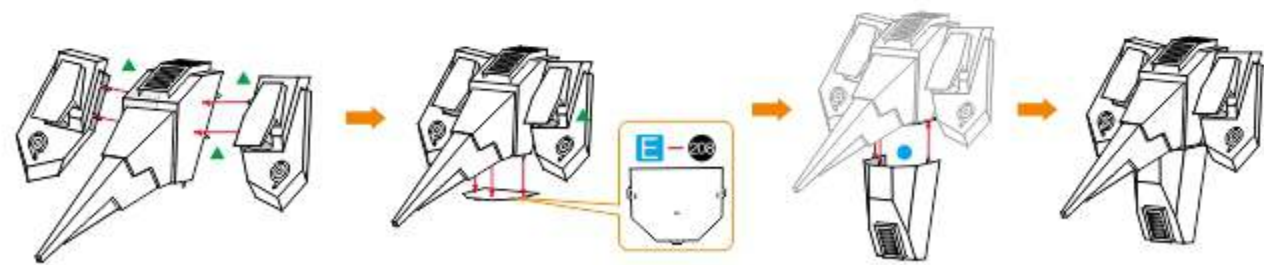



Step.10  
07

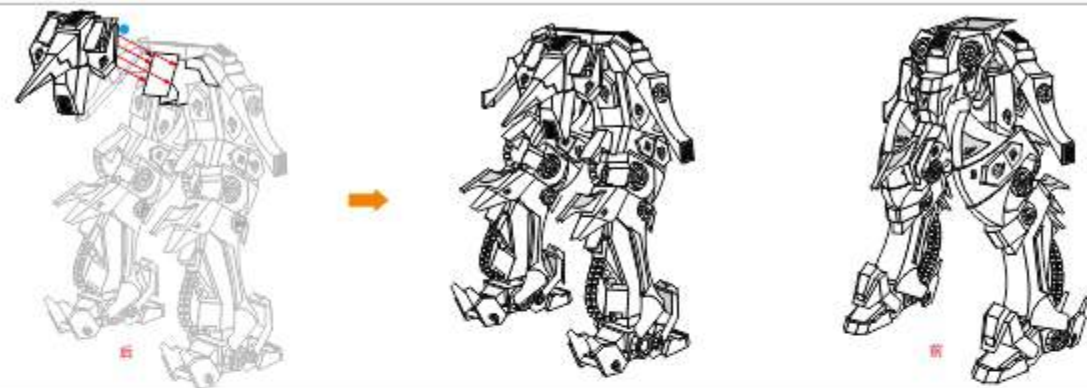

Step.10  
08

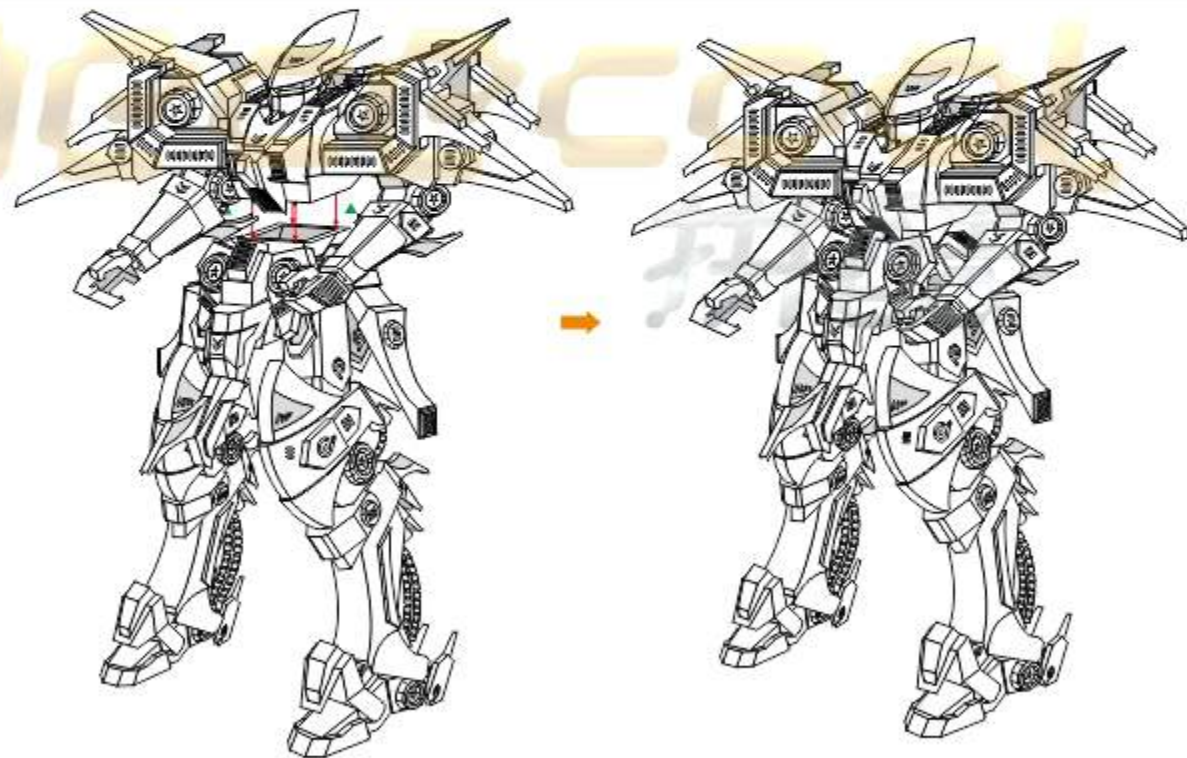

## Step.11 武器装备拼装

- 第01小步：零件编号G209,I210
- 第02小步：零件编号E211,B212
- 第03小步：零件编号C213,B61
- 第04小步：零件编号C214,B61,G215,C61
- 第05小步：零件编号B216,A217,A218
- 第06小步：零件编号E219,E220,L220
- 第07小步：零件编号A222,A223,H221
- 第08小步：零件编号A224,B225
- 第09小步：零件编号F226,J227,F228,K229,K230
- 第10小步：零件编号K231,B54,C61,C232
- 第11小步：零件编号E233,B234,E235,J235
- 第12小步：零件编号B54,B236,F237,C238
- 第13小步：零件编号C239,G240,C241,C242,A243
- 第14小步：零件编号B244,B54,G237

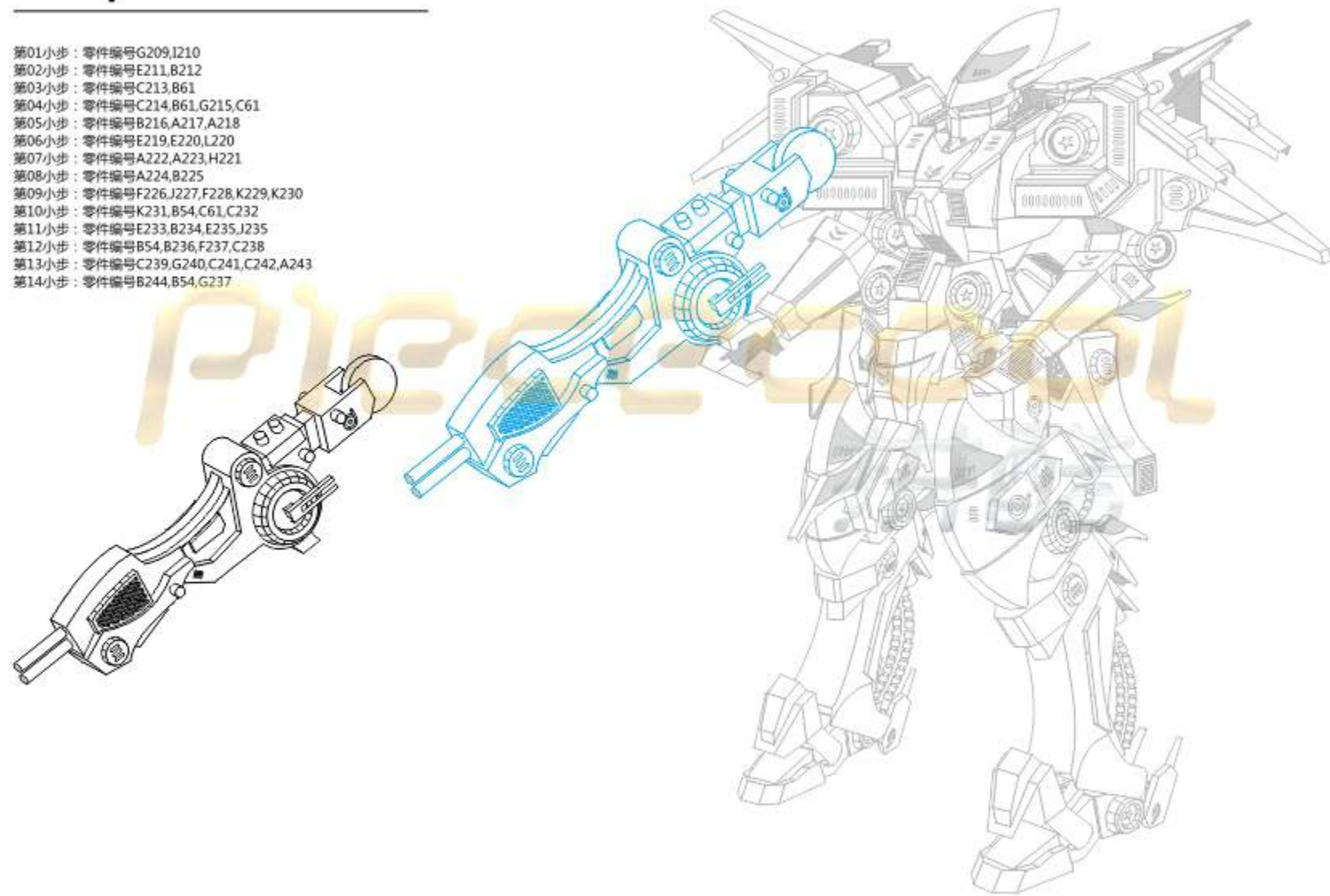

Step.11  
01

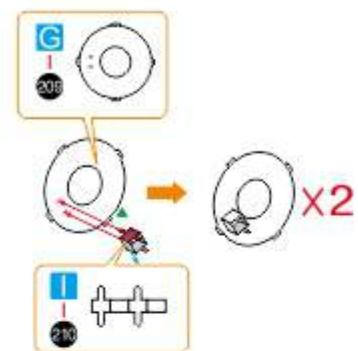

Step.11  
02

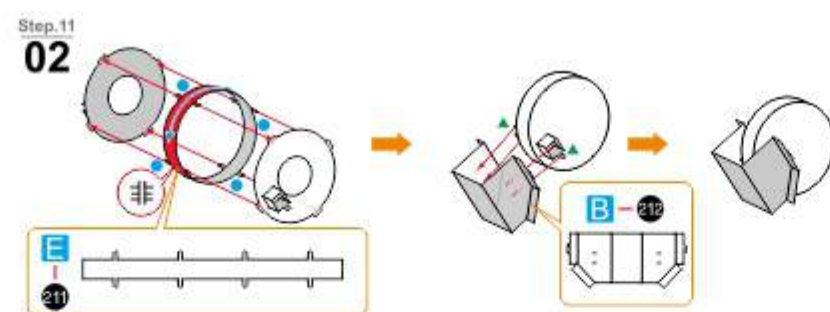

Step.11  
03

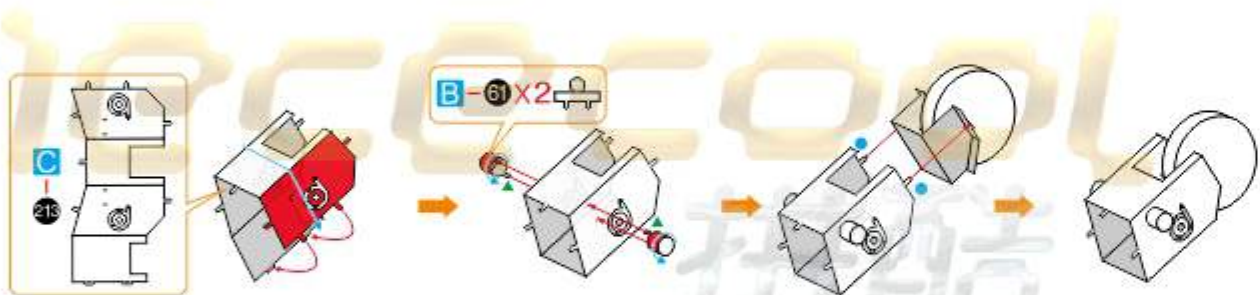

Step.11  
04

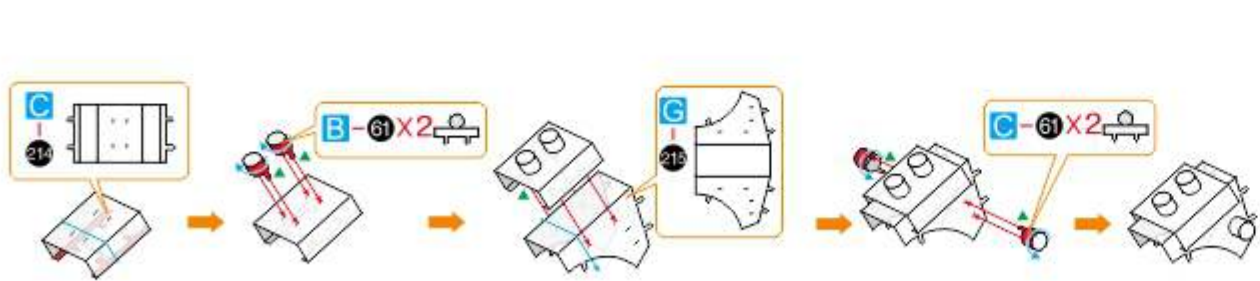

Step.11  
05

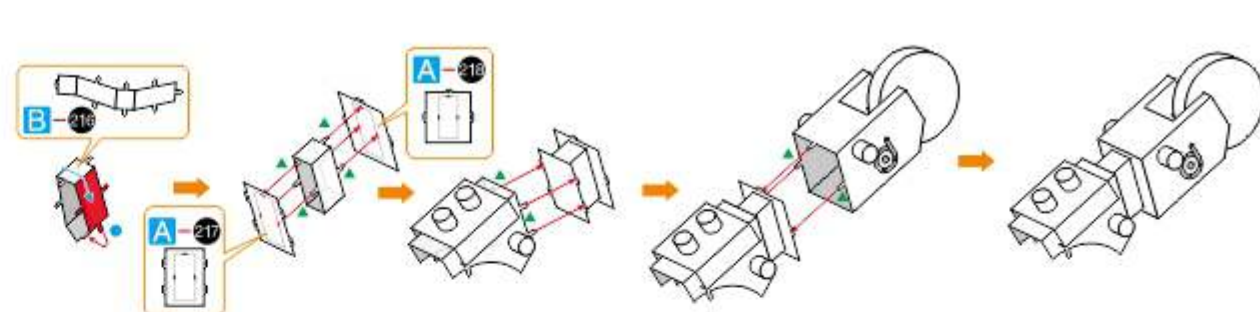

Step.11  
06

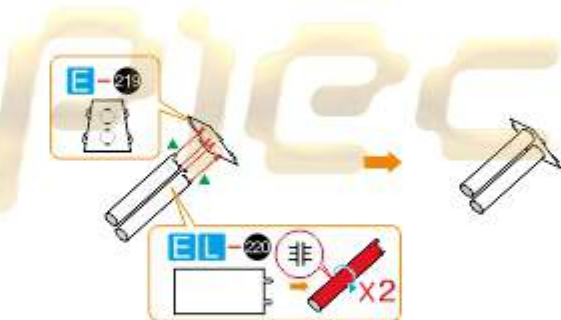

Step.11  
07



Step.11  
08

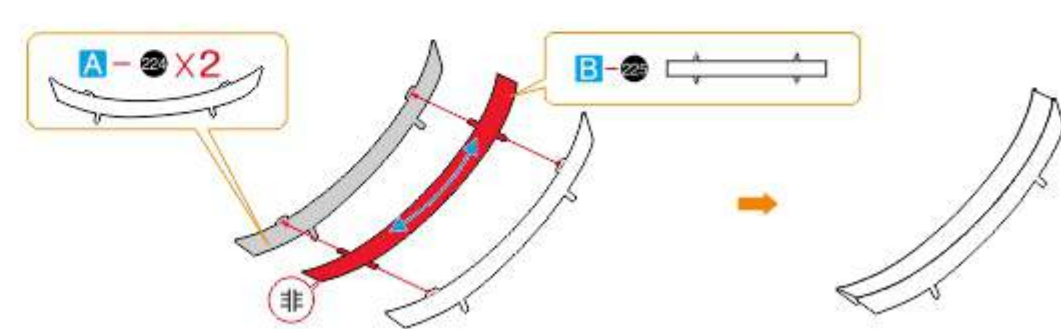

Step.11  
09

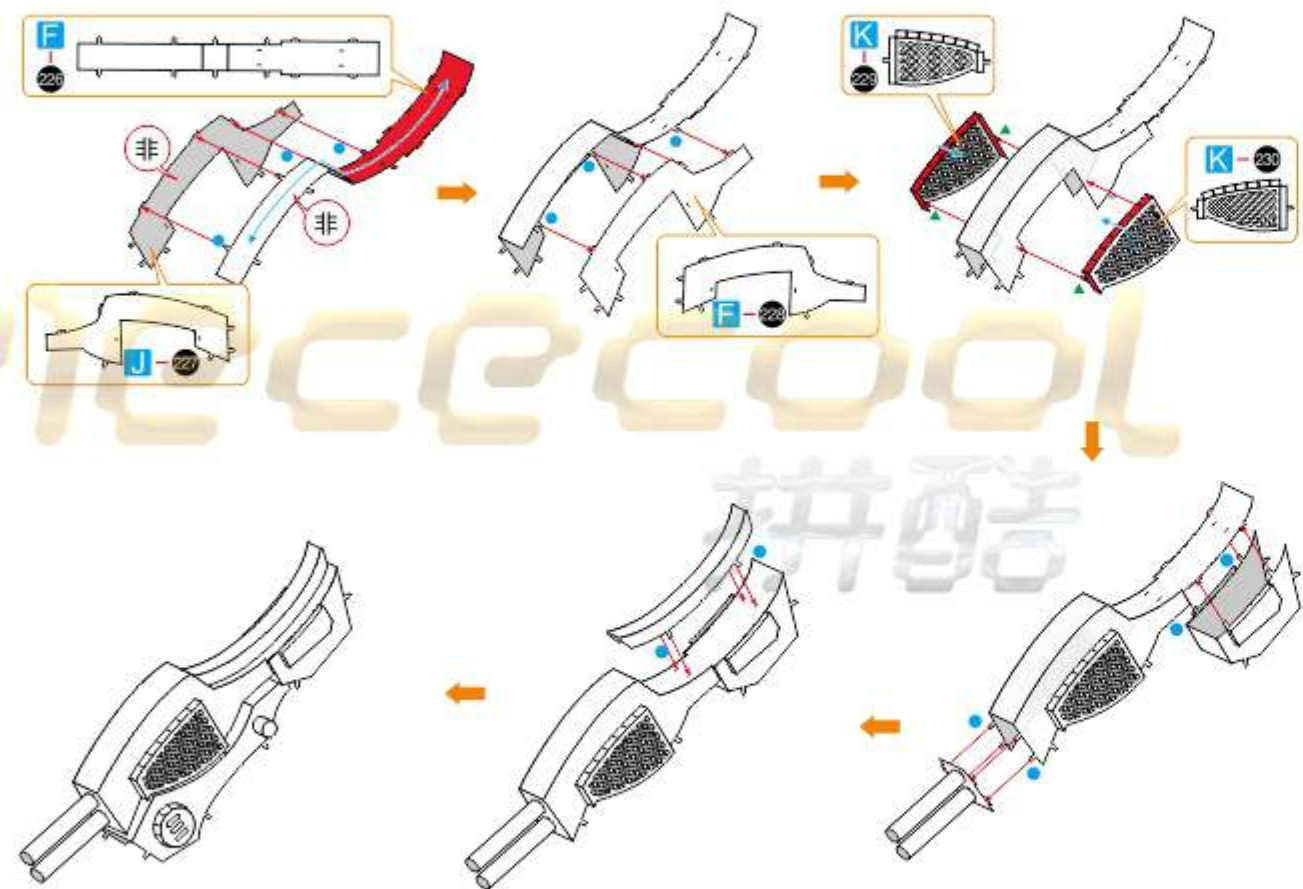

Step.11  
10

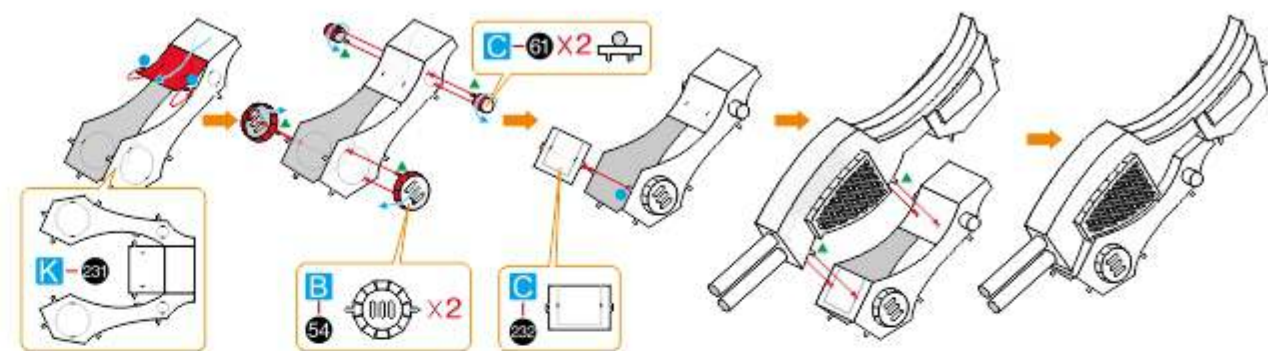

Step.11  
11



Step.11  
12

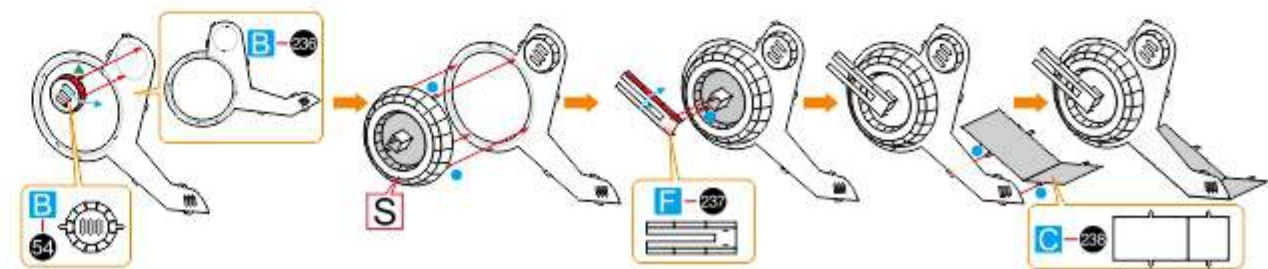

Step.11  
武器装备拼装

Step.11  
武器装备拼装

Step.11  
13

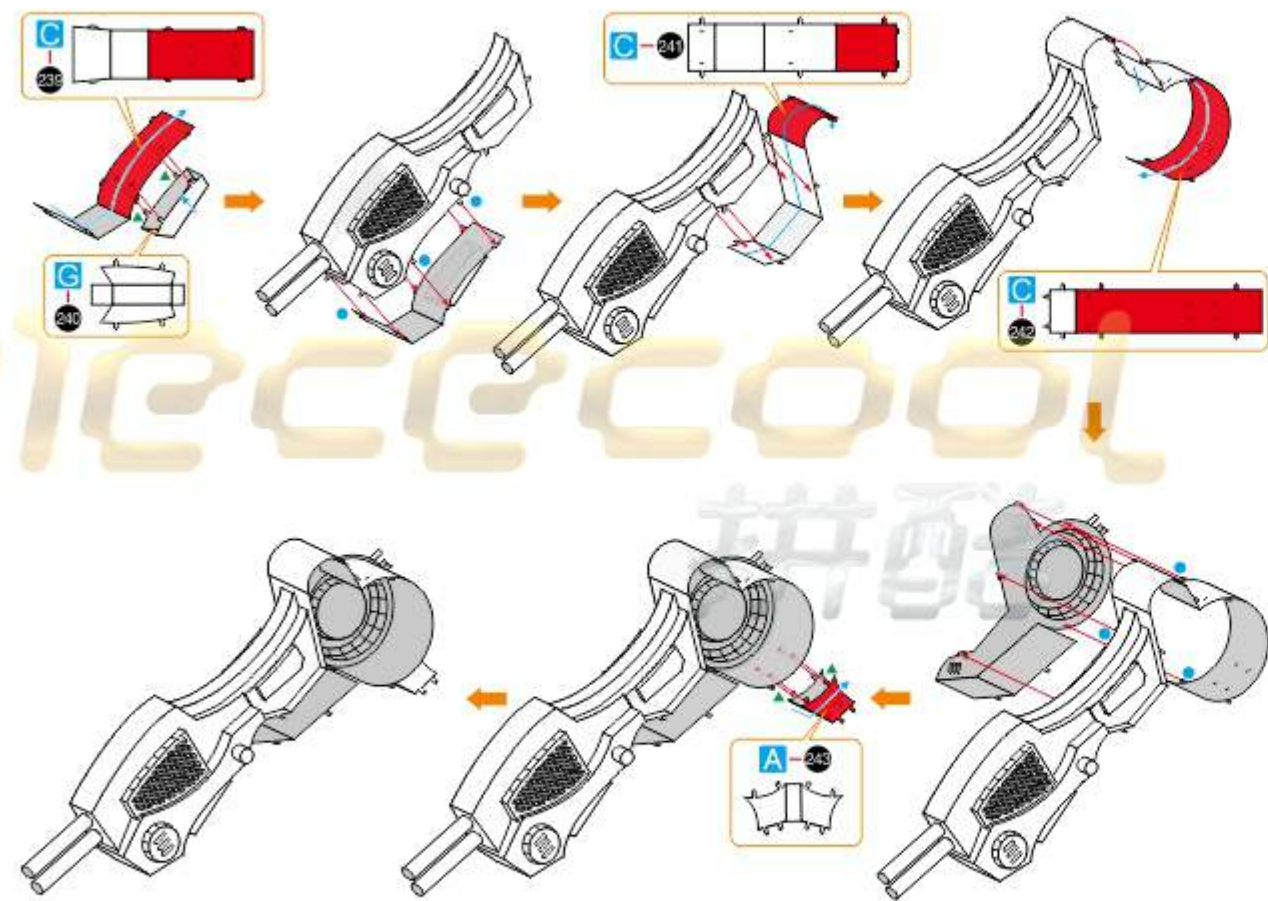

Step.11  
14

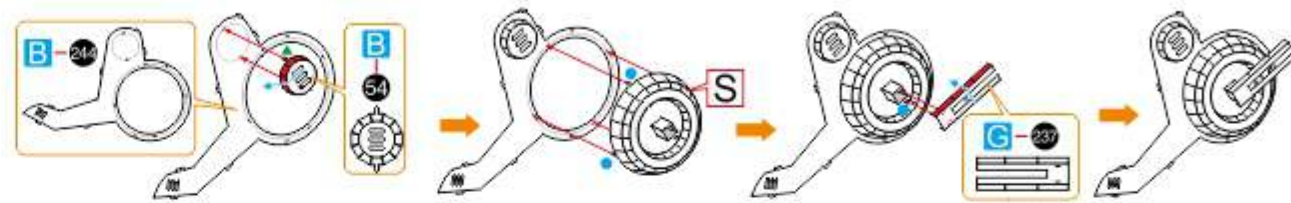

Step.11  
15

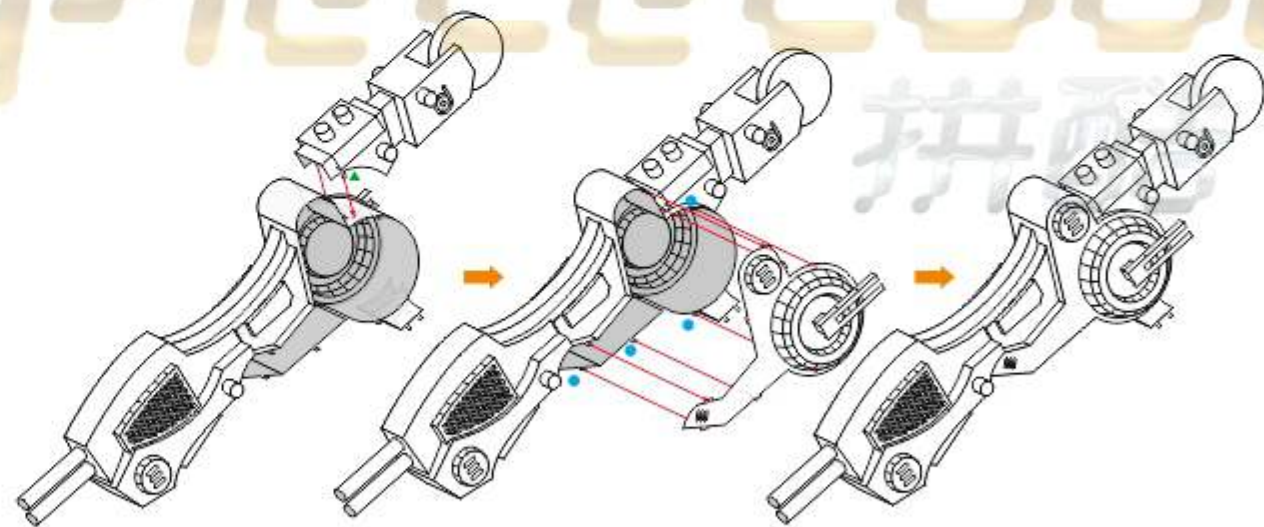

Step.11  
拼装准备拼装

Step.11  
拼装准备拼装

Step.11  
16

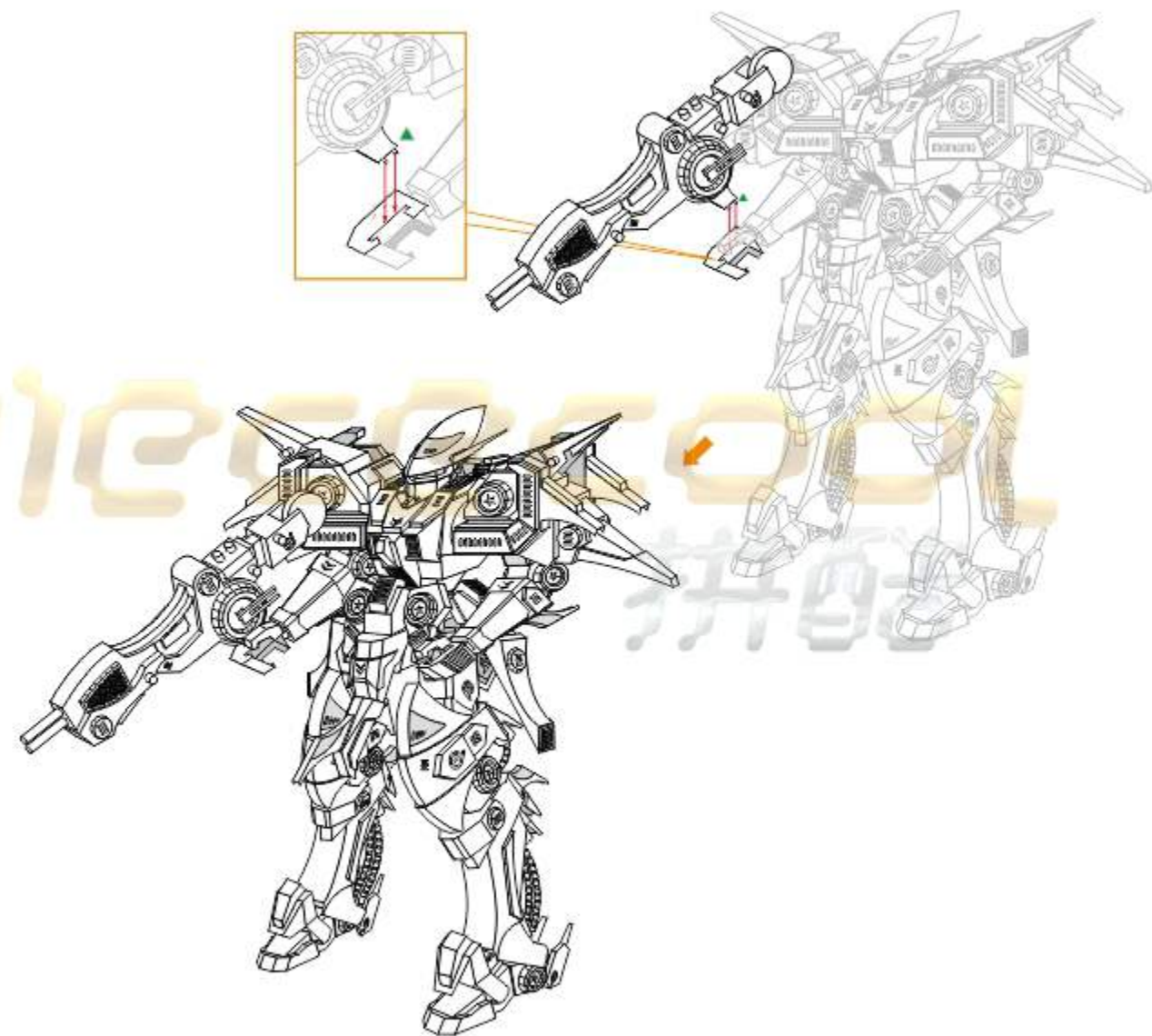

Piececool  
拼酷

Piececool  
拼酷

更多详情信息请登录：<http://www.piececool.com>

Step.11  
拼装指南

东莞市微石塑胶金属科技有限公司 出品  
WIST PLASTIC & METAL TECHNOLOGY LIMITED  
地址：广东省东莞市寮步镇向西工业区村口街2号 邮编：523408  
电子邮箱：kf@wist-group.com  
服务热线：0769-8119 2243

© Wist Plastic & Metal Technology Limited. All rights reserved.

P095.SMS.20171001.A1