

R2D2 IP031

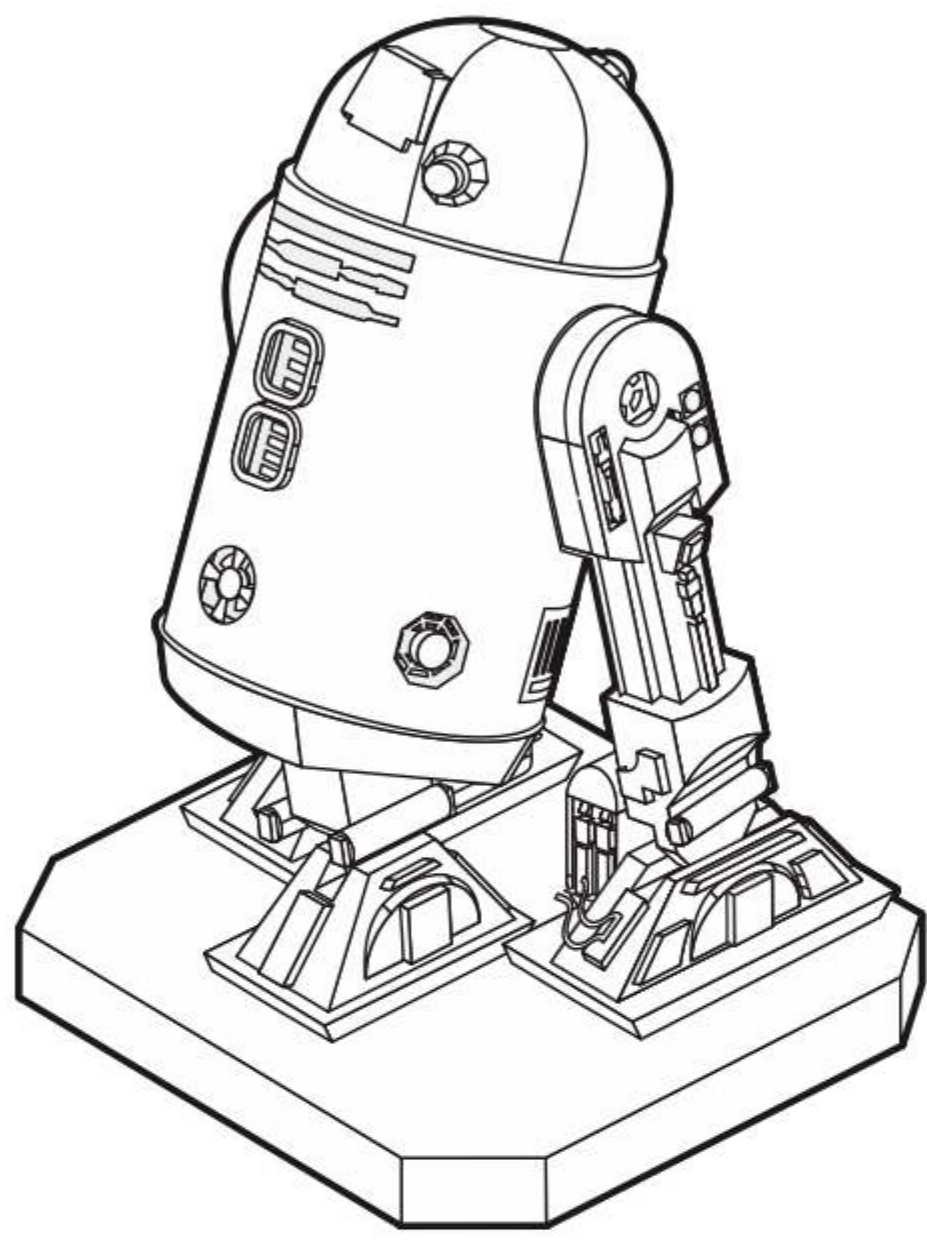

CP-ASSY-IP031-A1-20200326

拼前需知

• 准备工具:

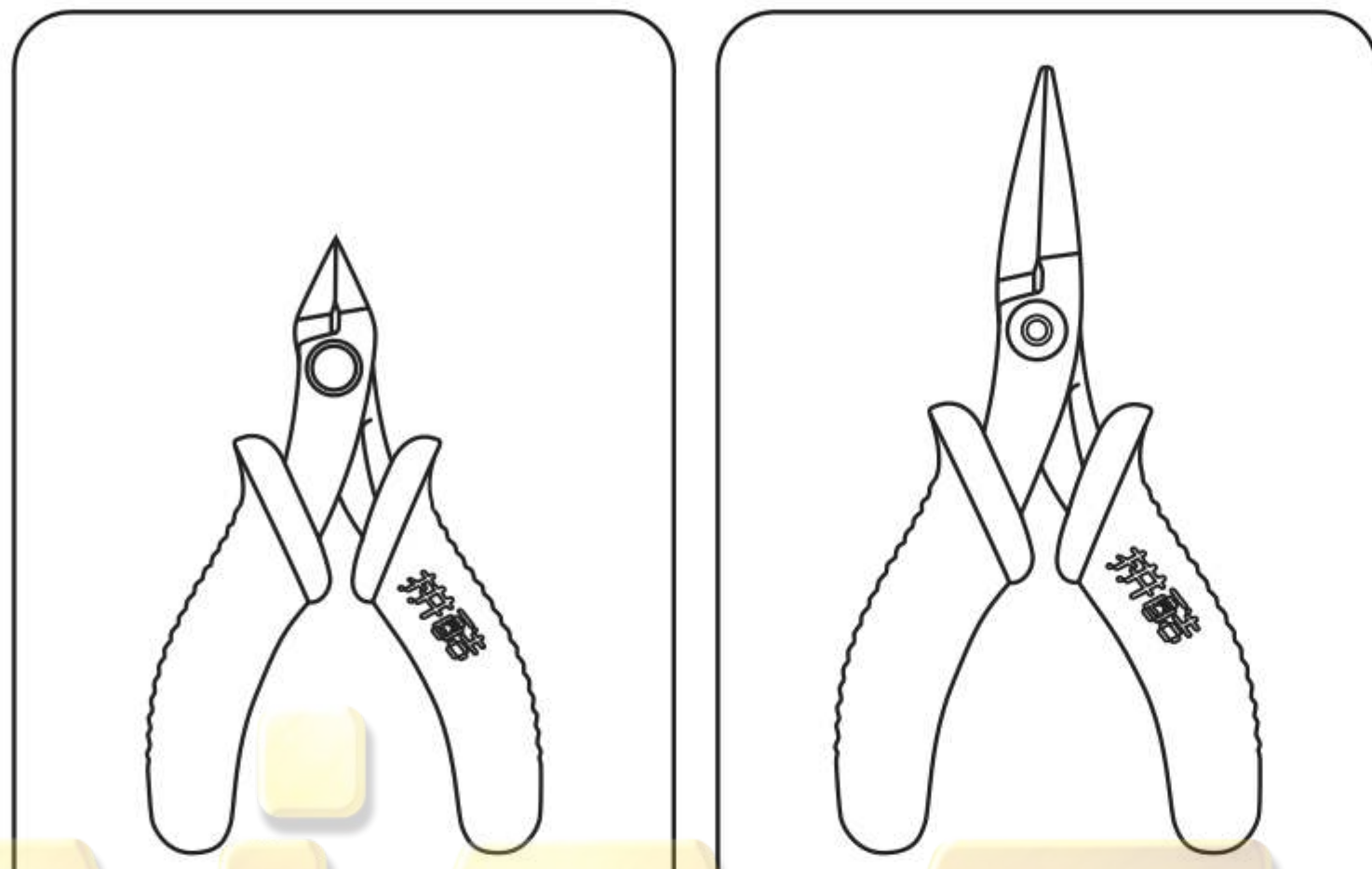

水口钳工具

修剪金属片板件上的零件水口位。

尖嘴钳工具

弯折金属零件上的折叠线和扣点。

建议使用拼酷正品拼装工具（水口钳、尖嘴钳），拼装时更省心、省力，拼装后作品更精细、美观！

⚠️ 请小心处理金属边料，以防划伤

• 拼装方法:

a. 取下零件



使用水口钳剪断金属零件上的水口，将需要的金属零件从金属片板上取下。

b. 识别零件

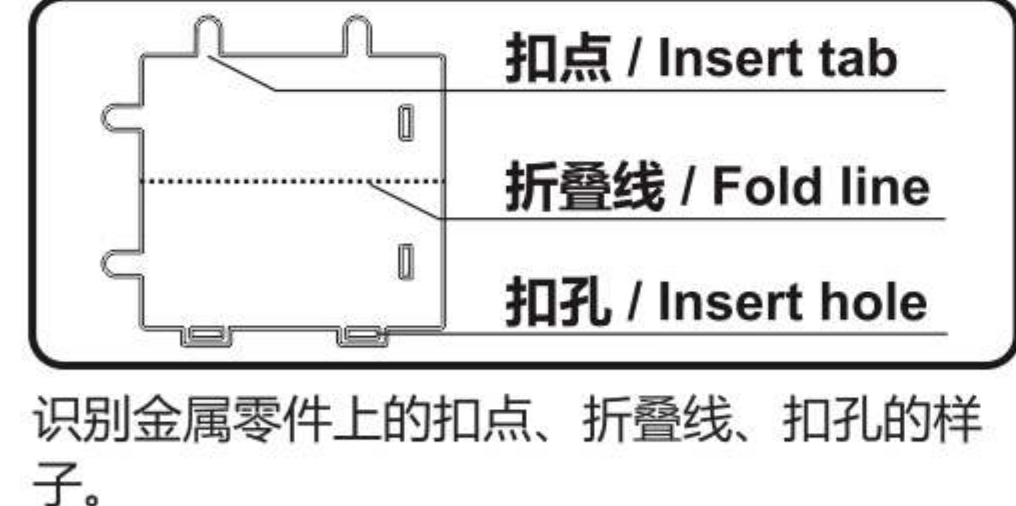

识别金属零件上的扣点、折叠线、扣孔的样子。

c. 折叠零件

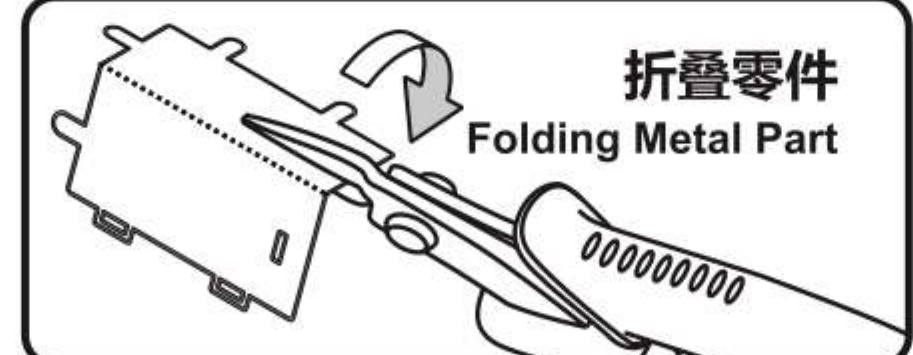

使用尖嘴钳，参照拼装说明书将金属零件折成形状。

d. 固定零件



● 插入扣孔，平折 90°



▲ 插入扣孔，旋转 90°

• 注意事项:



剪金属零件时请剪零件“水口位”，请勿将“扣点”当成“水口位”剪下，每次剪零件时请仅剪当前步骤的零件，切勿一次性将所有零件全部剪下，避免丢失；
当遇到折叠线的零件，请注意金属片的正反面及拼折方向，请按照说明书说明的方向，轻剪慢折，最好一次折叠完成，请勿反复折叠，避免零件损坏。

拼装步骤

Step 1

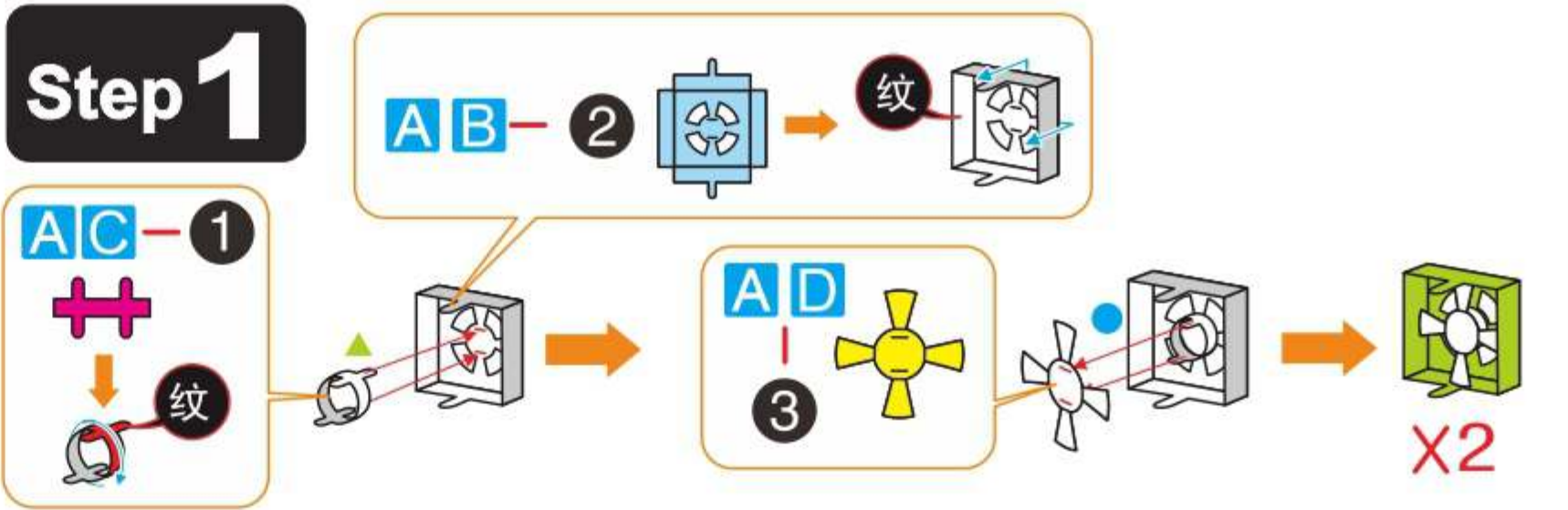

Step 2

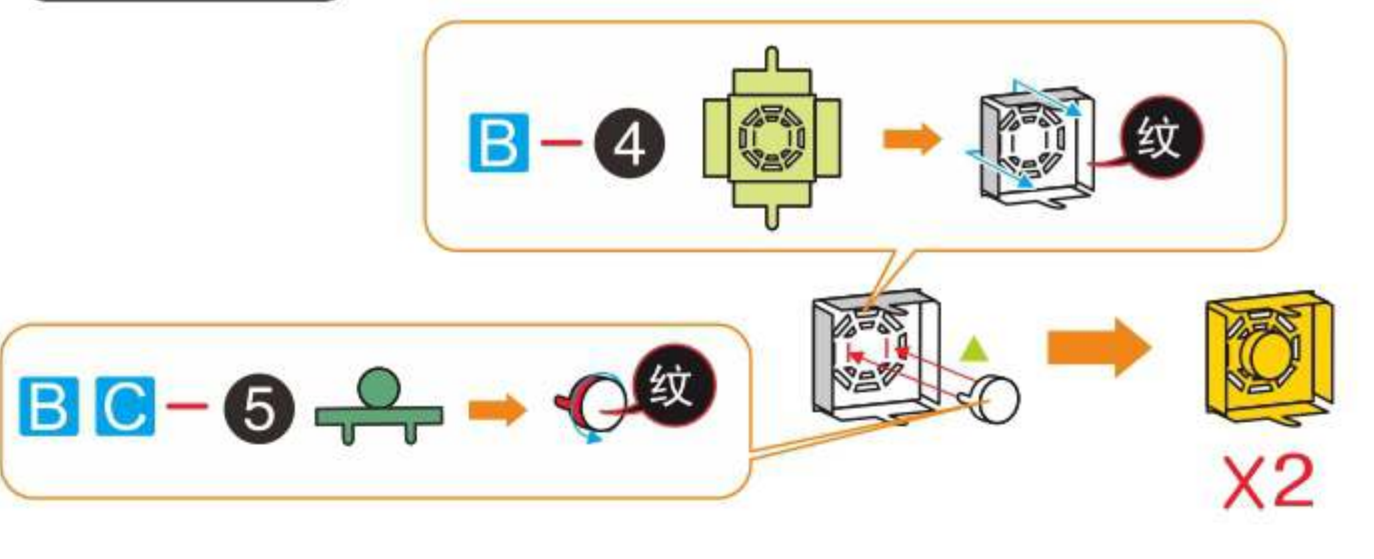

Step 3

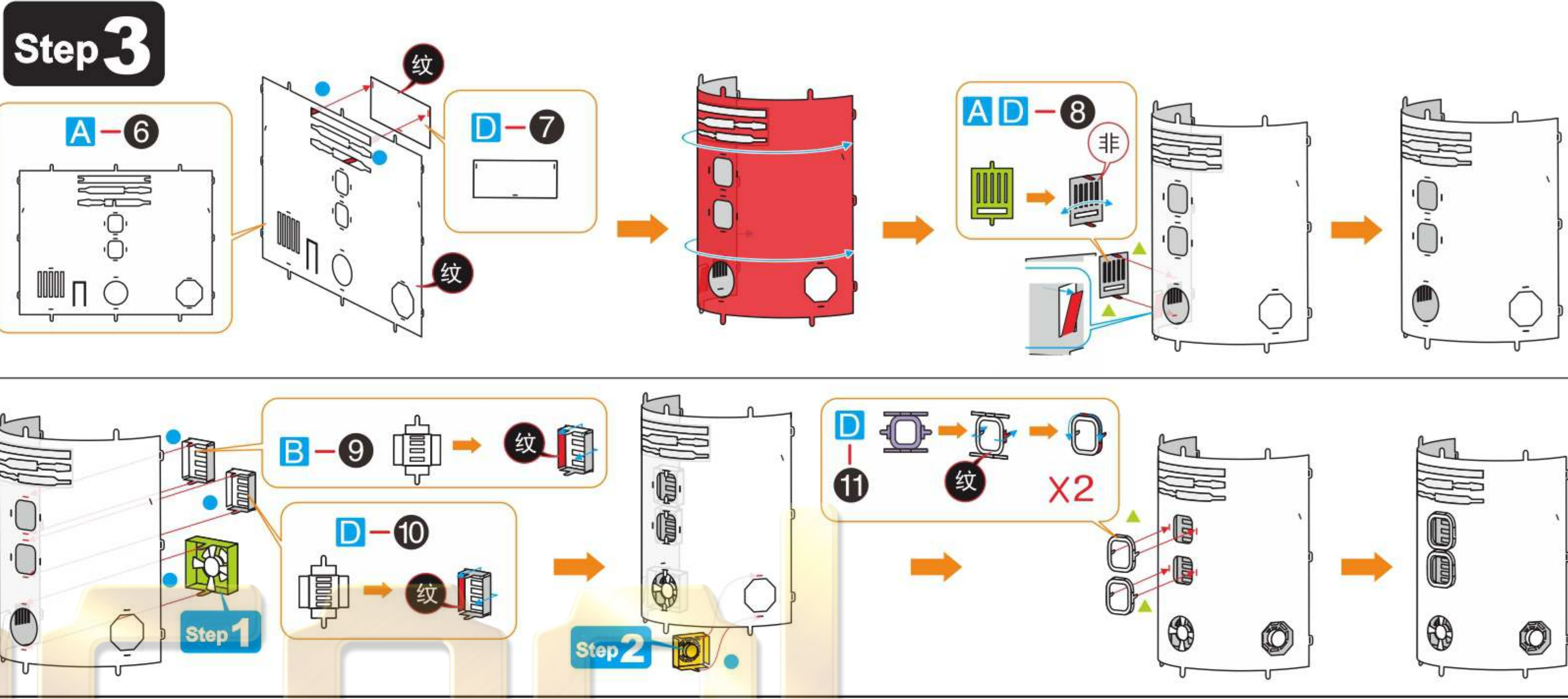

Step 4

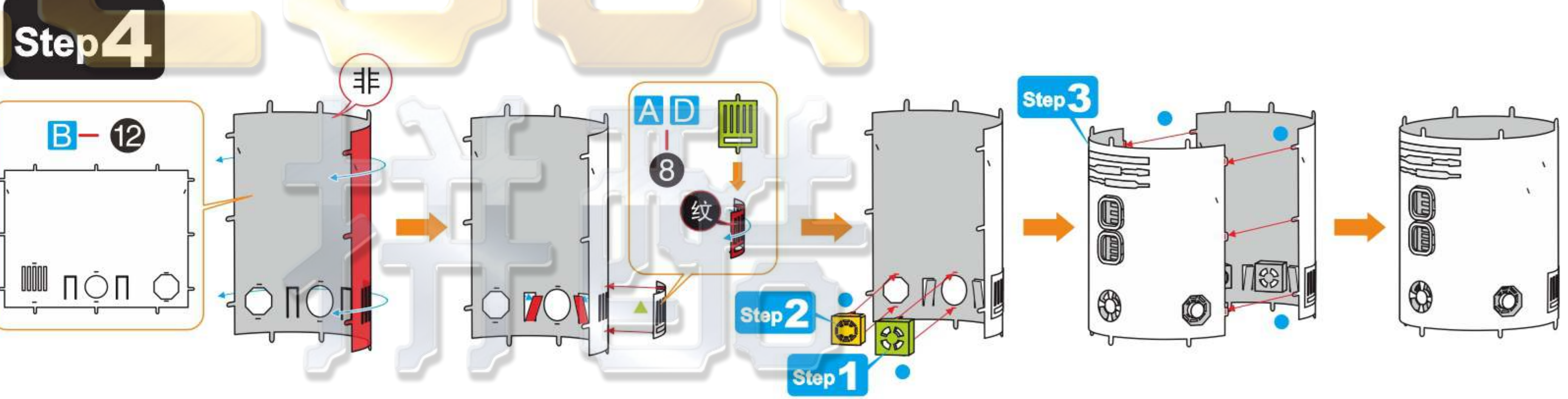

Step 5

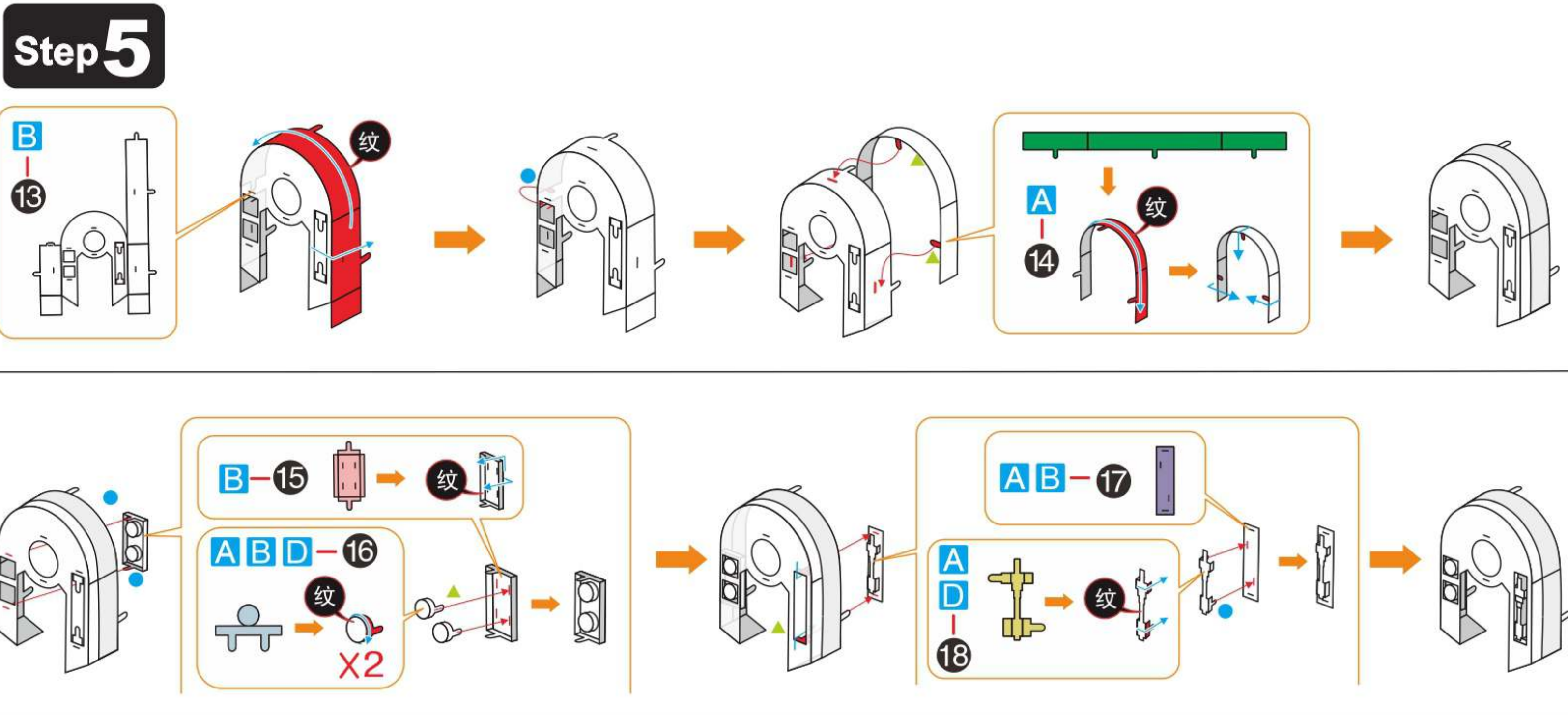

Step 10

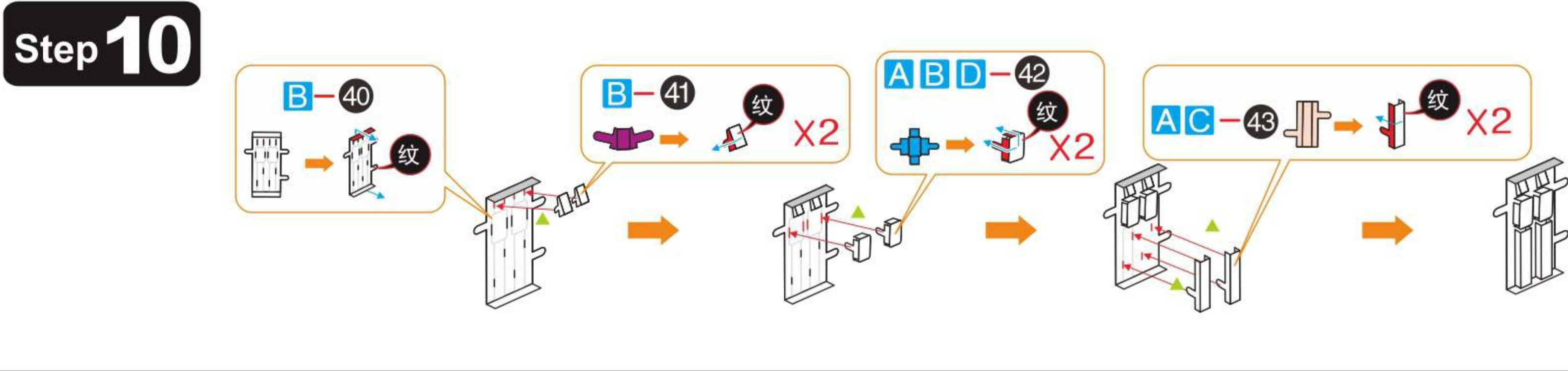

Step 11

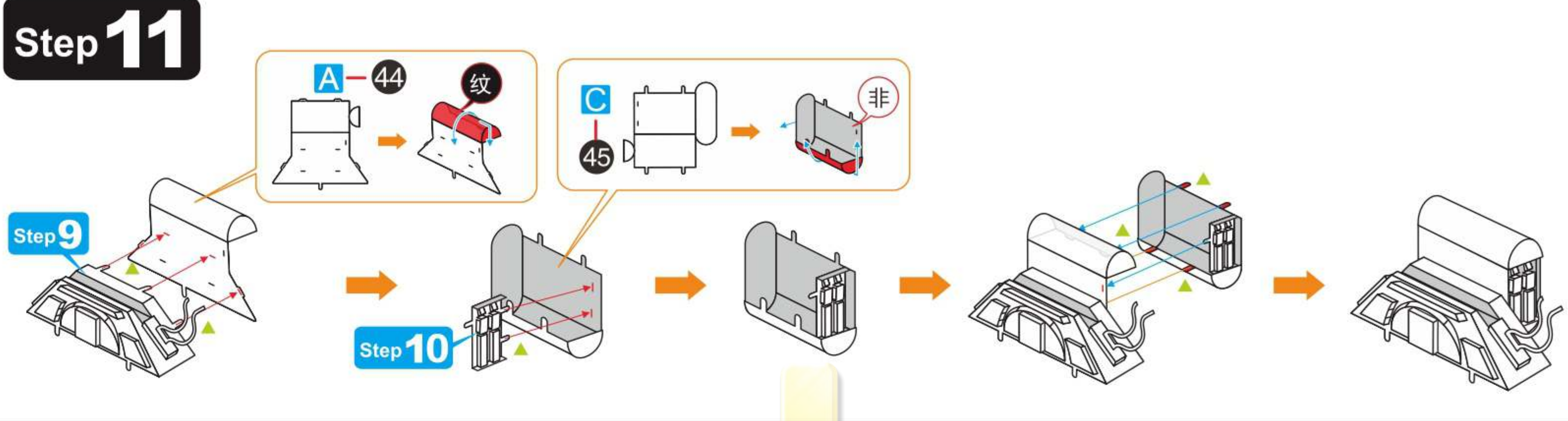

Step 12

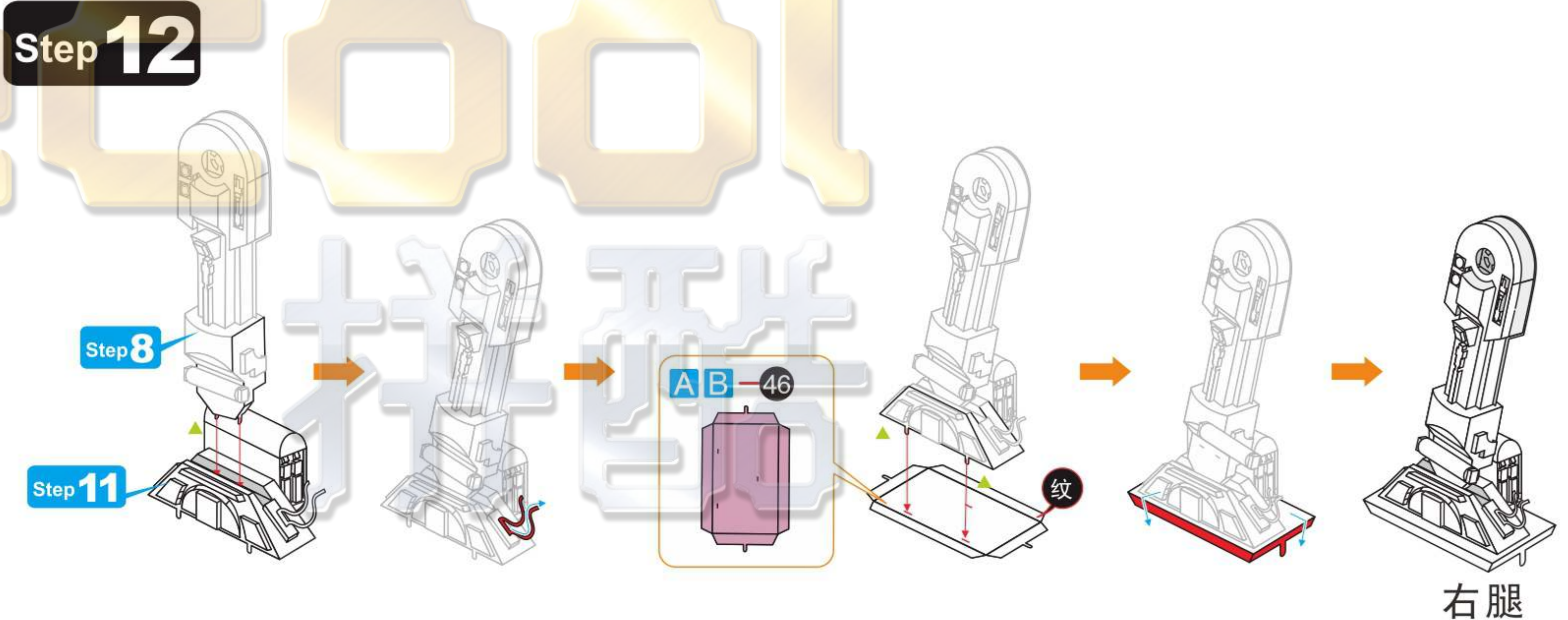

右腿

Step 13

