

## 钢铁侠 IRON MAN IP011

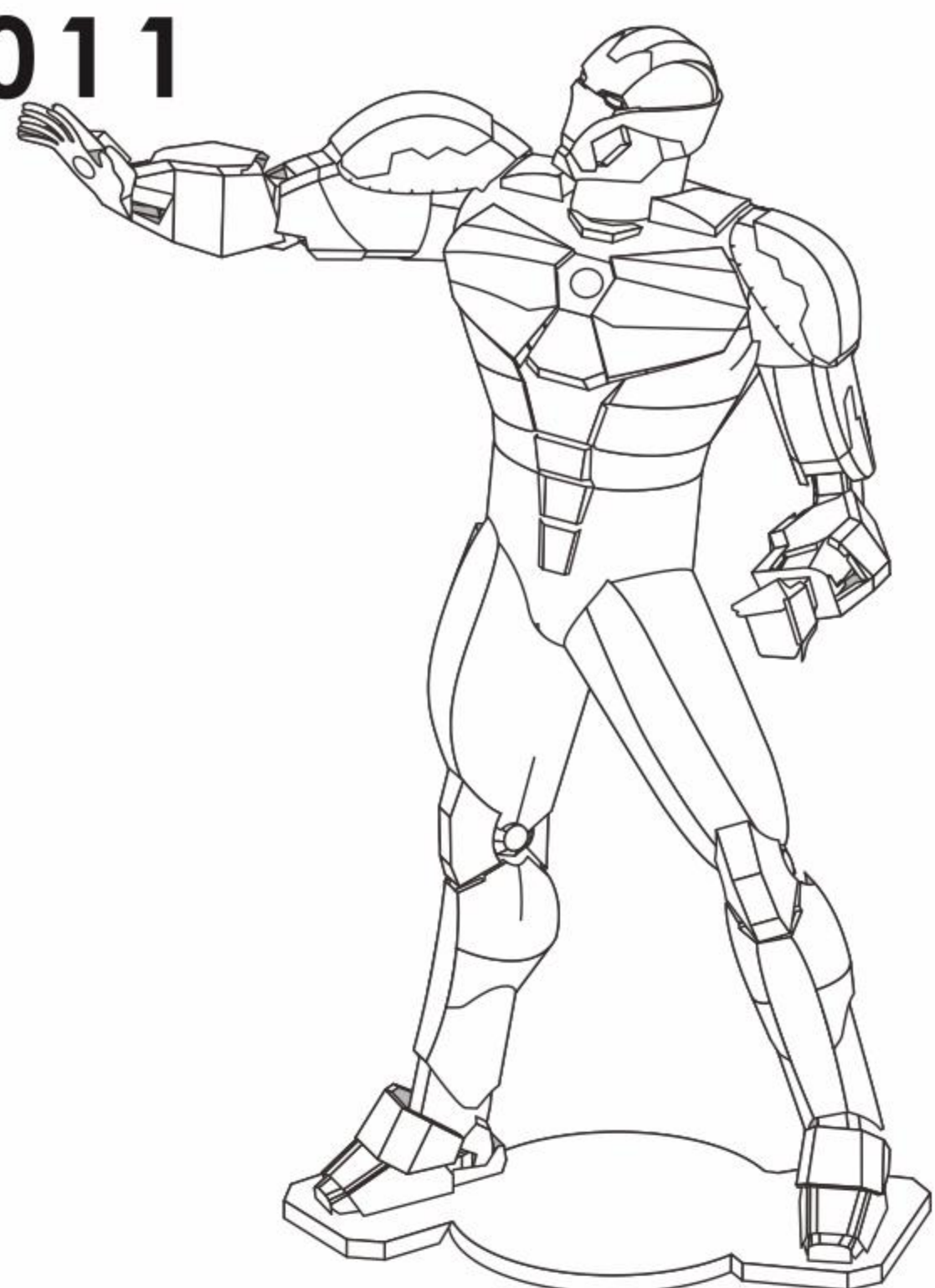

CP-ASSY-IP011-A1-20200908

### 拼前需知

#### • 准备工具:

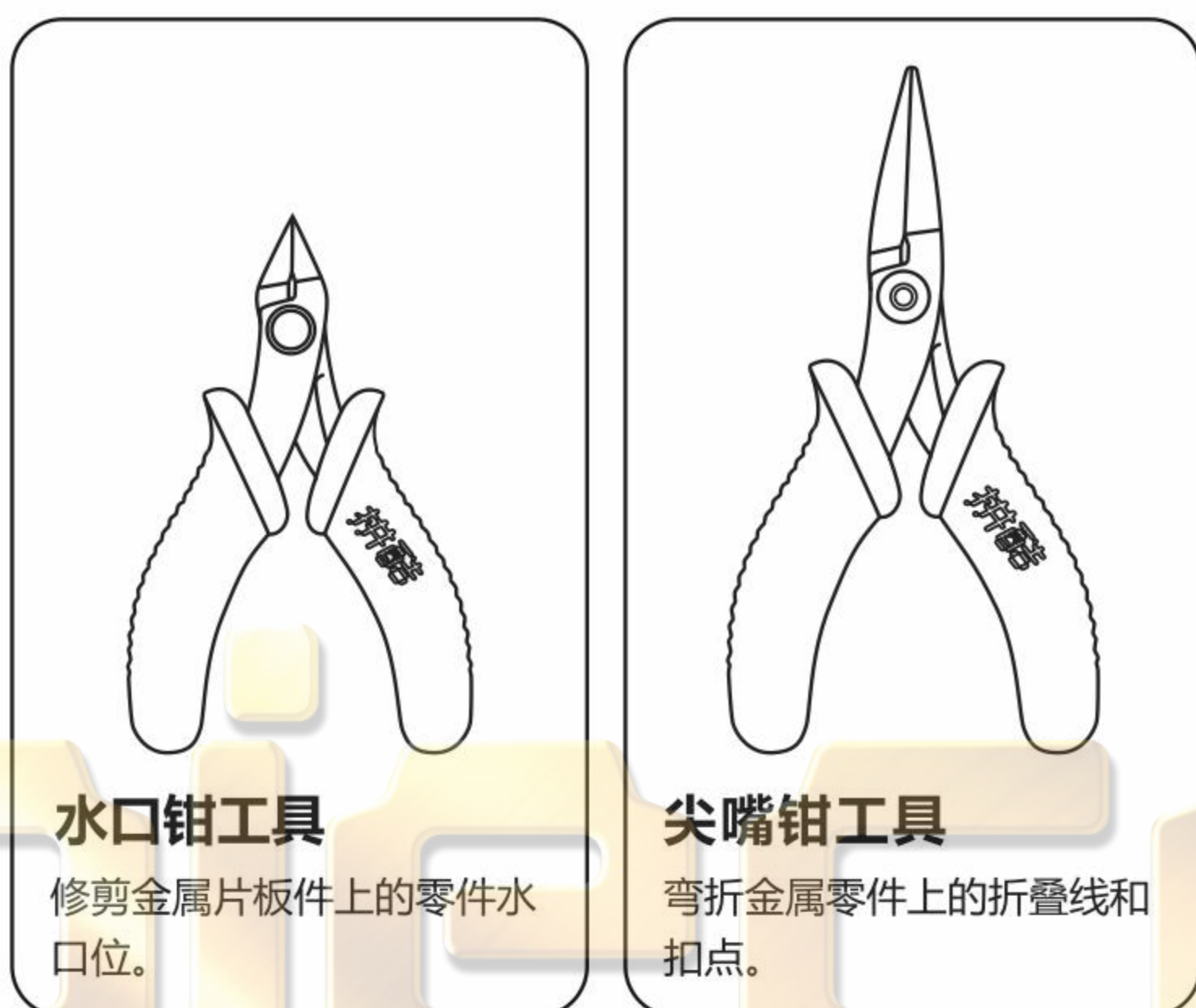

水口钳工具

修剪金属片板件上的零件水口位。

尖嘴钳工具

弯折金属零件上的折叠线和扣点。

建议使用拼酷正品拼装工具（水口钳、尖嘴钳），拼装时更省心、省力，拼装后作品更精细、美观！

⚠️ 请小心处理金属边料，以防划伤

#### • 拼装方法:

##### a. 取下零件



使用水口钳剪断金属零件上的水口，将需要的金属零件从金属片板上取下。

##### b. 识别零件



识别金属零件上的扣点、折叠线、扣孔的样子。

##### c. 折叠零件

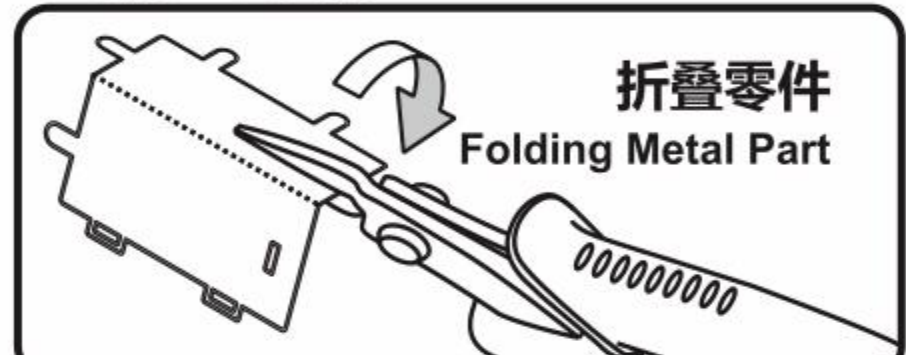

使用尖嘴钳，参照拼装说明书将金属零件折成形状。

##### d. 固定零件



● 插入扣孔，平折 90°



▲ 插入扣孔，旋转 90°

#### • 注意事项:



剪金属零件时请剪零件“水口位”，请勿将“扣点”当成“水口位”剪下，每次剪零件时请仅剪当前步骤的零件，切勿一次性将所有零件全部剪下，避免丢失；  
当遇到折叠线的零件，请注意金属片的正反面及拼折方向，请按照说明书说明的方向，轻剪慢折，最好一次折叠完成，请勿反复折叠，避免零件损坏。

### 拼装步骤

#### Step 1

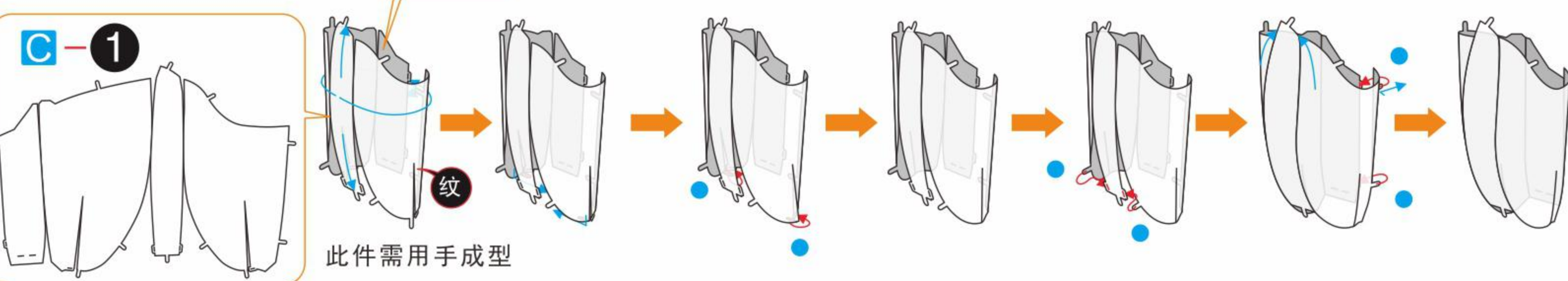

#### Step 2

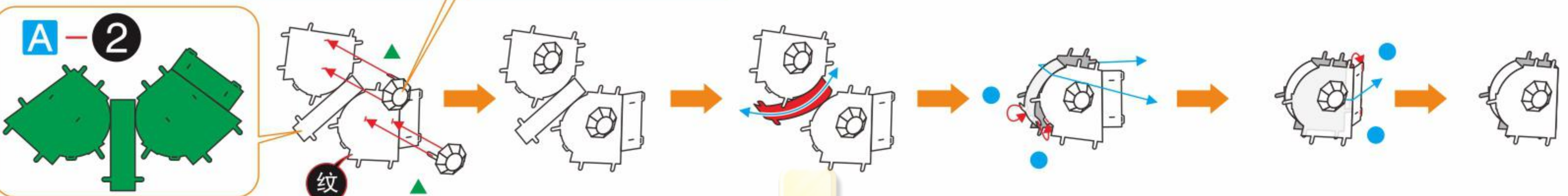

#### Step 3

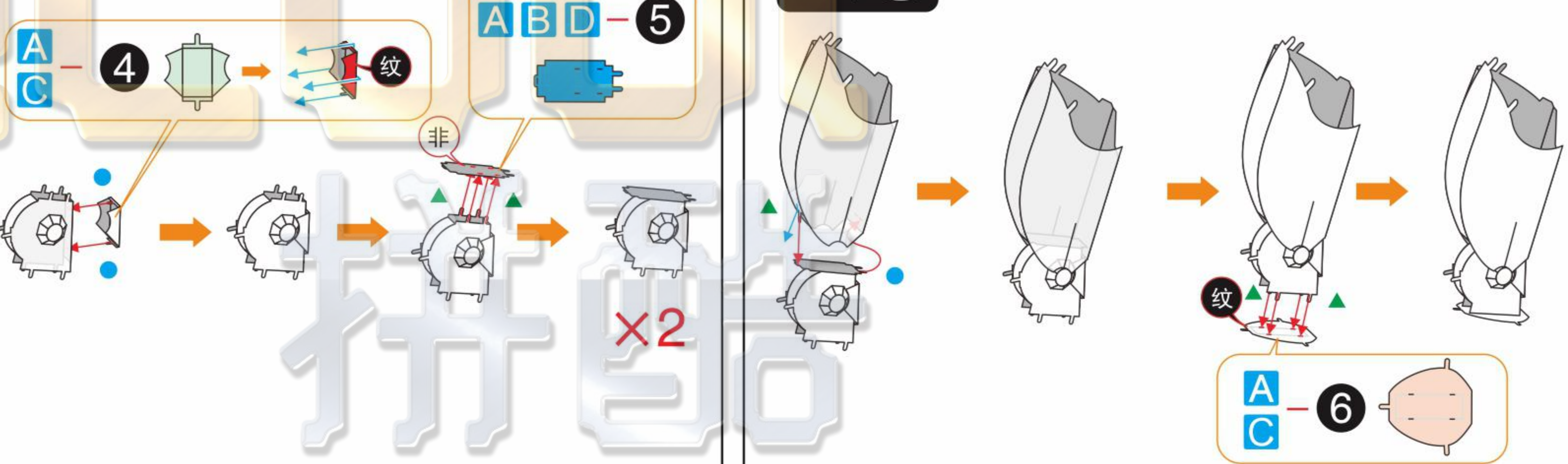

#### Step 4

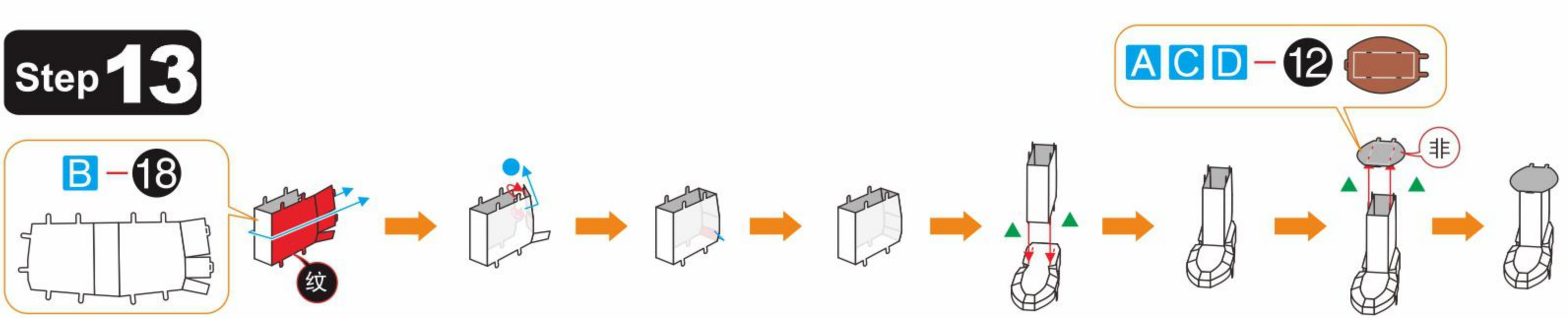
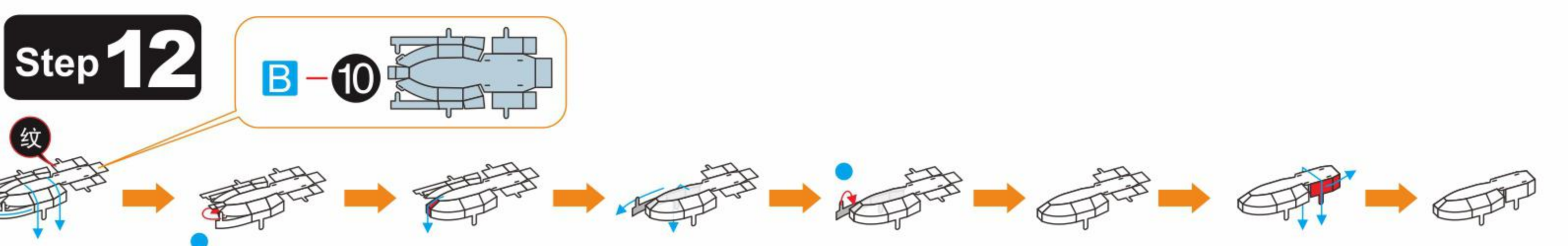
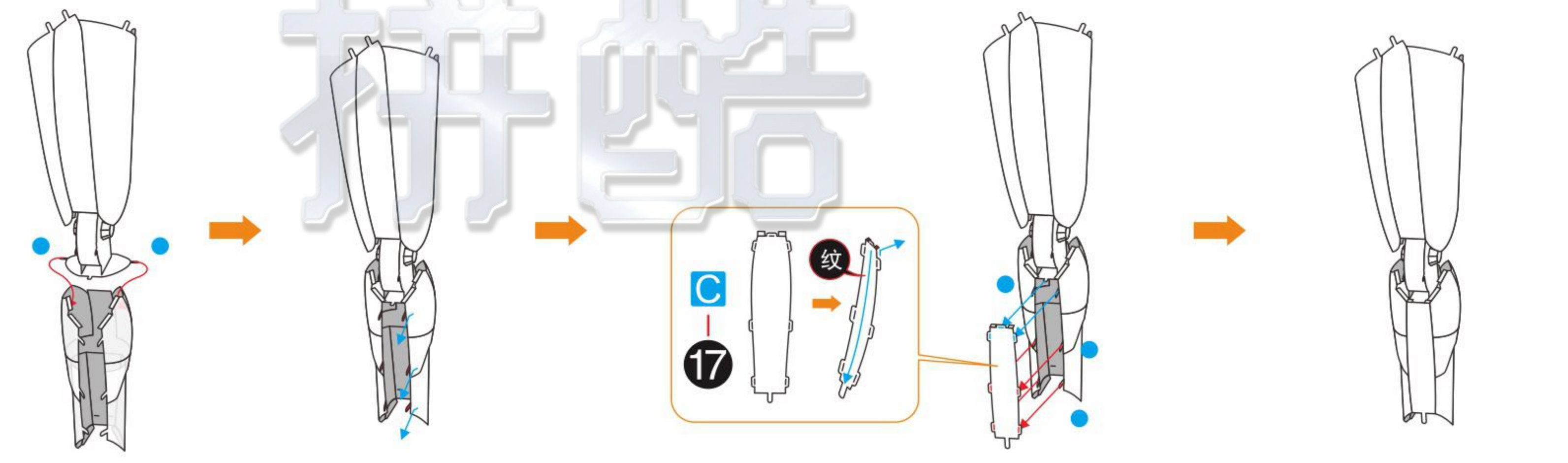
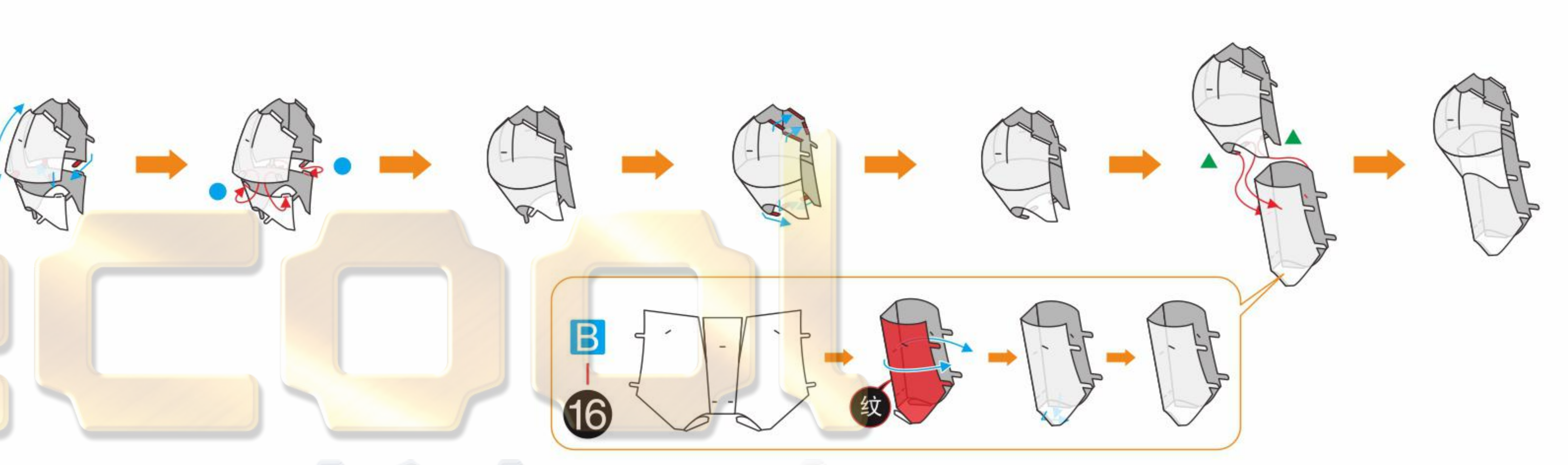
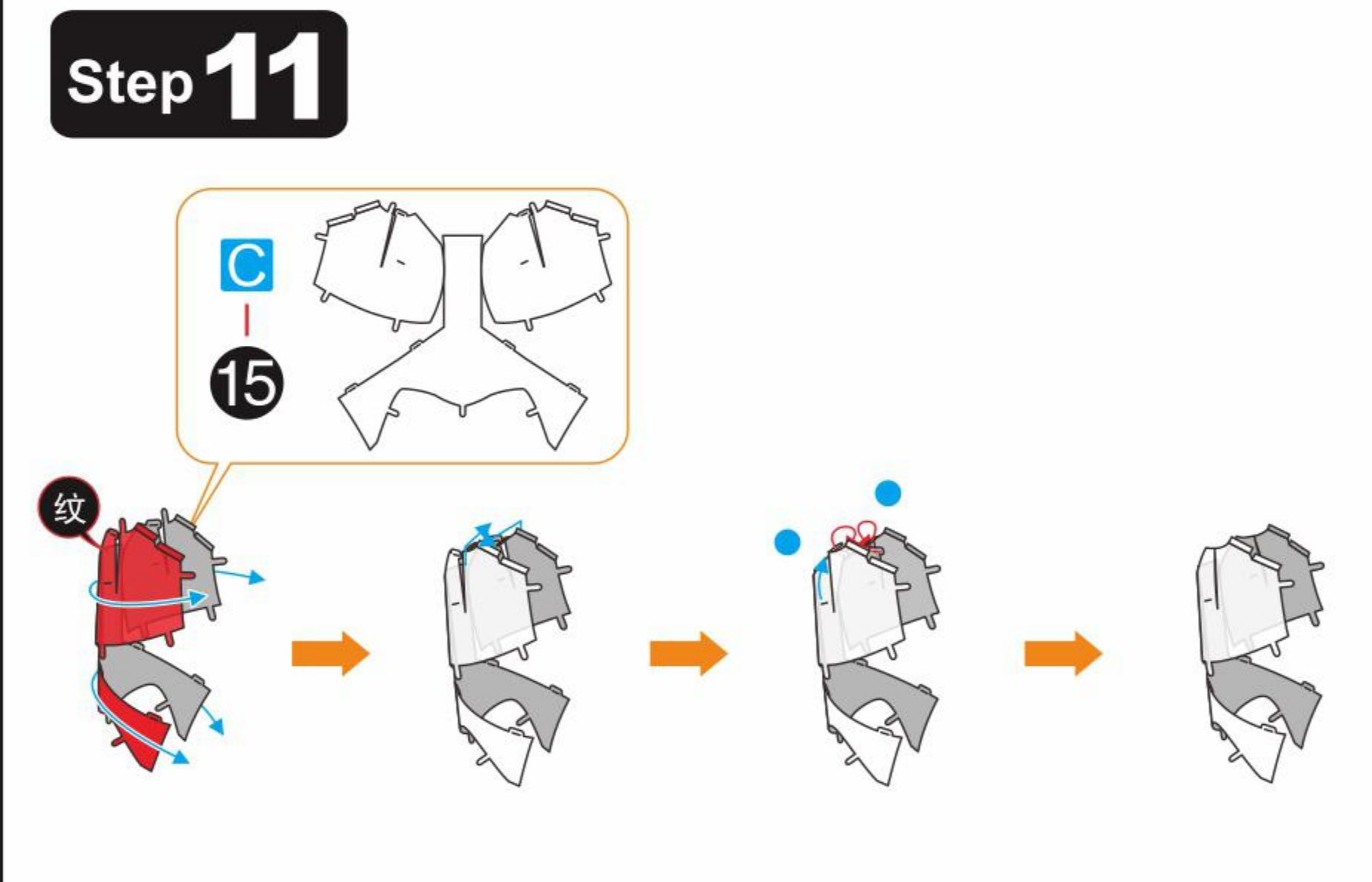
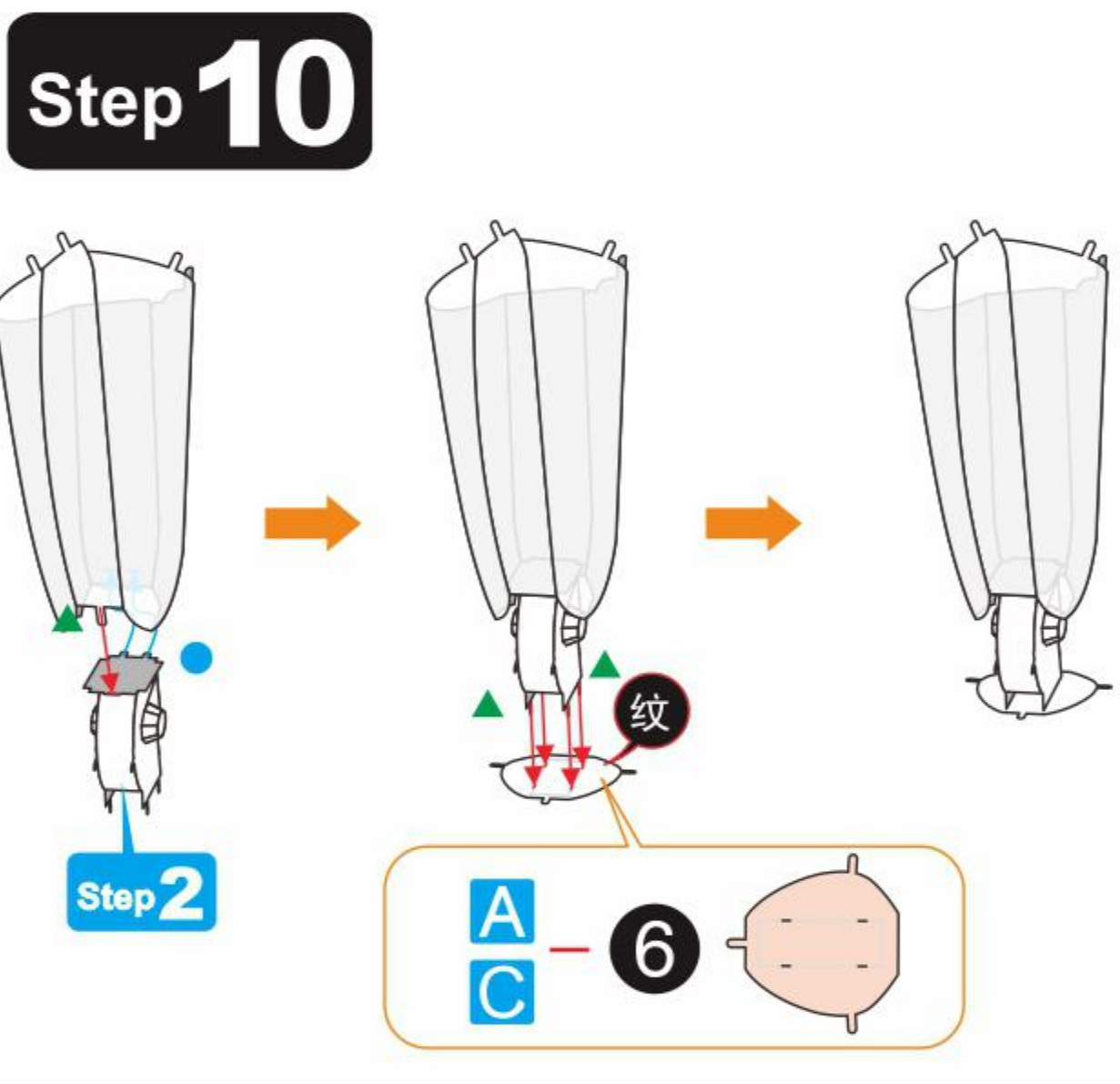
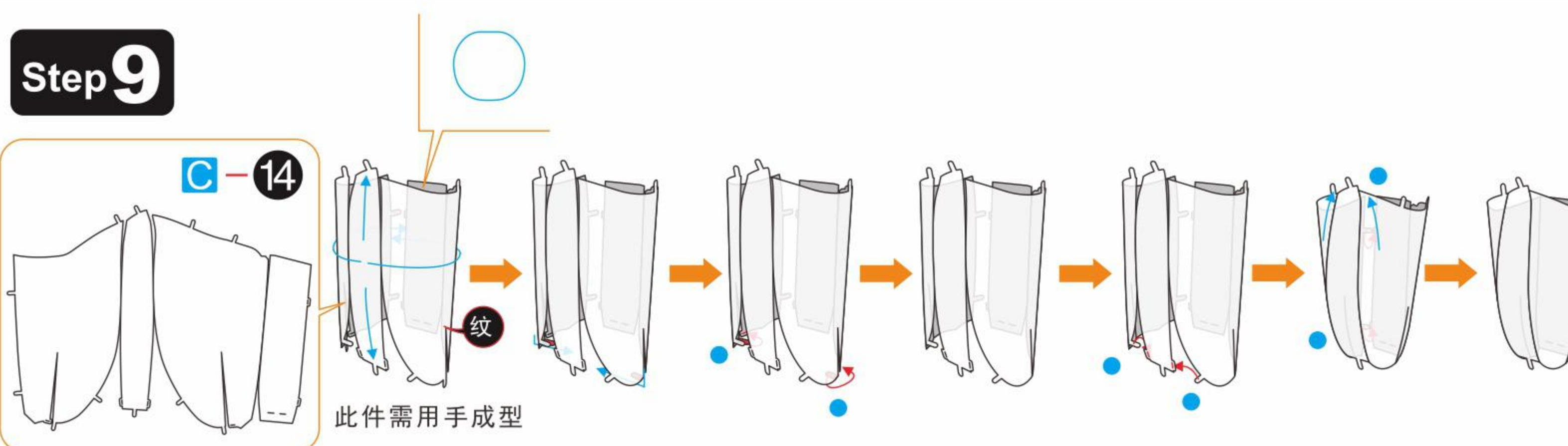
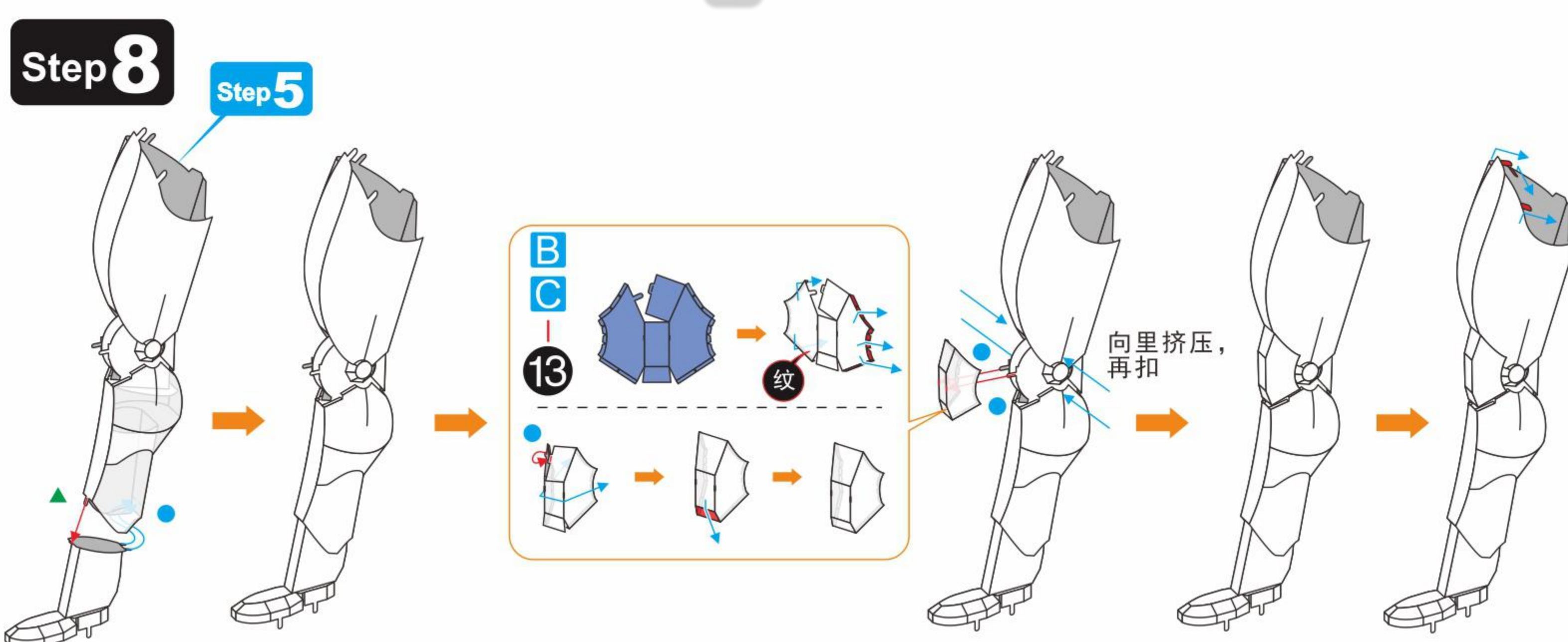
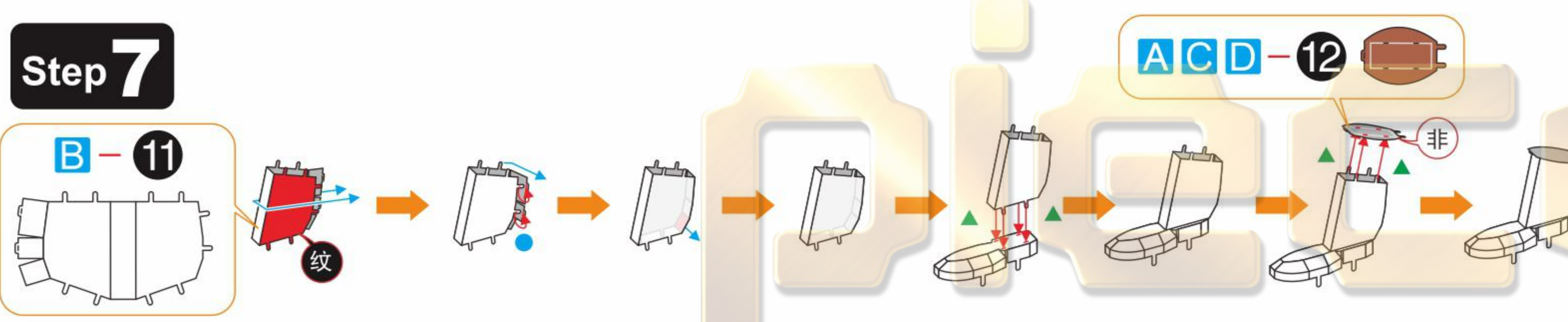
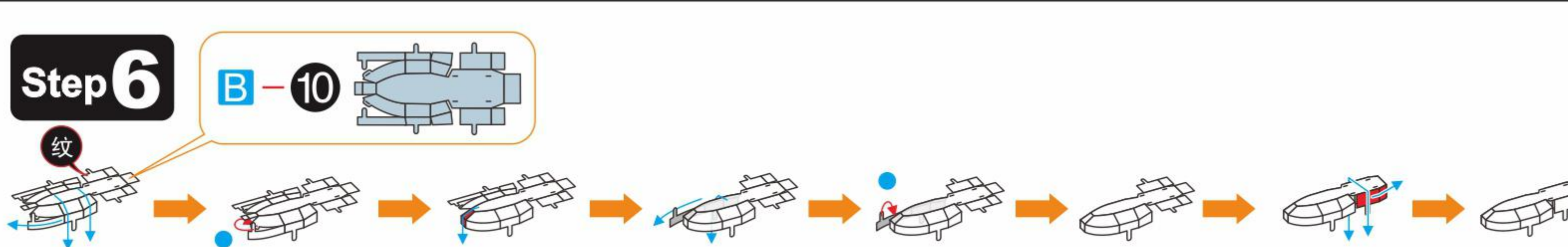
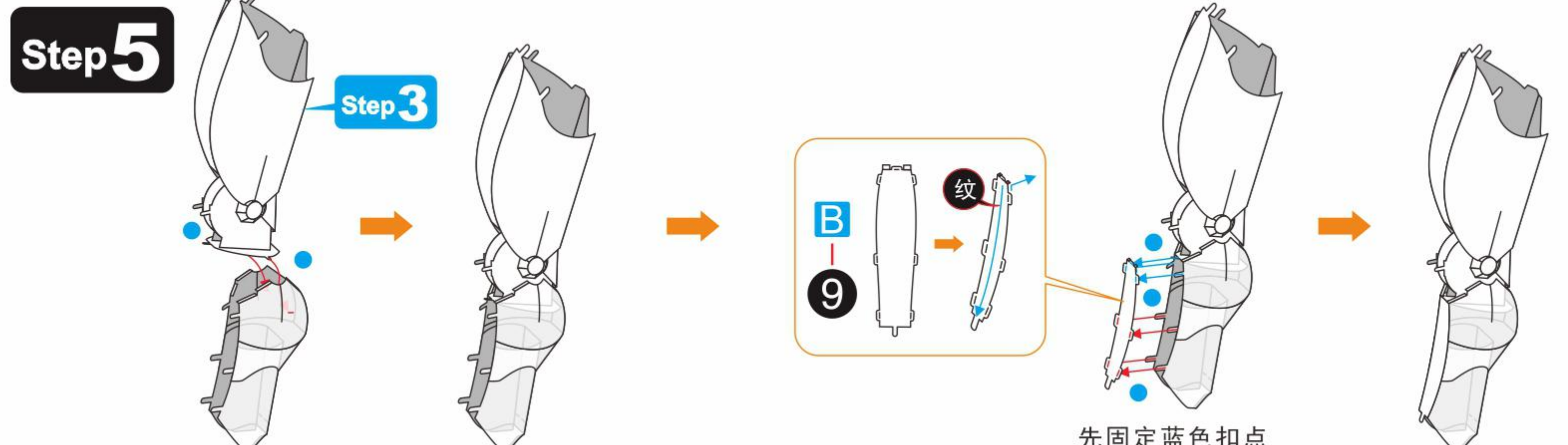
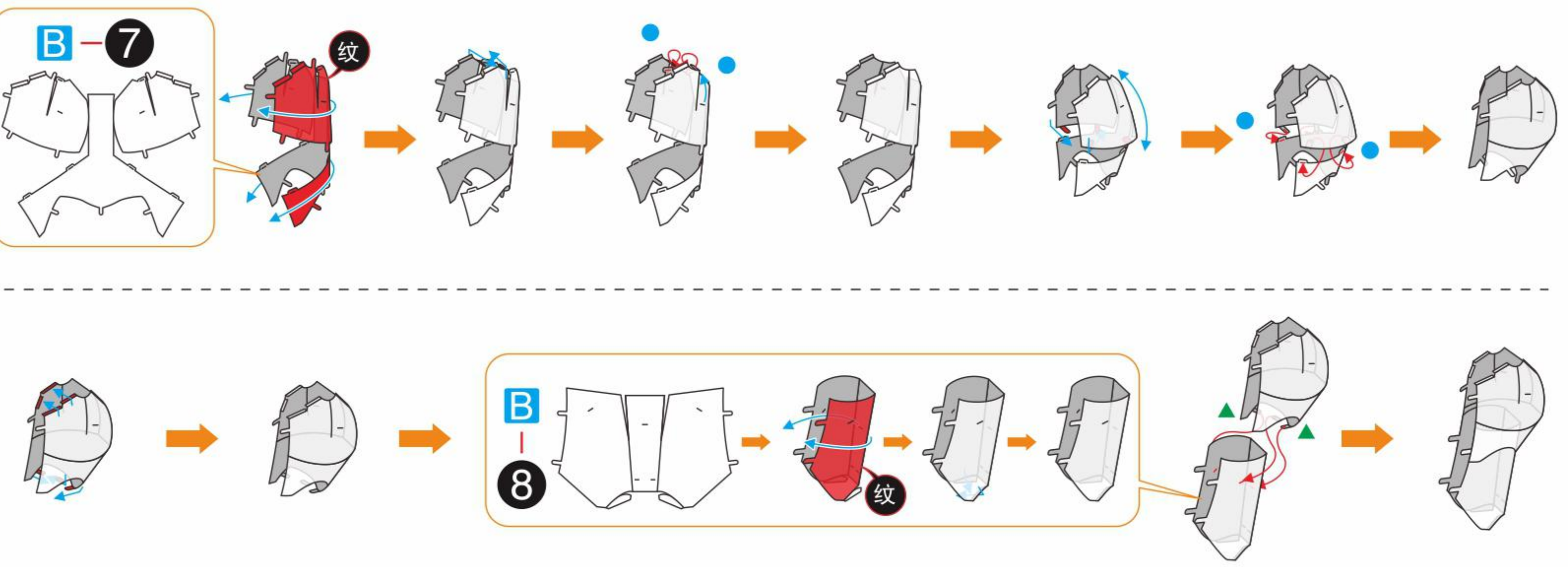



**Step 14**

Step 13

向里挤压, 再扣

**Step 15**

B-19

B-20

B-21

**Step 16**

B-22

B-23

B-24

D-25

先扣蓝色扣点, 再扣红色扣点.

Step 8

Step 14

**Step 17**

A-26

B-27

装上去之后需调整底座, 使底座水平于桌面上.

B C-28

B C-29

A C-30

X2

X2

**Step 18**

B-31

C-32

**Step 19**

B-33

C-32

**Step 20**

Step 18

Step 19

**Step 21**

C-34

B-35

**Step 22**

C-36

A-37

**Step 23**

C-38

C-39

Step 21

Step 22

**Step 24**

A-40

C-32

**Step 25**

A-41

C-32

**Step 26**

Step 24

Step 25

先扣蓝色扣点, 再扣红色扣点.

Step 20

**Step 27**

A-43

B-42

C-44



Step 28

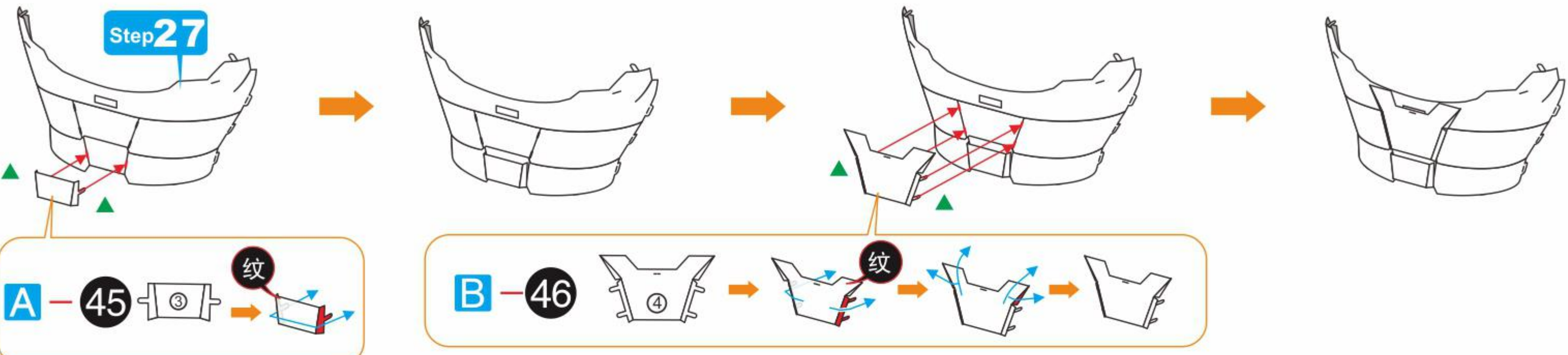

Step 29

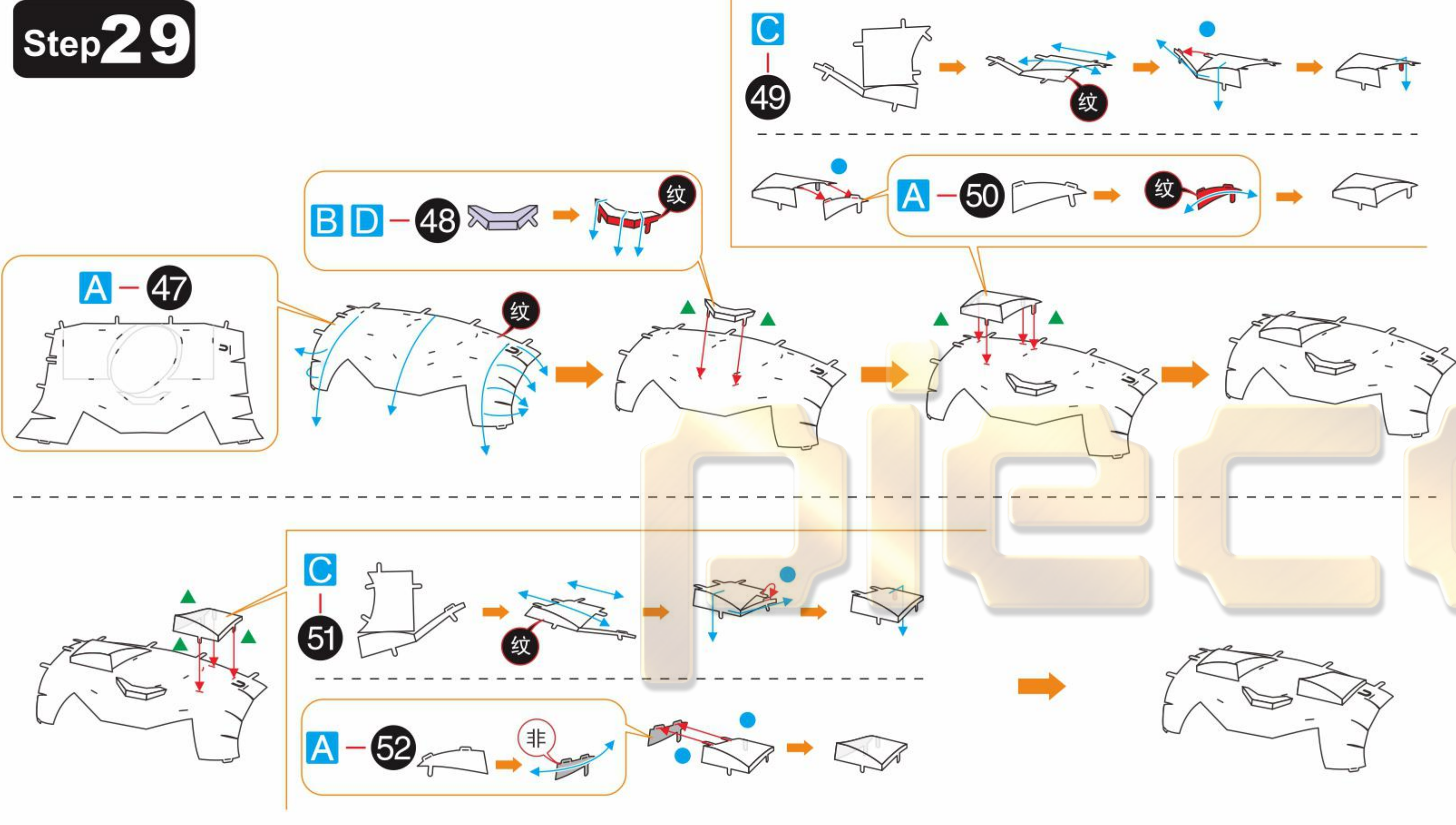

Step 30

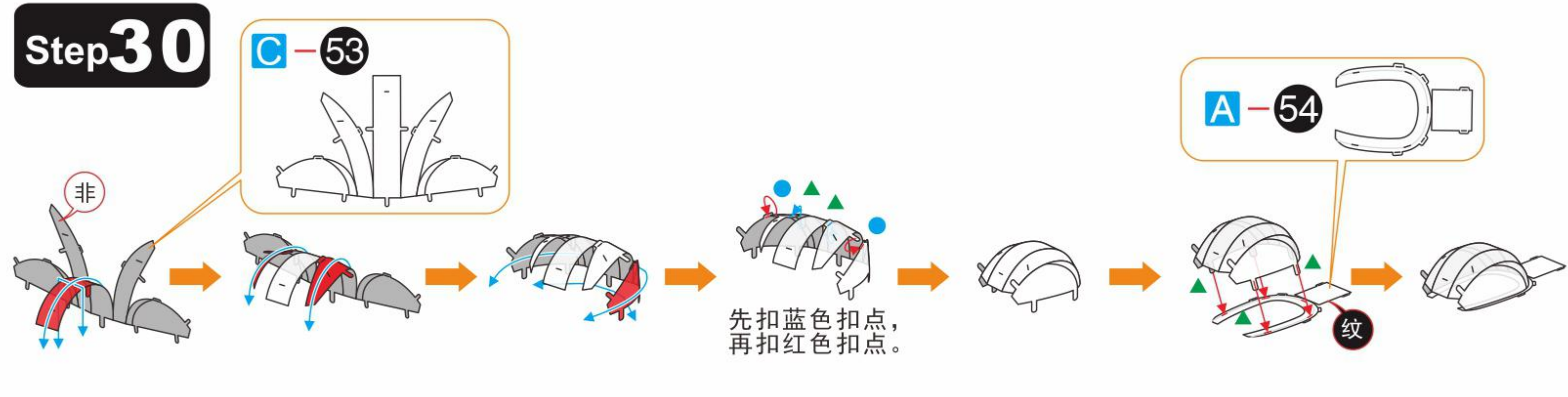

Step 31

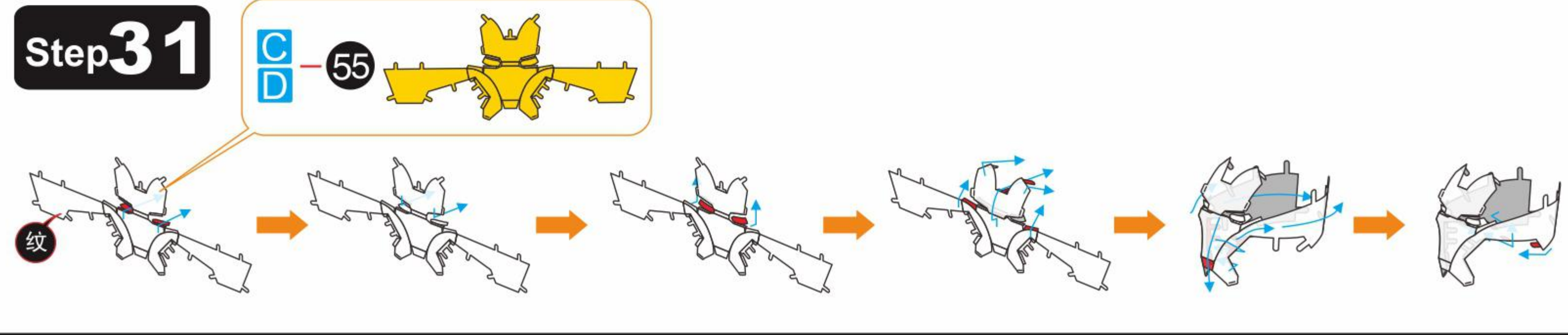

Step 34

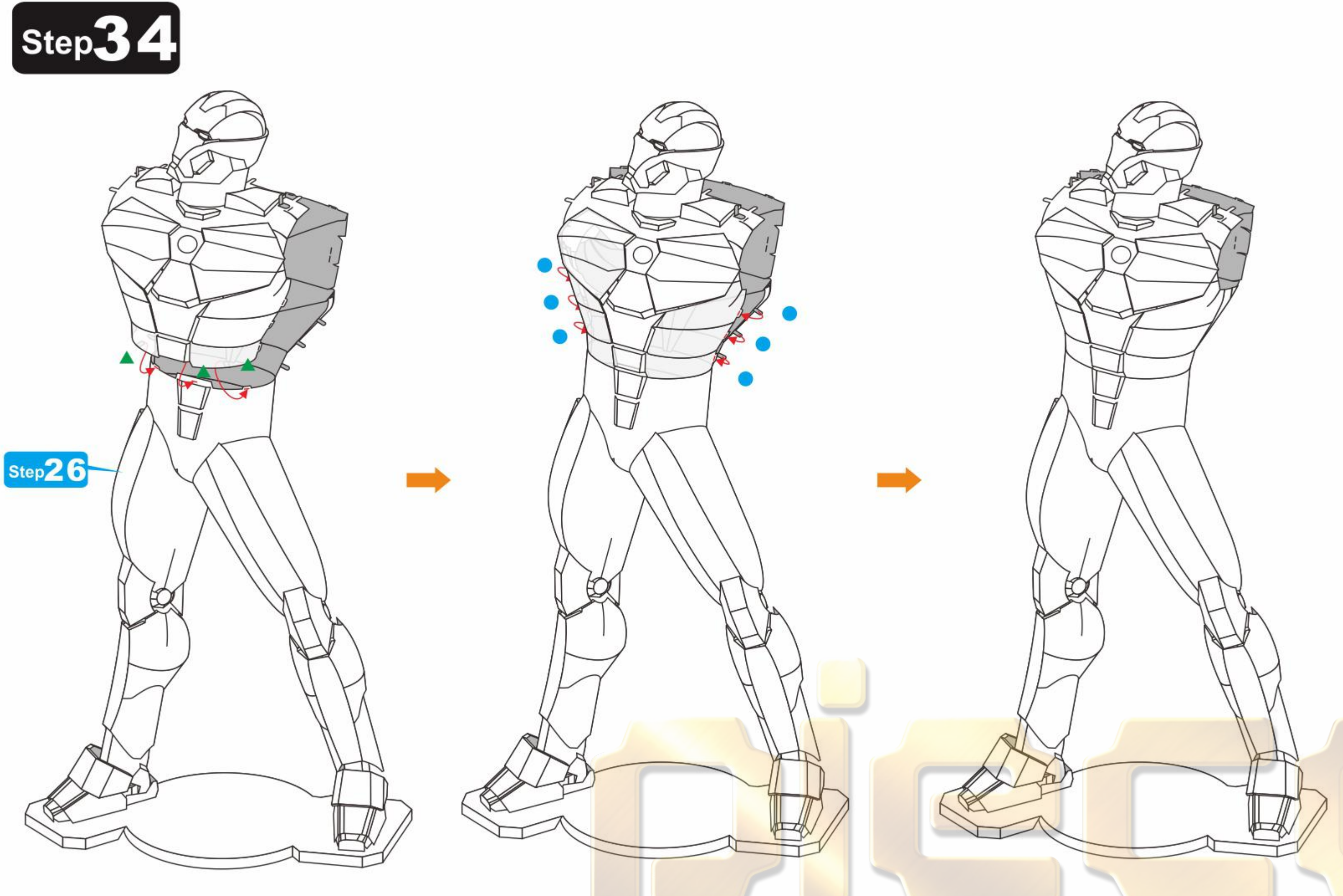

Step 35

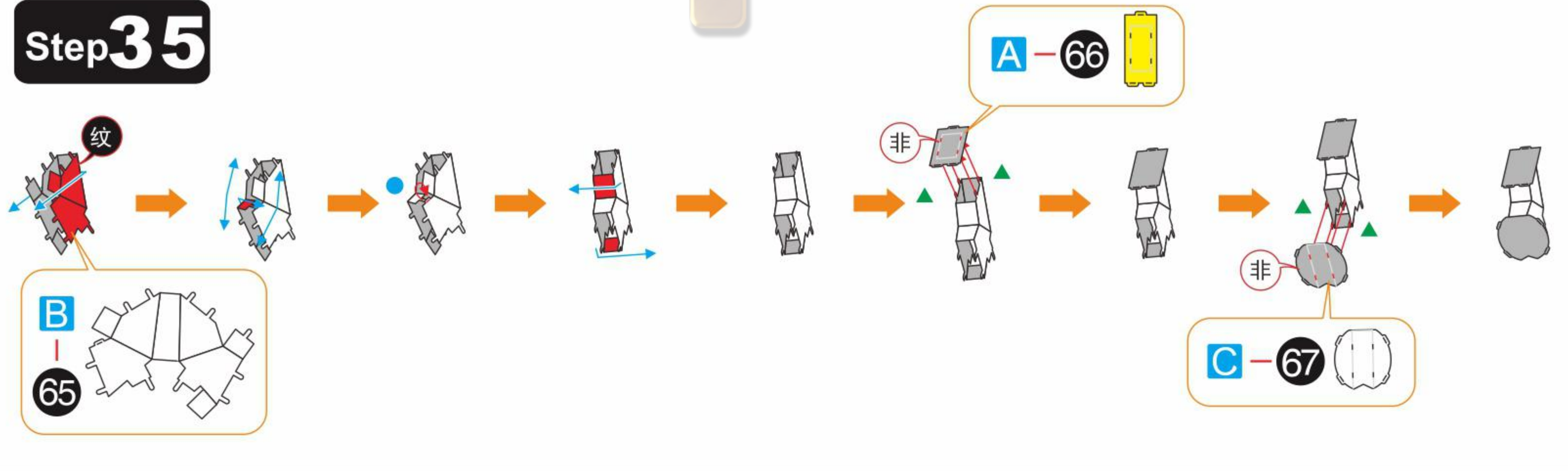

Step 36

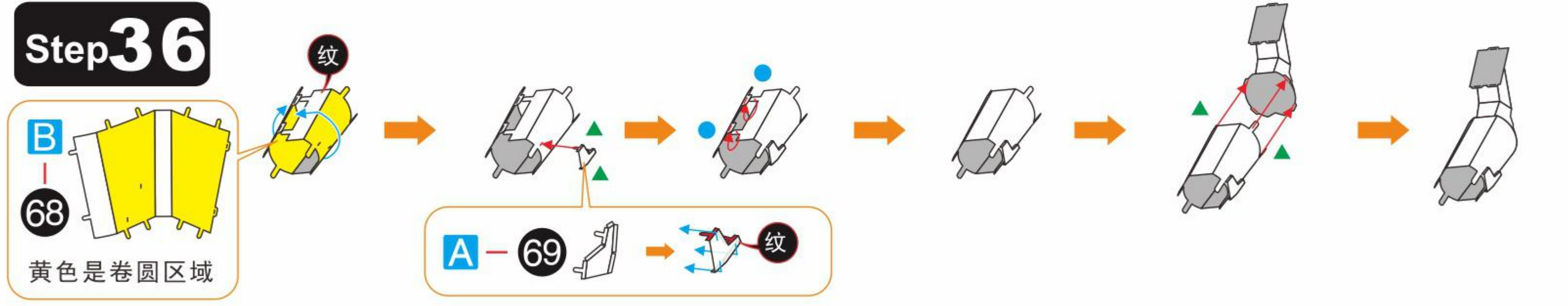

Step 37

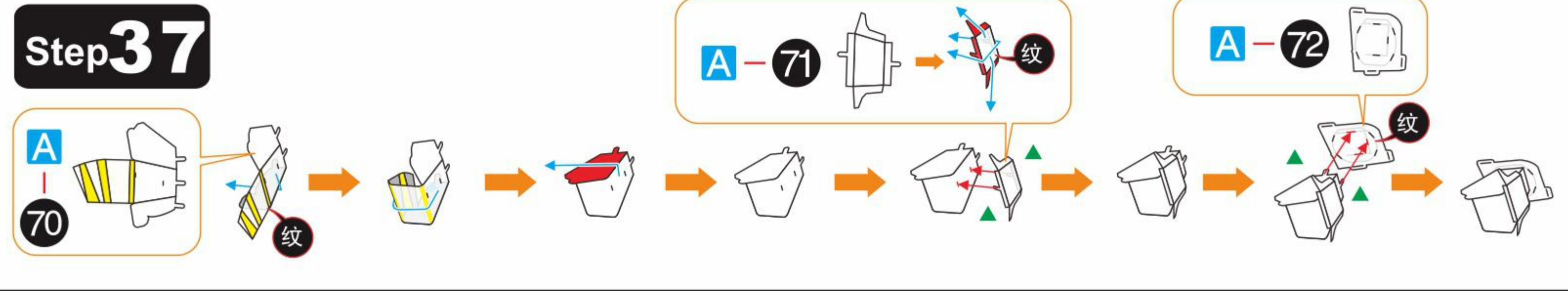

Step 32

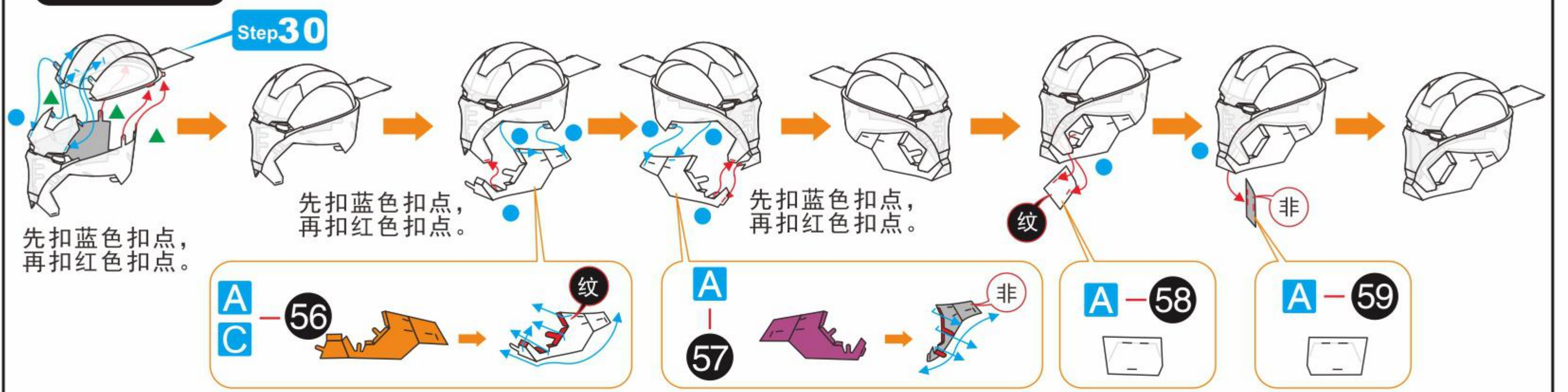

Step 33

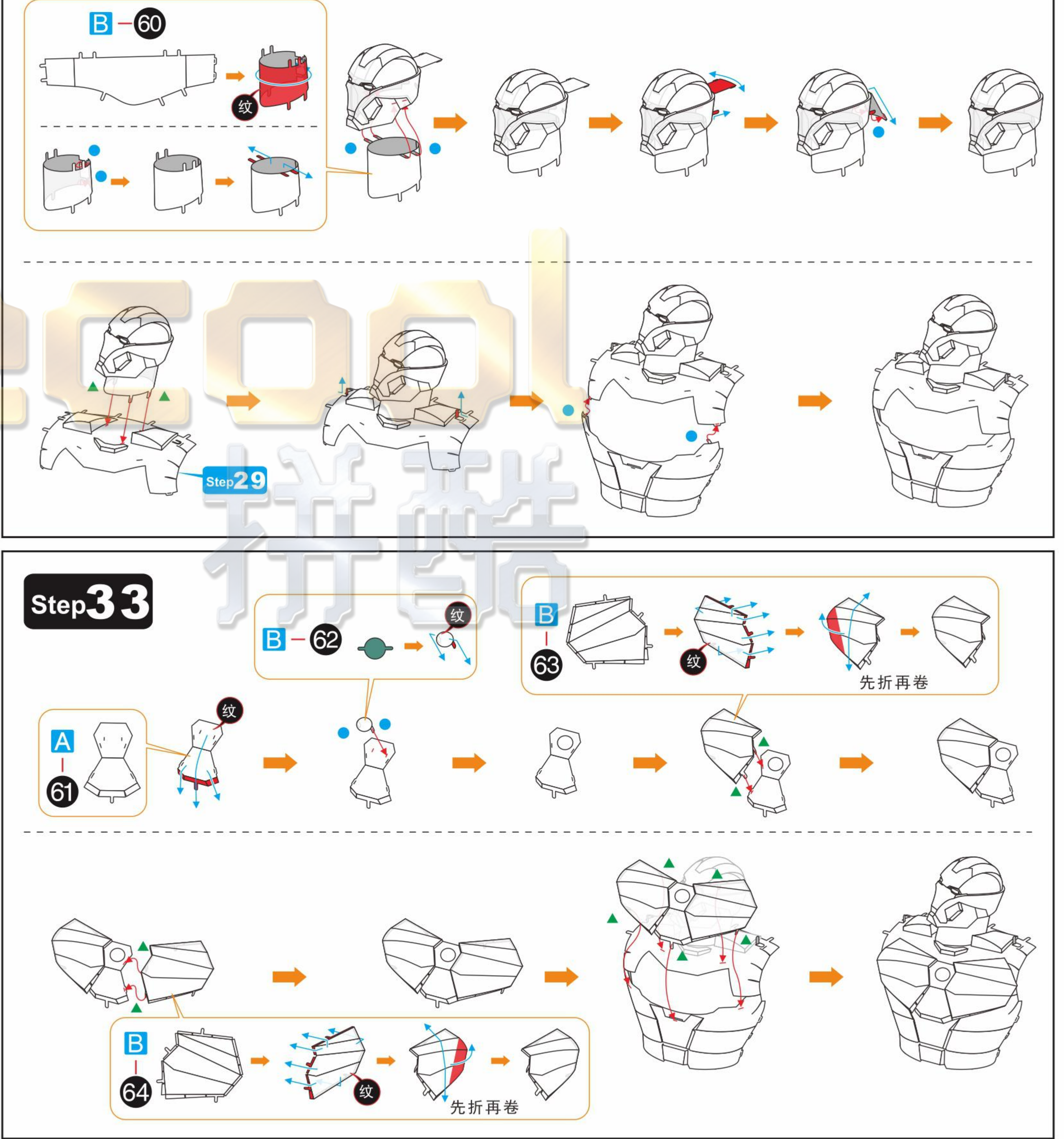

Step 38

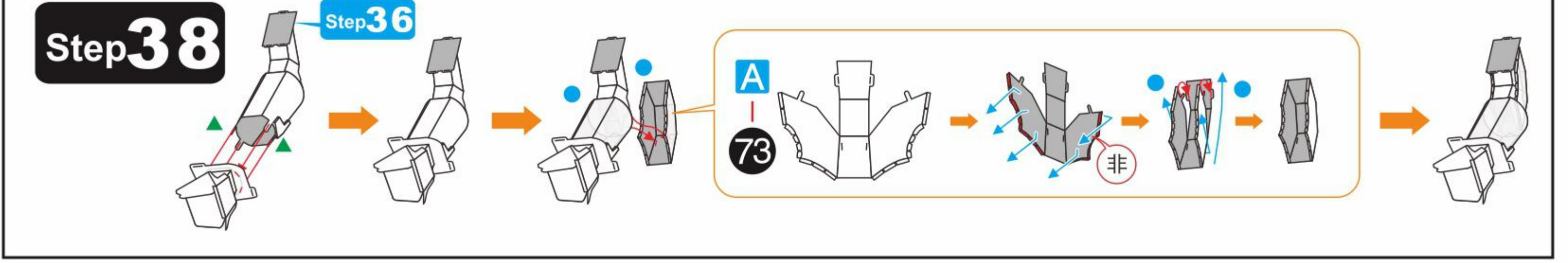

Step 39

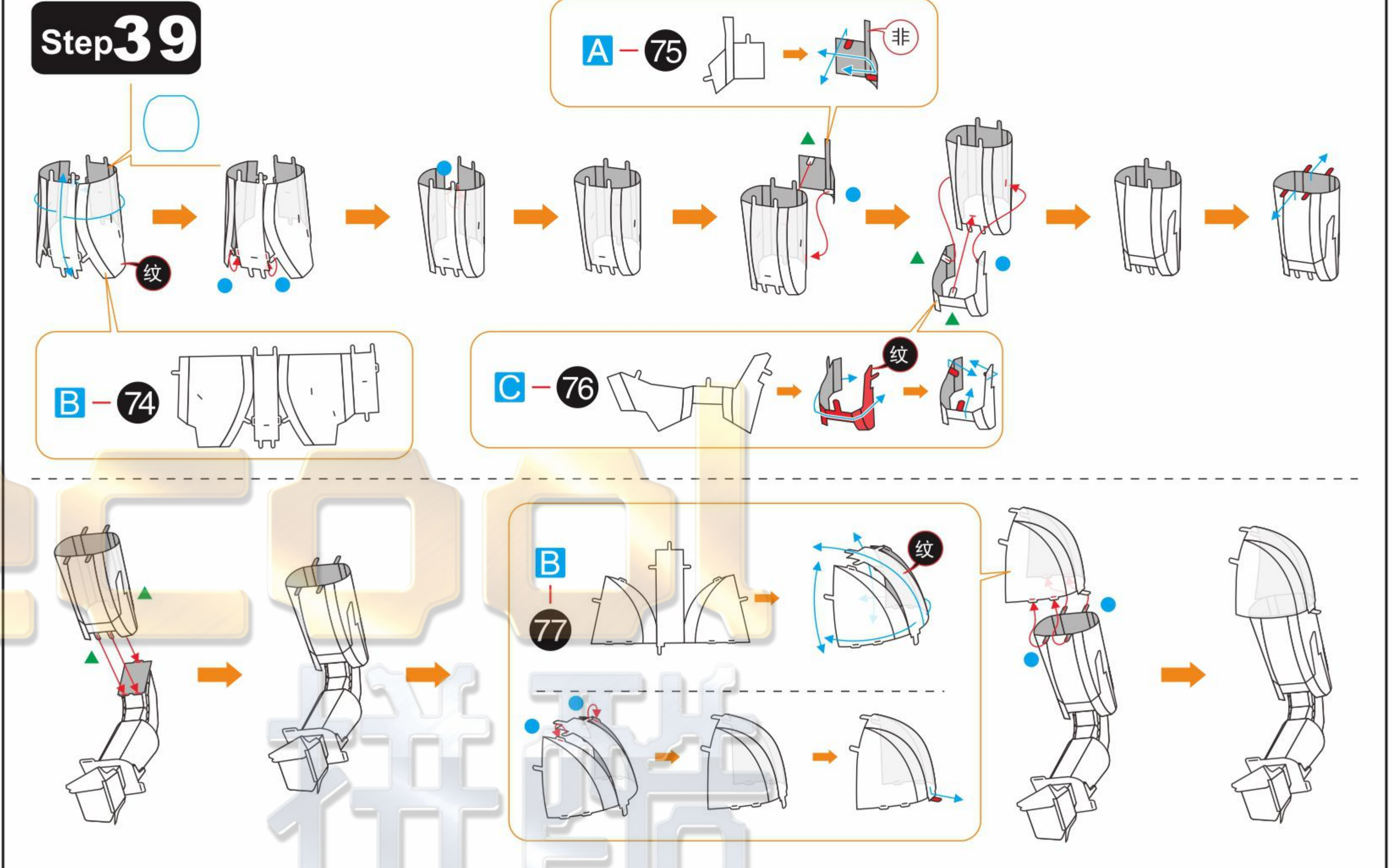

Step 40

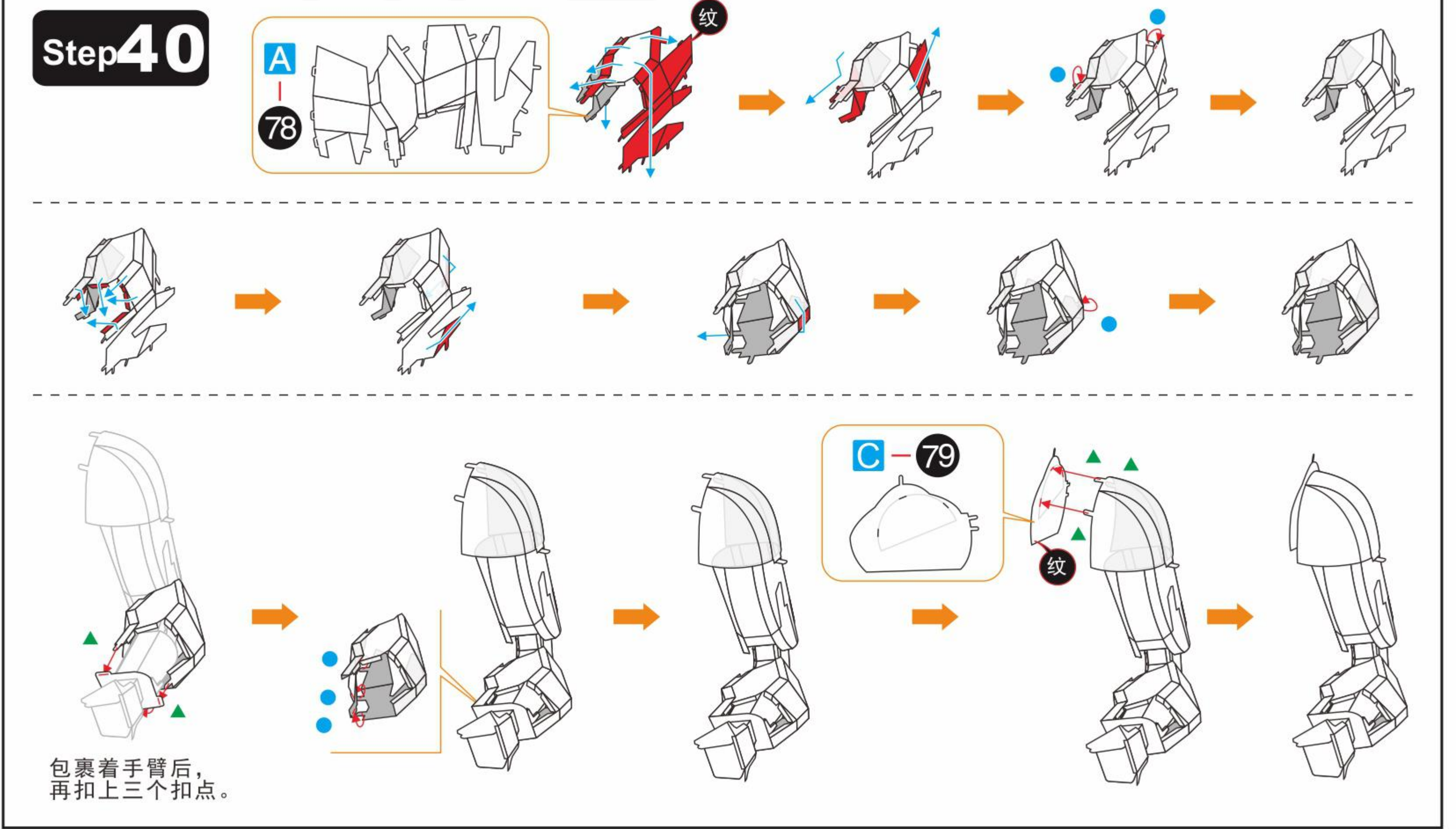



Step41

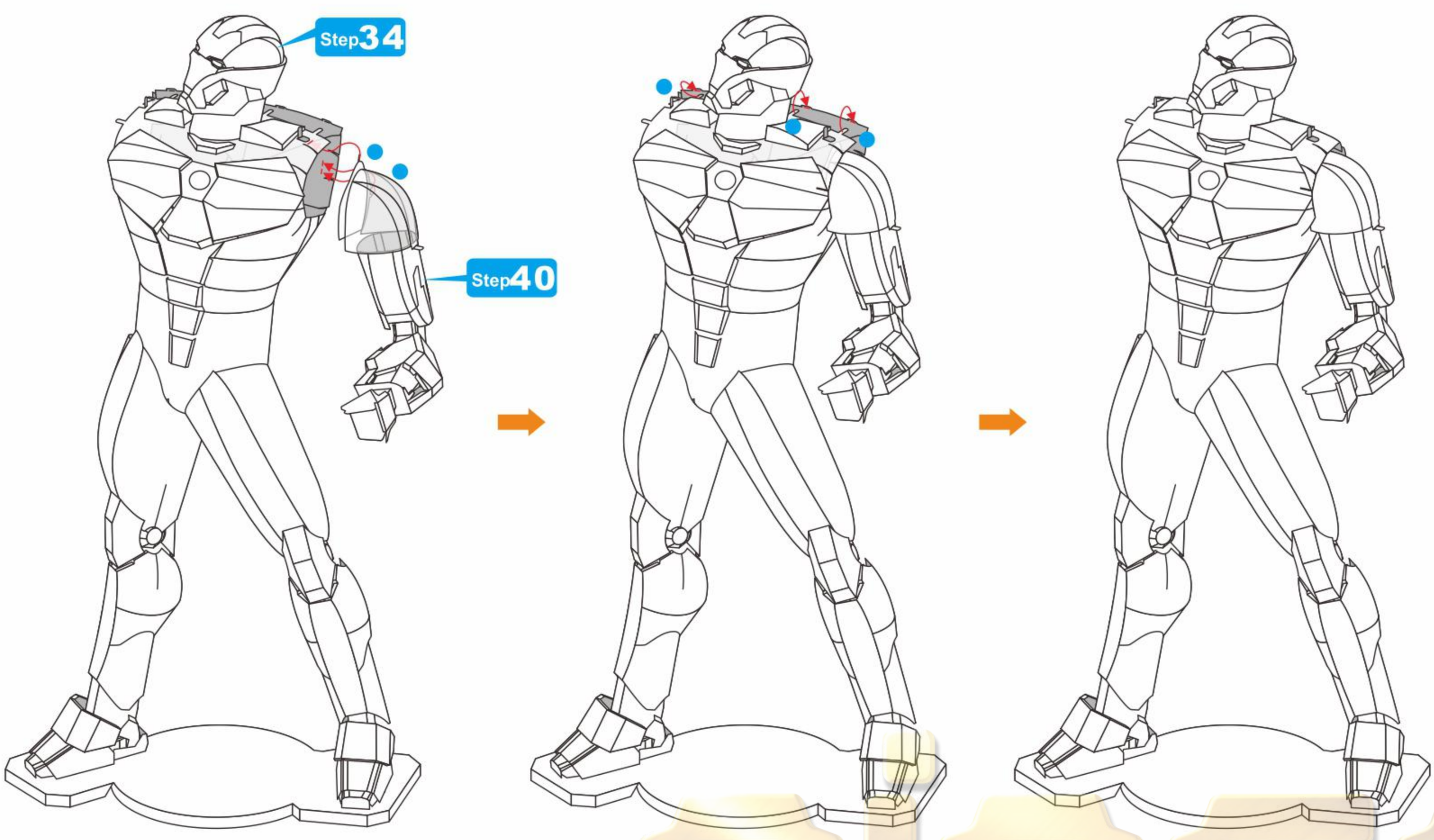

Step42

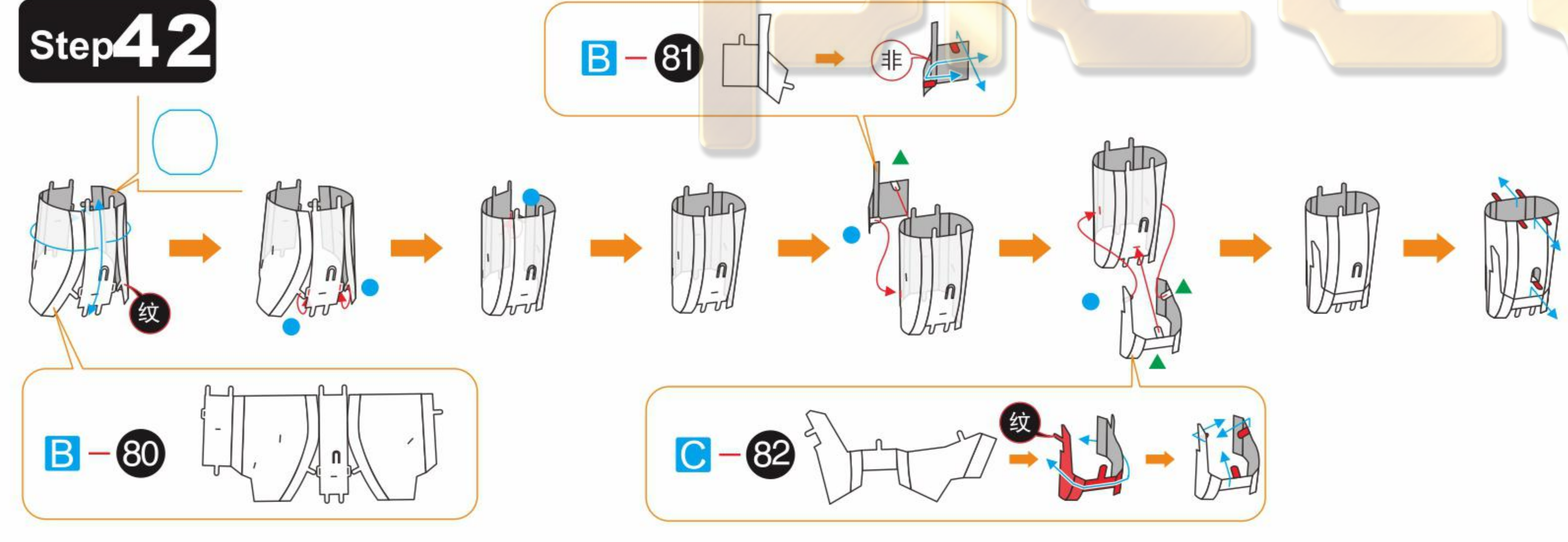

Step43

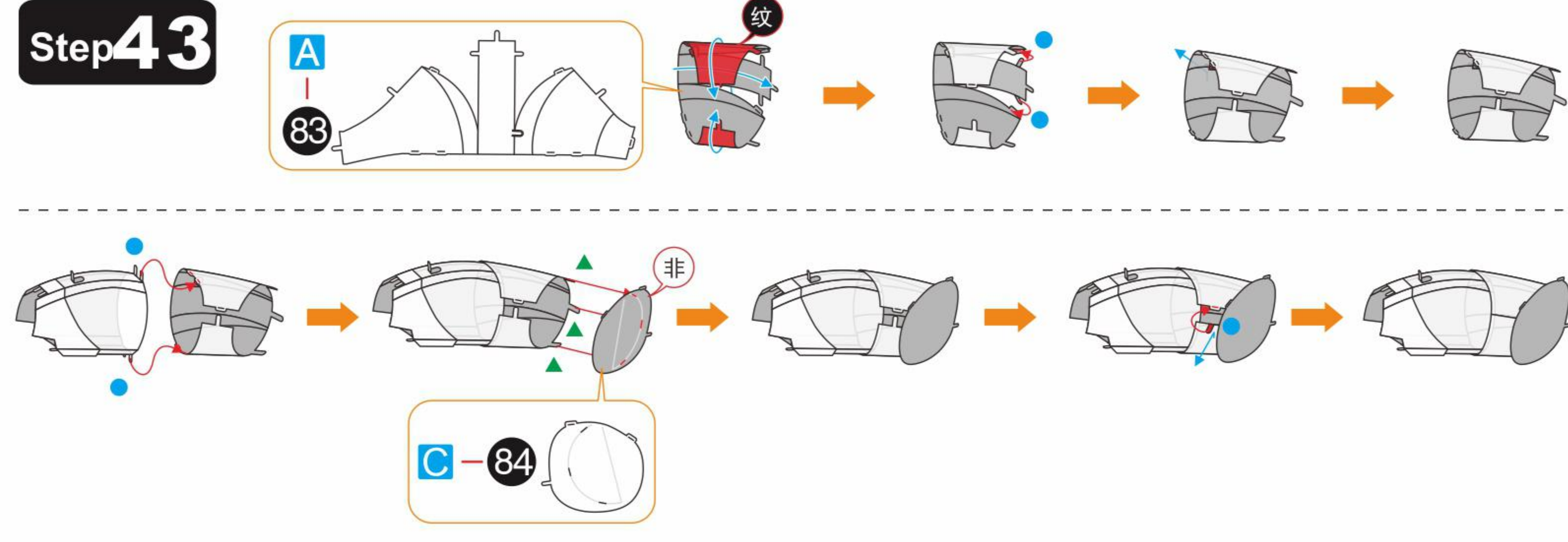

Step47

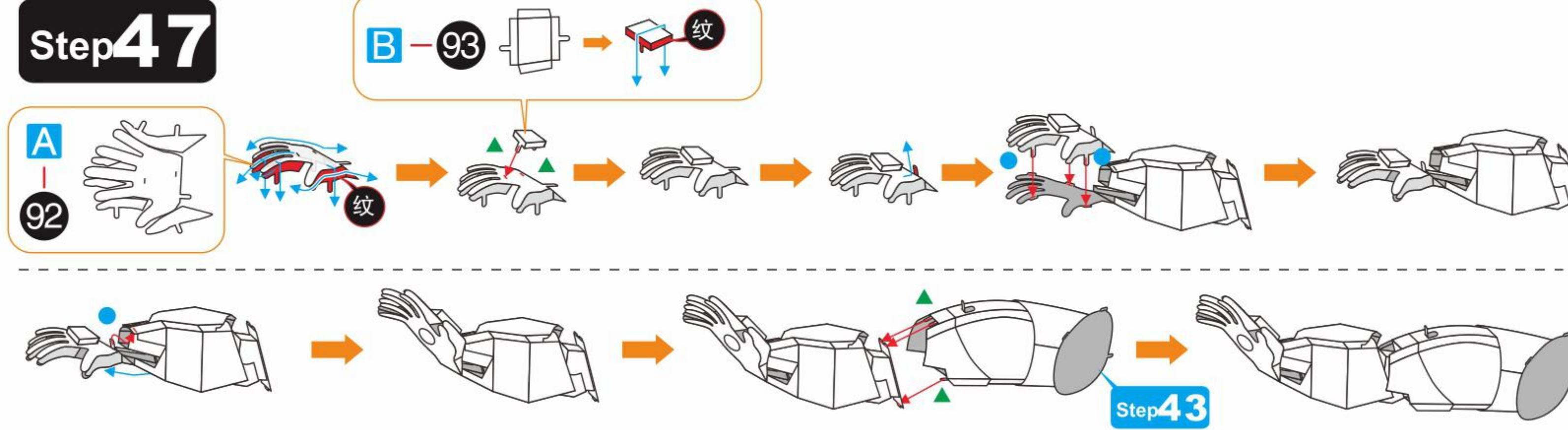

先扣蓝色扣点，再扣红色扣点。

Step41

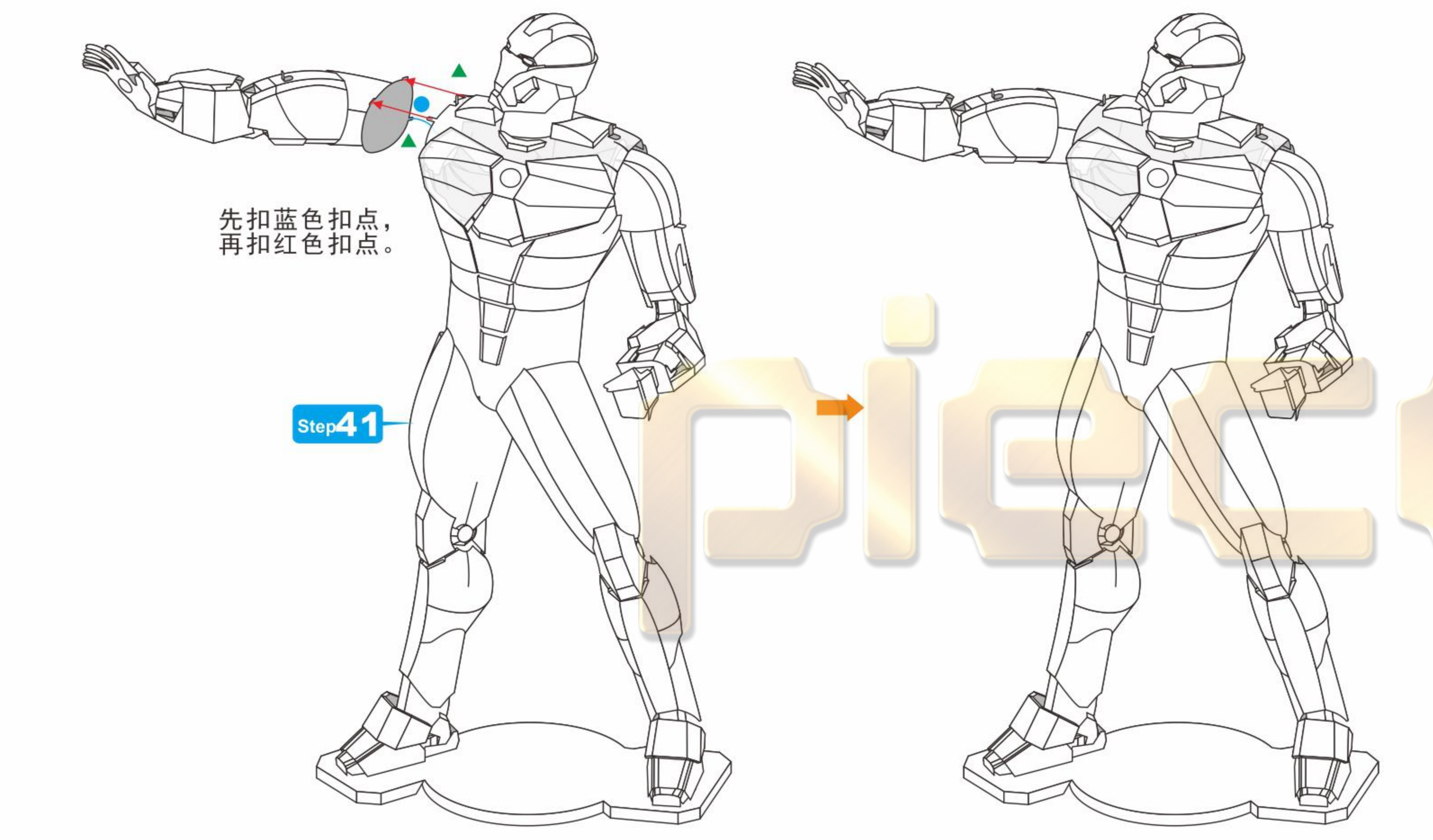

Step48

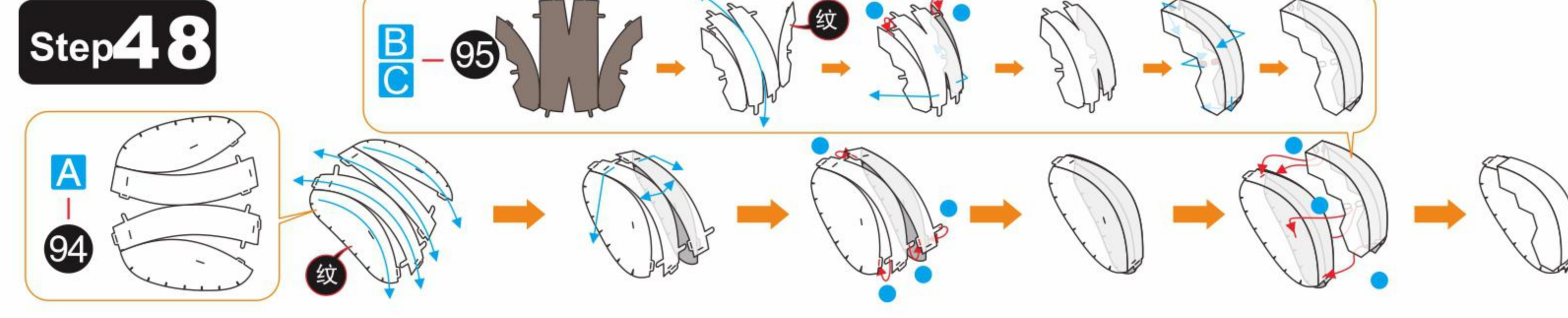

Step49

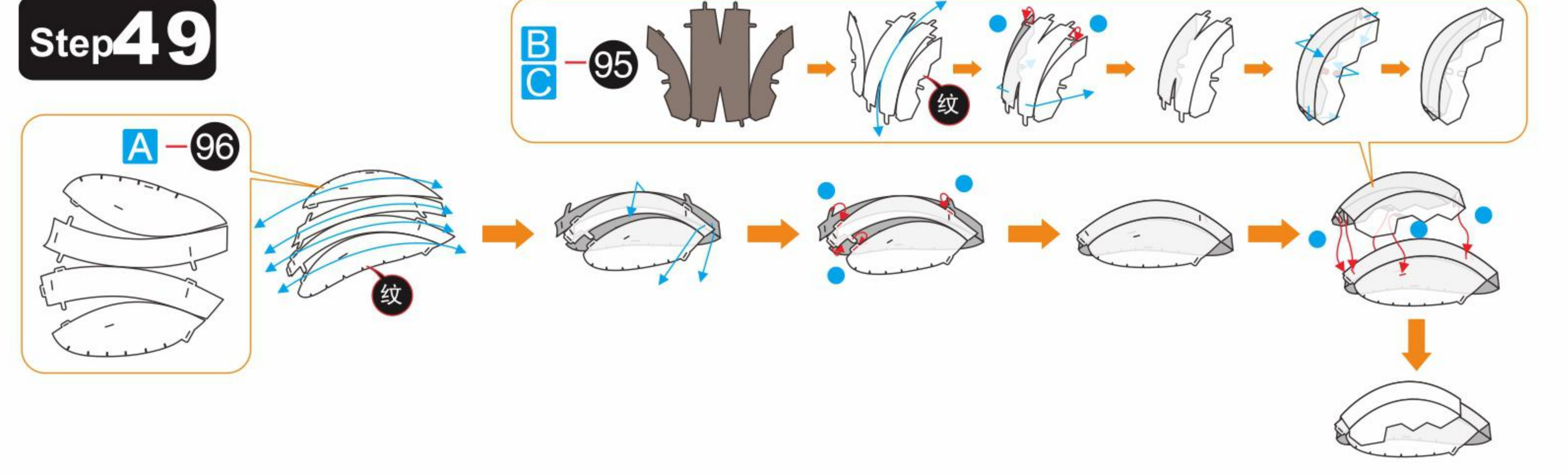

Step44

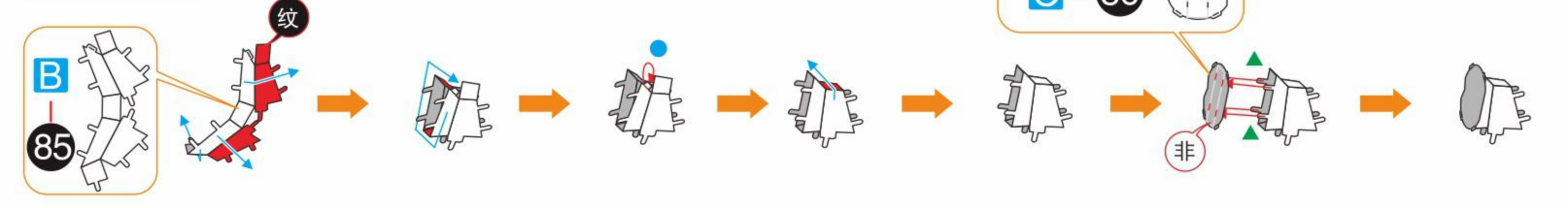

Step45

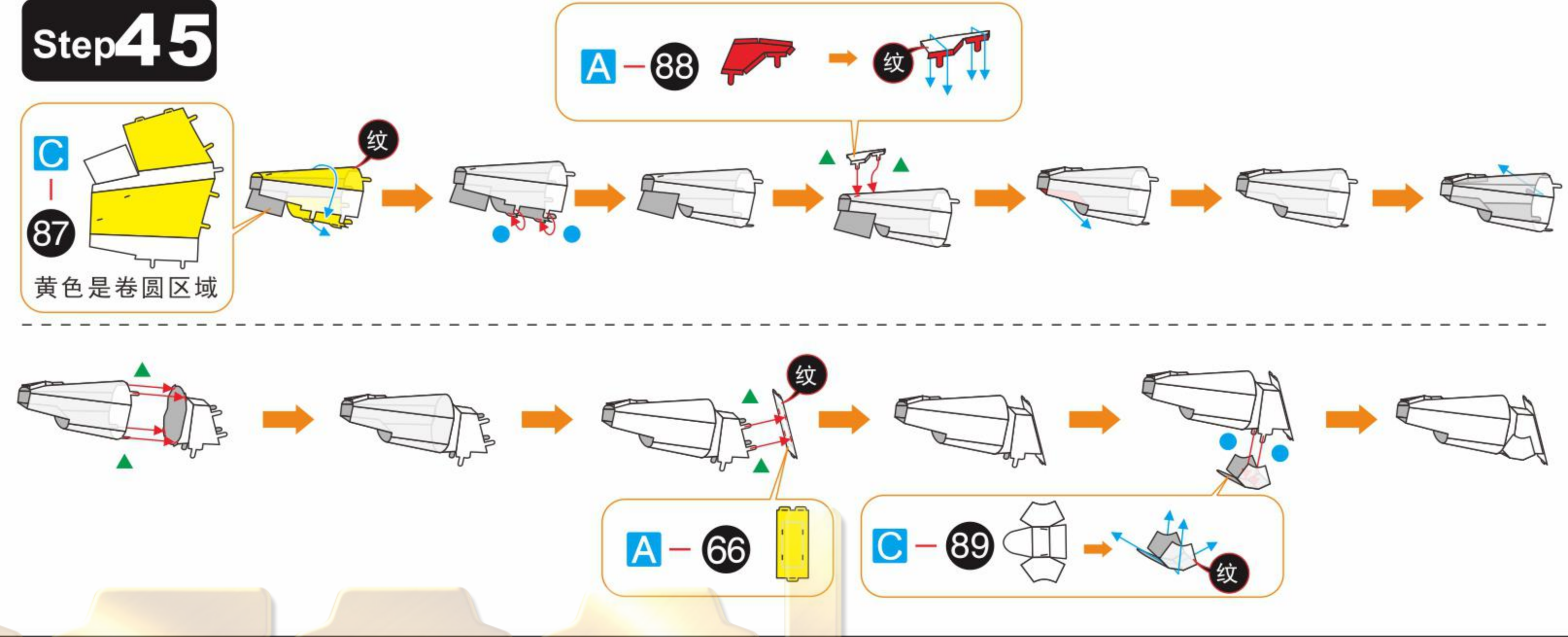

Step46

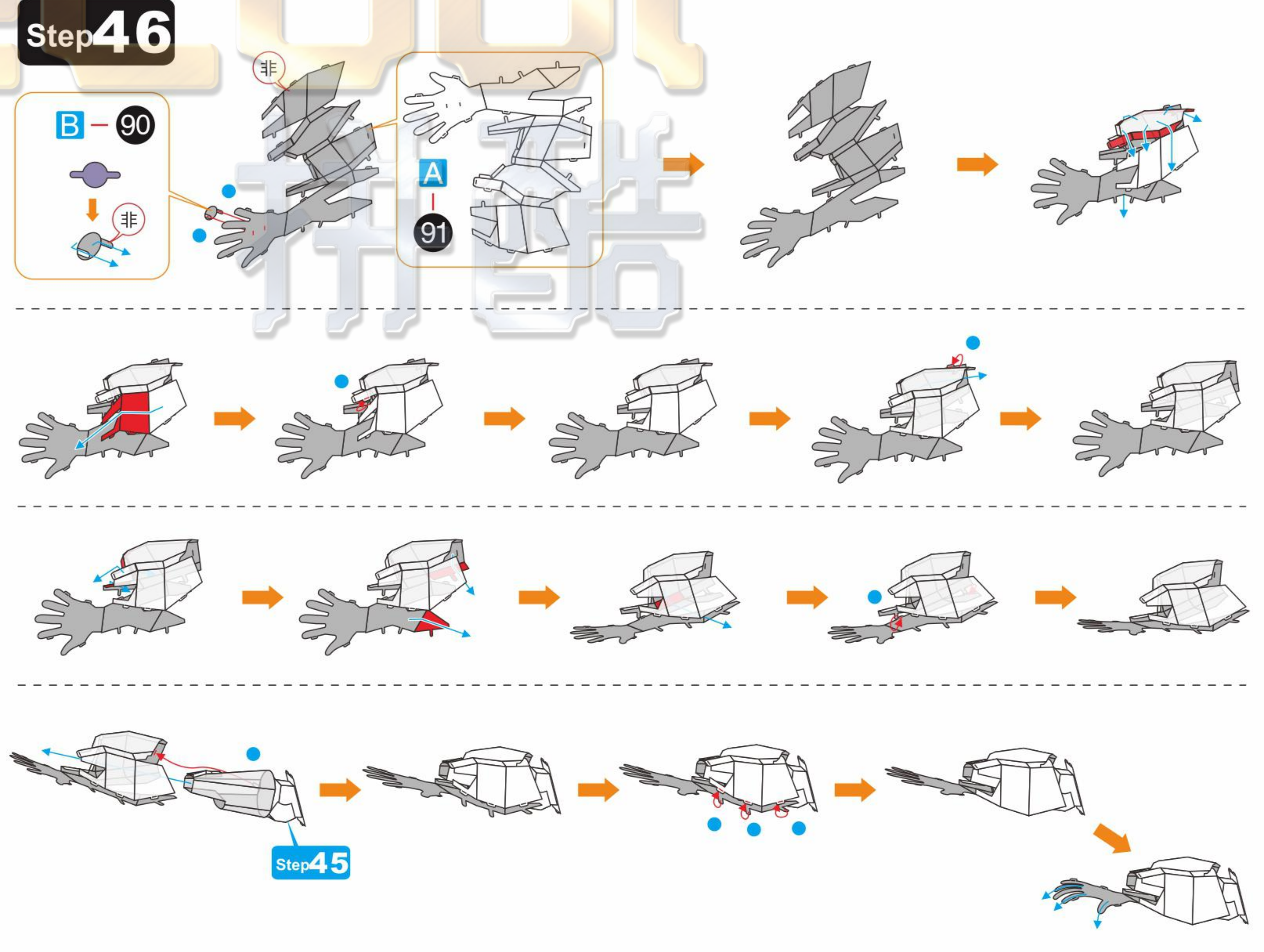

Step50

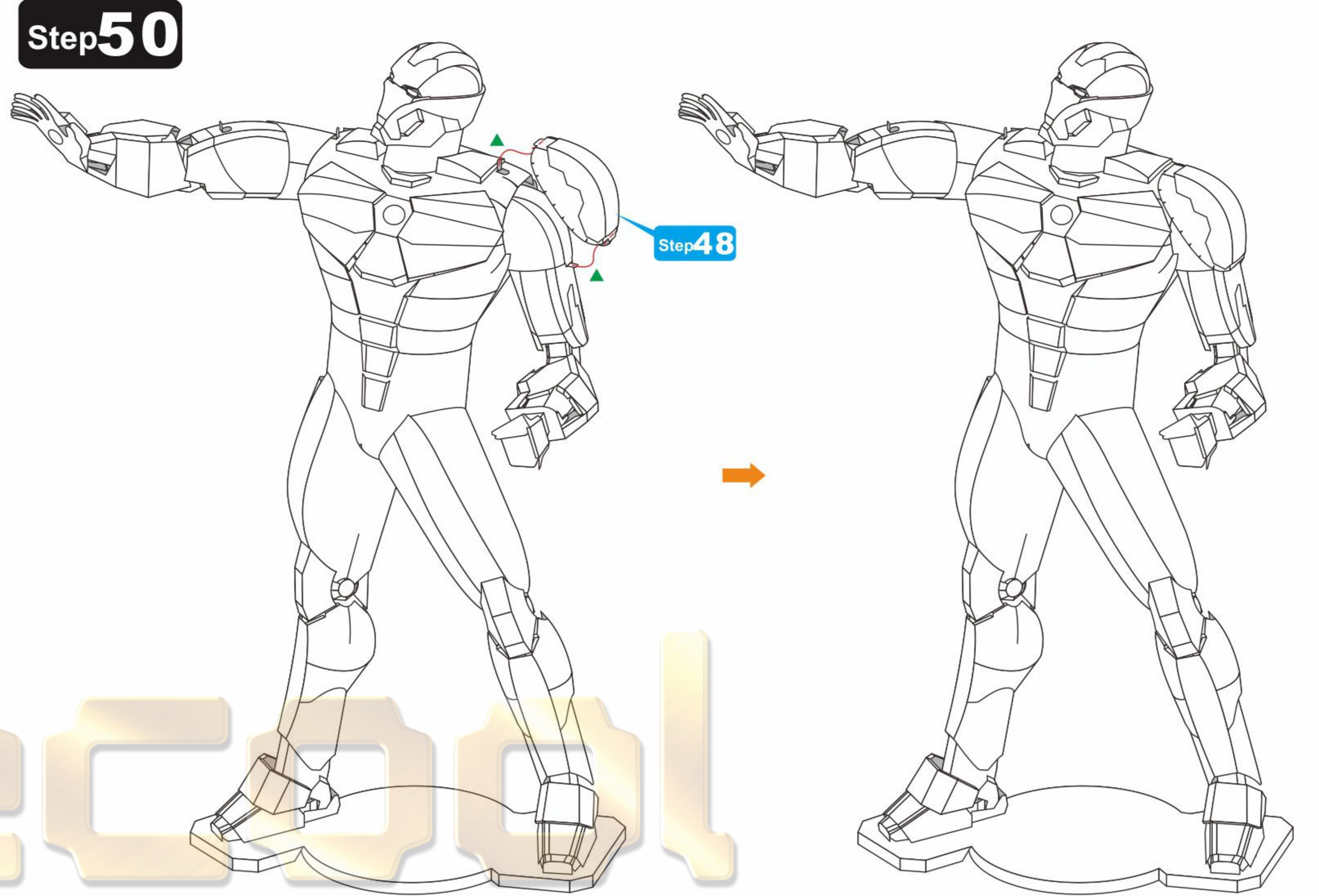

Step49

