



聚远楼
JUYUAN TOWER
P111

拼装说明书



AGES 14+

本产品为金属制品，14岁以下需由成人陪同完成！

© WIST PLASTIC & METAL TECHNOLOGY LIMITED. ALL RIGHTS RESERVED.

电子版下载地址: <http://www.pieceecool.com/cpshuoming/P111.pdf>

拼前需知



● 准备工具：



建议使用拼酷正品拼装工具（水口钳、尖嘴钳），拼装时更省心、省力，拼装后作品更精细、美观！

● 拼装方法：

a. 取下零件



使用水口钳剪断金属零件上的水口，将需要的金属零件从金属片板件取下。

b. 识别零件



识别金属零件上的扣点、折叠线、扣孔的样子。

c. 折叠零件

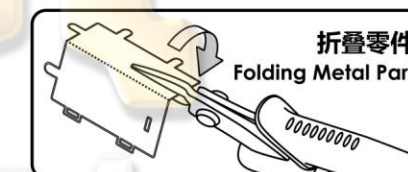

使用尖嘴钳，参照拼装说明书将金属零件折成形状。

d. 固定零件

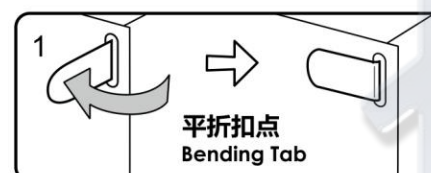

● 插入扣孔，平折 90°

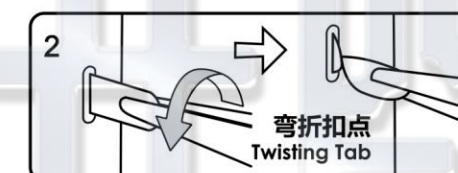

▲ 插入扣孔，旋转 90°

● 注意事项：



剪金属零件时请剪零件“水口位”，请勿将“扣点”当成“水口位”剪下，每次剪零件时请仅剪当前步骤的零件，切勿一次性将所有零件全部剪下，避免丢失；

当遇到折叠线的零件，请注意金属片的正反面及拼折方向，请按照说明书说明的方向，轻剪慢折，最好一次折叠完成，请勿反复折叠，避免零件损坏。

拼装步骤



Step 01

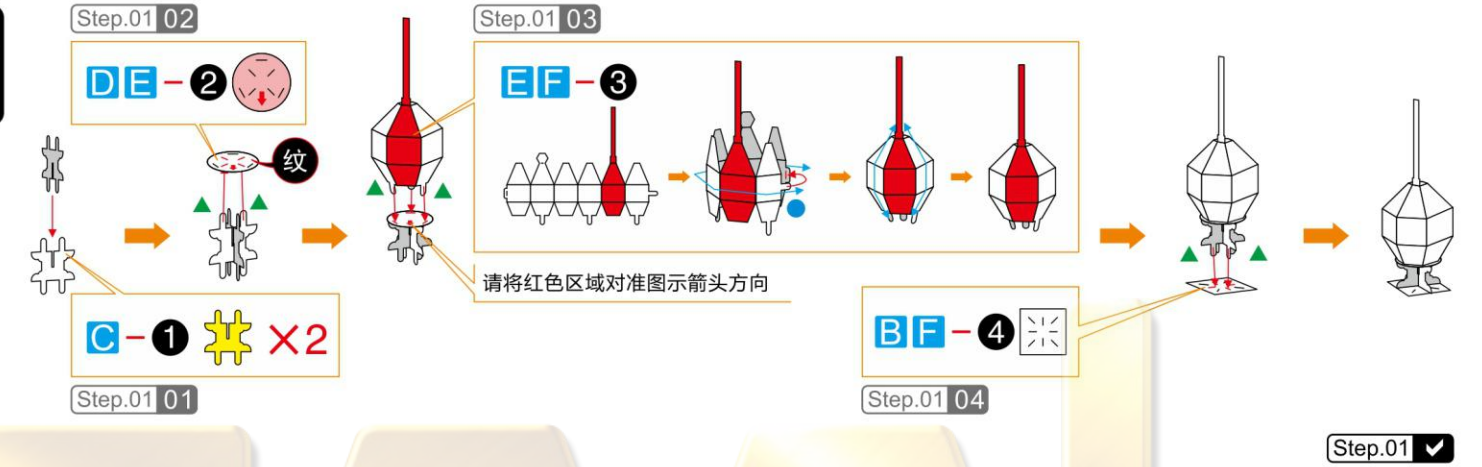

Step 02

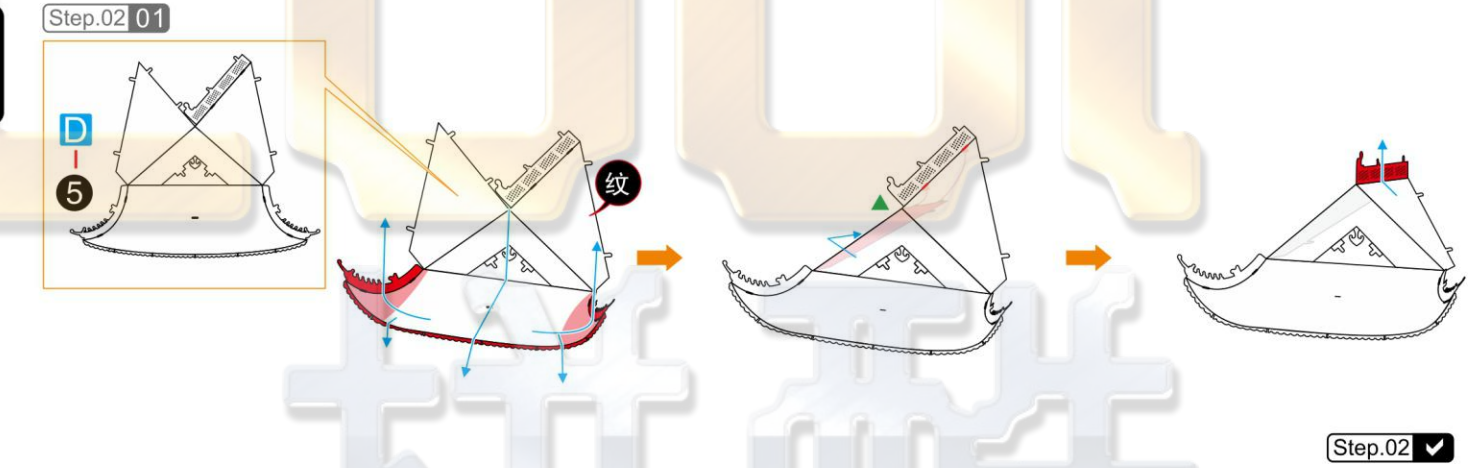

Step 03

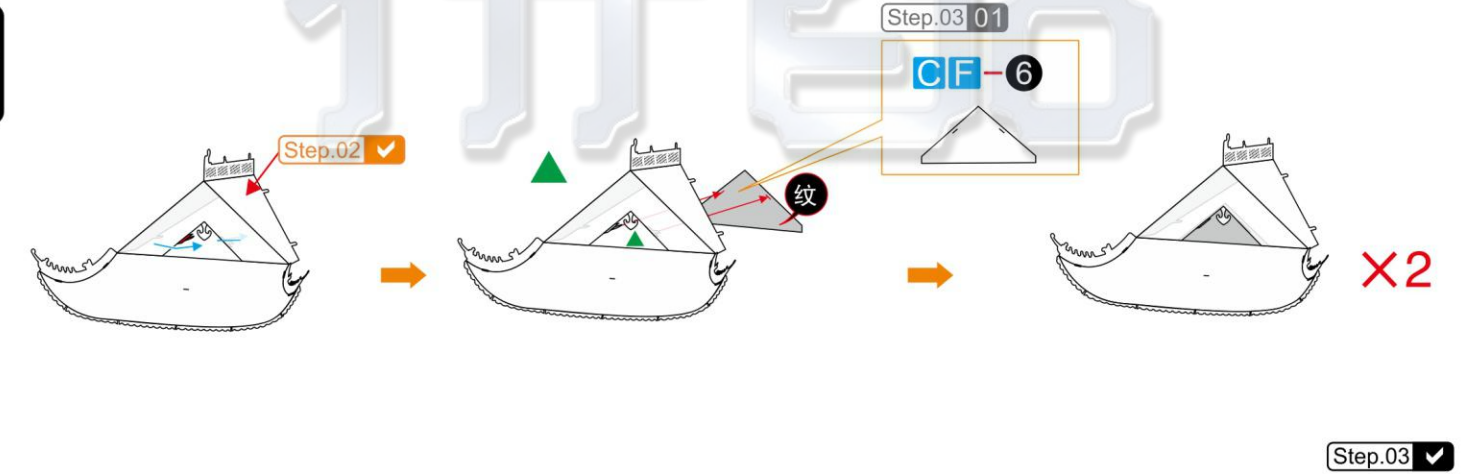

Step
04

Step.04 01

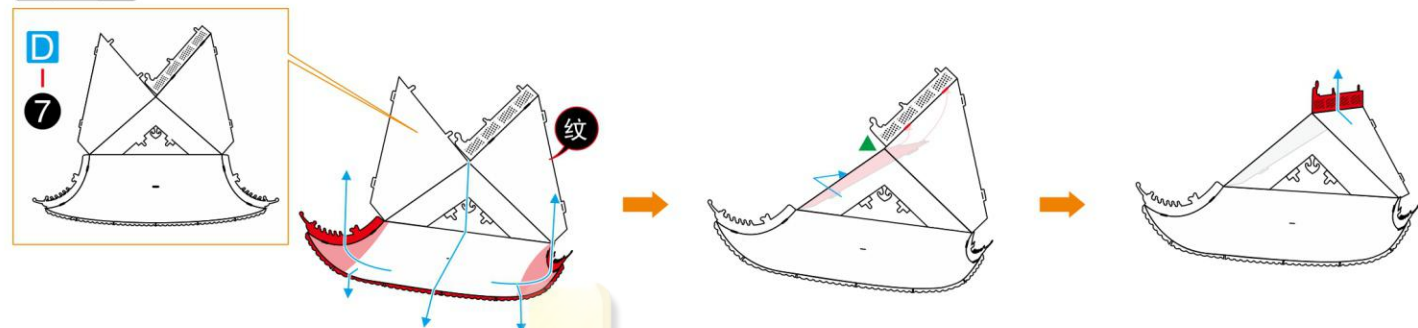

Step.04 ✓

Step
05

Step.05 01

CF-6

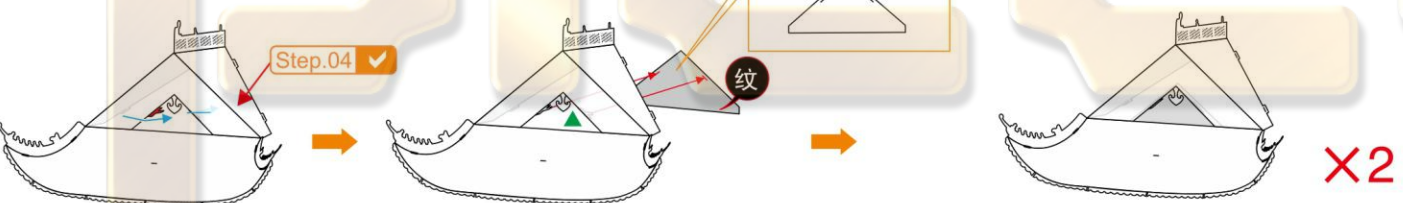

Step.05 ✓

Step
06

Step.06 01

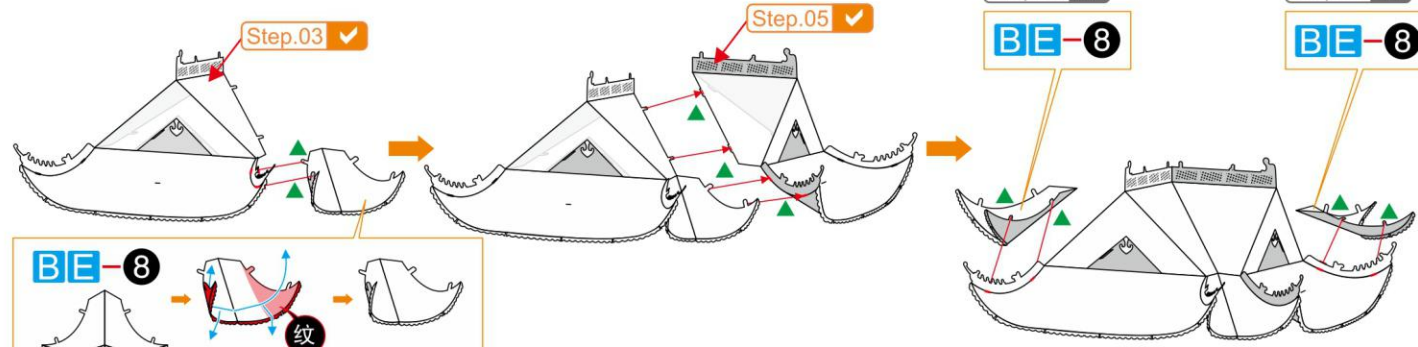

Step.06 ✓

Step
07

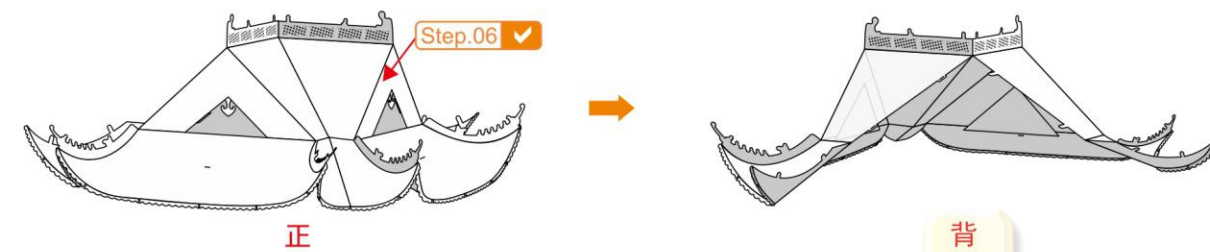

Step.07 ✓

Step
08

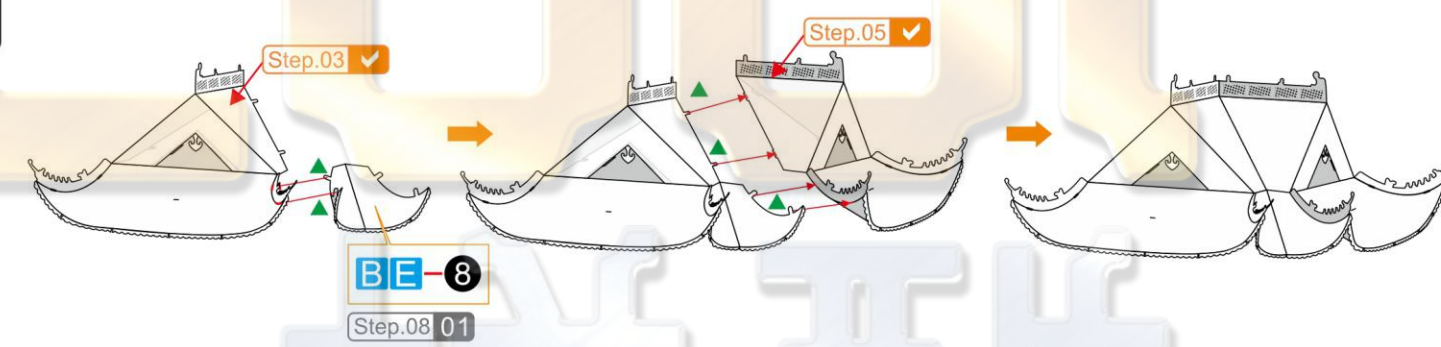

Step.08 ✓

Step
09

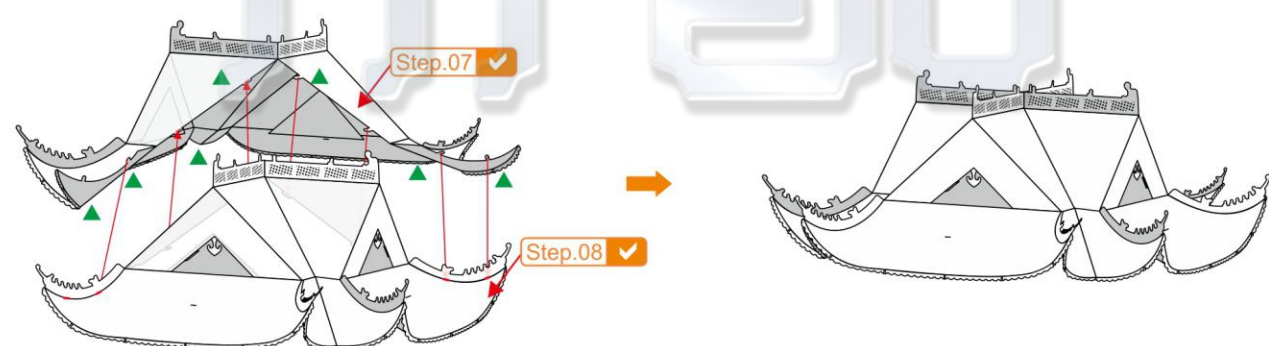

Step.09 ✓

Step 10

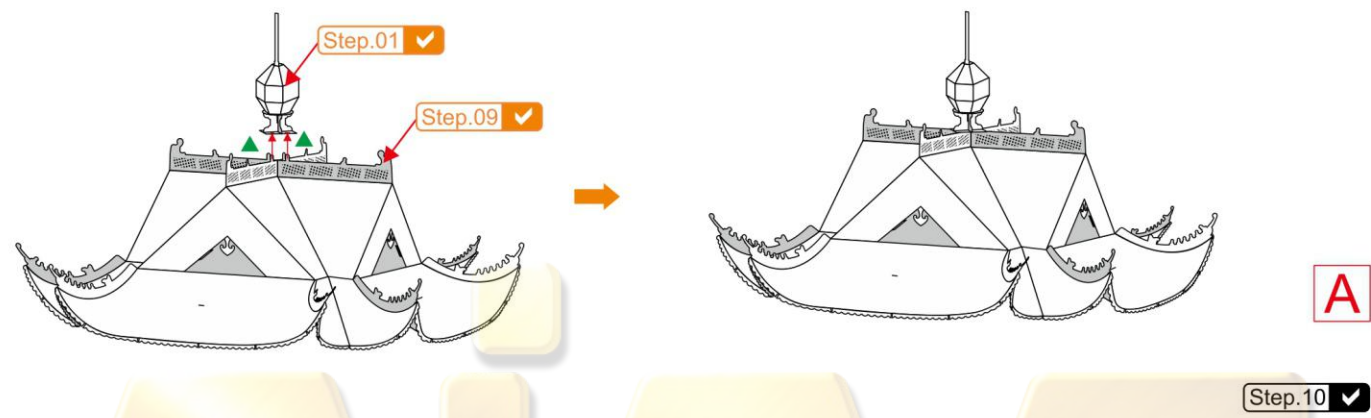

Step 11

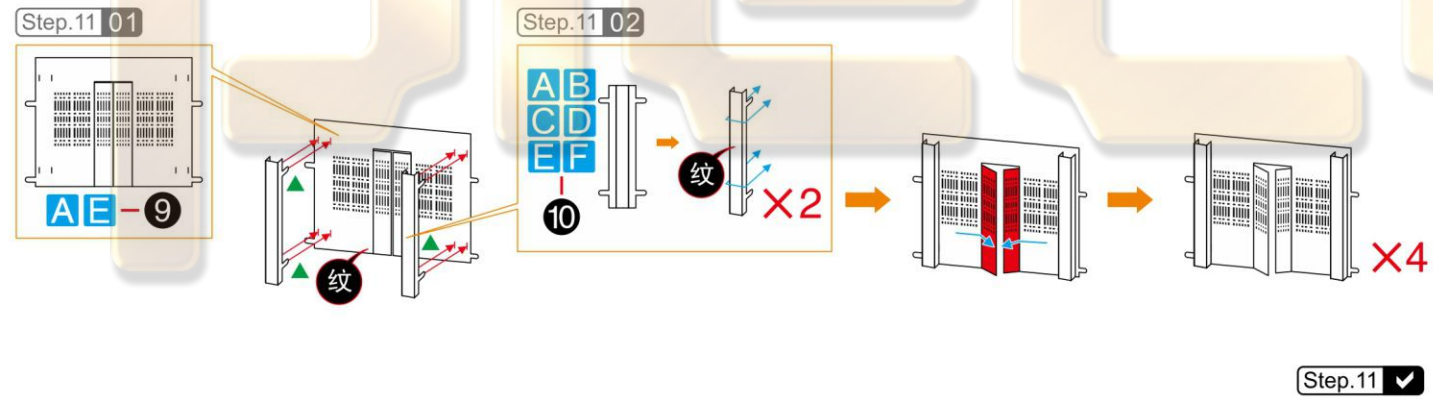

Step 12

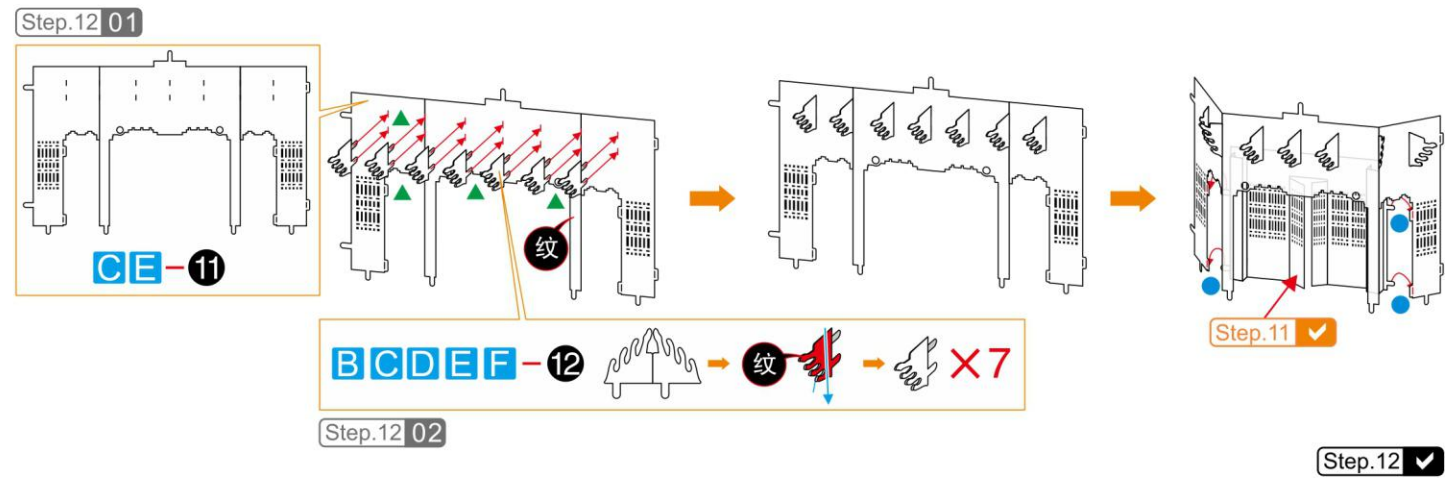

Step 13

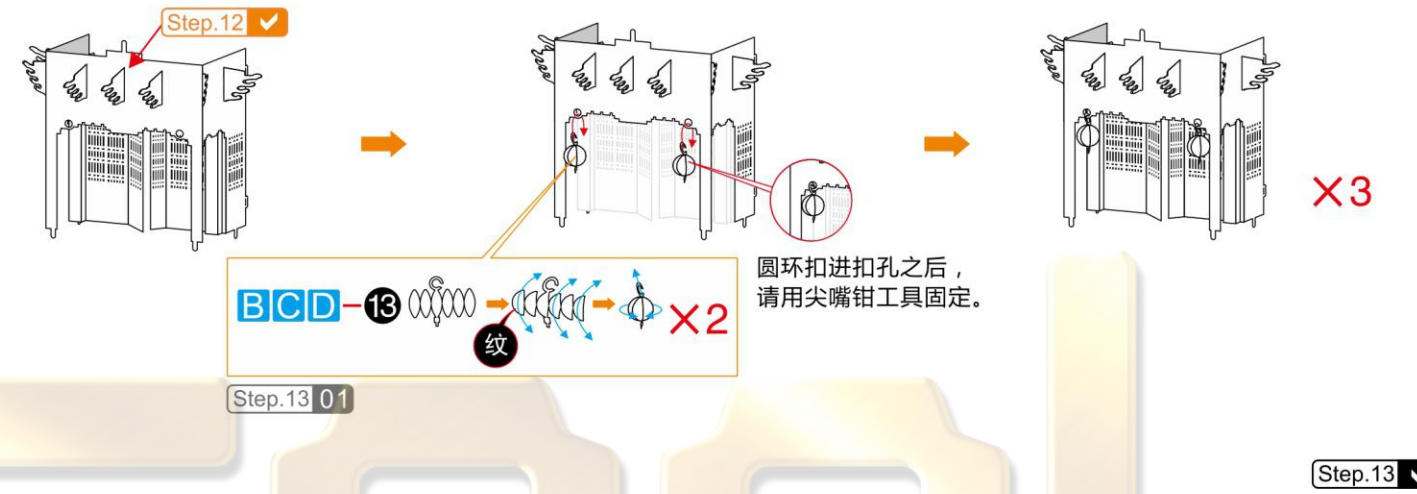

Step 14

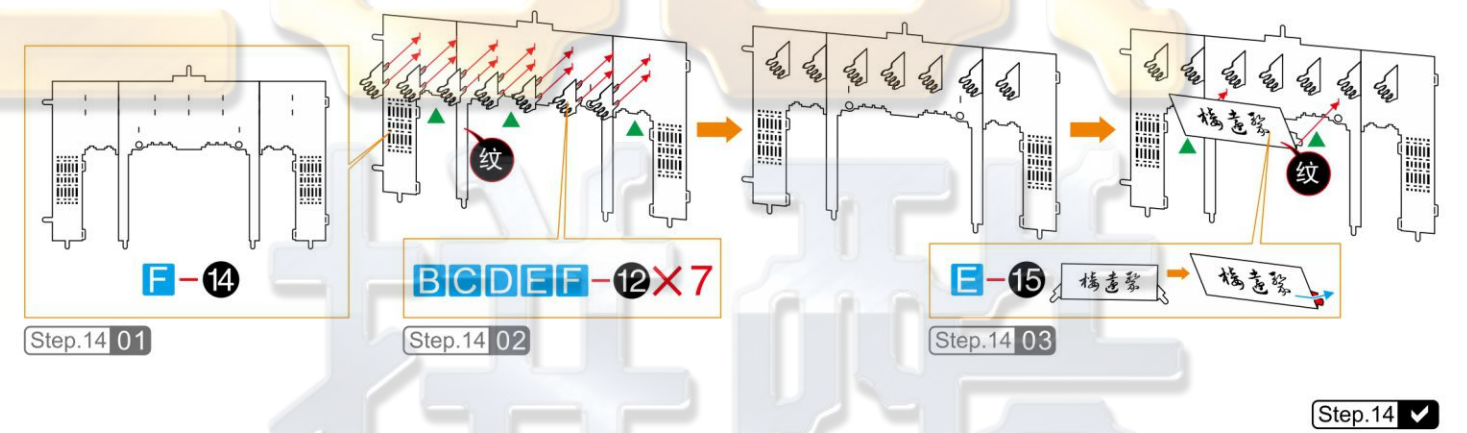

Step 15

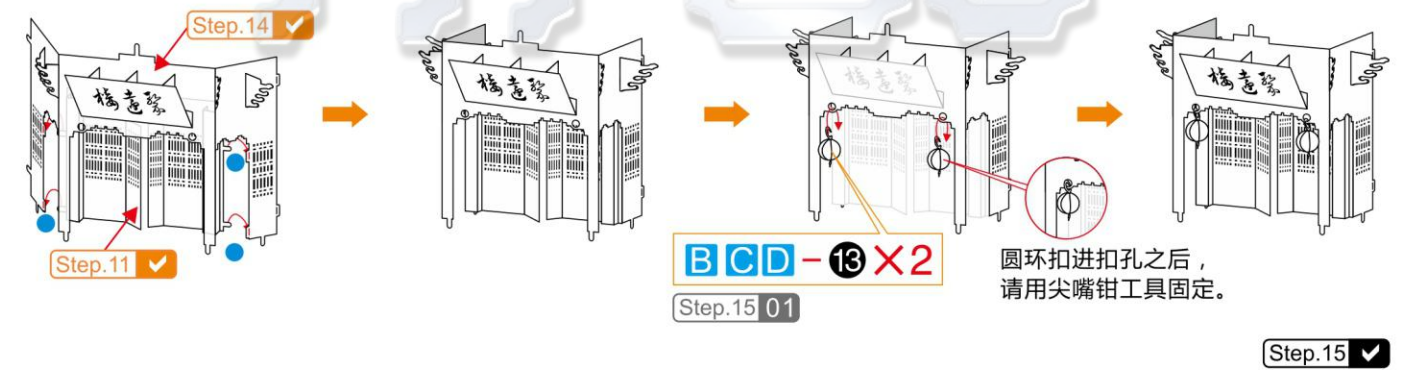

Step 16

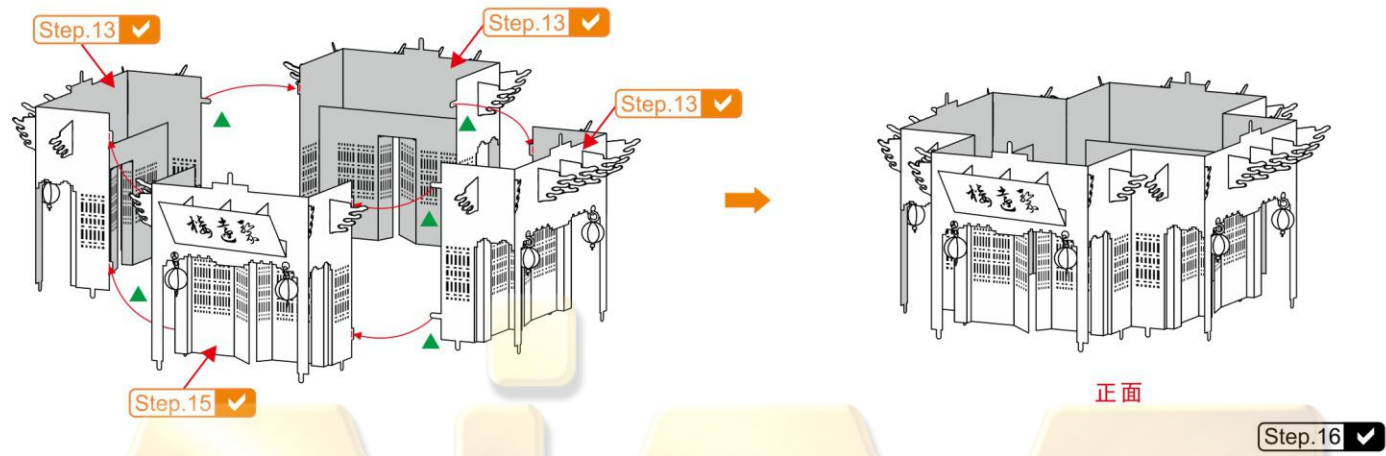

Step 17

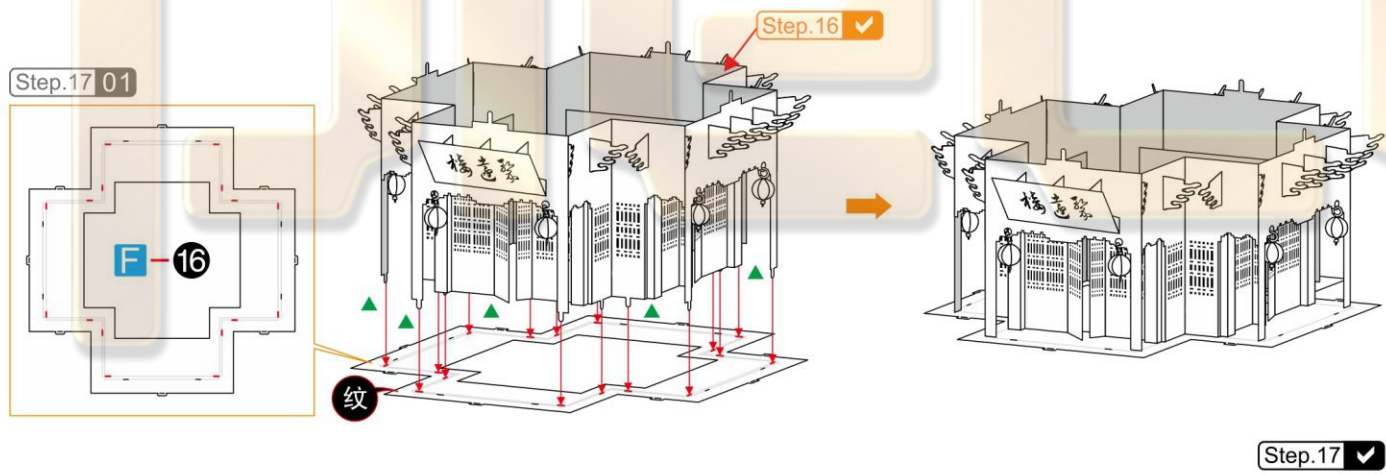

Step 18

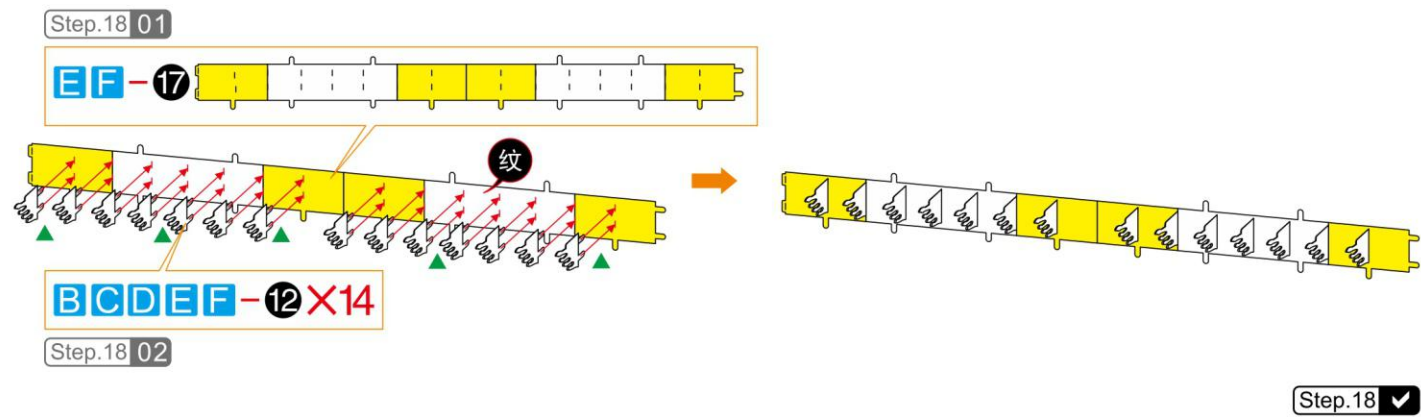

Step 19

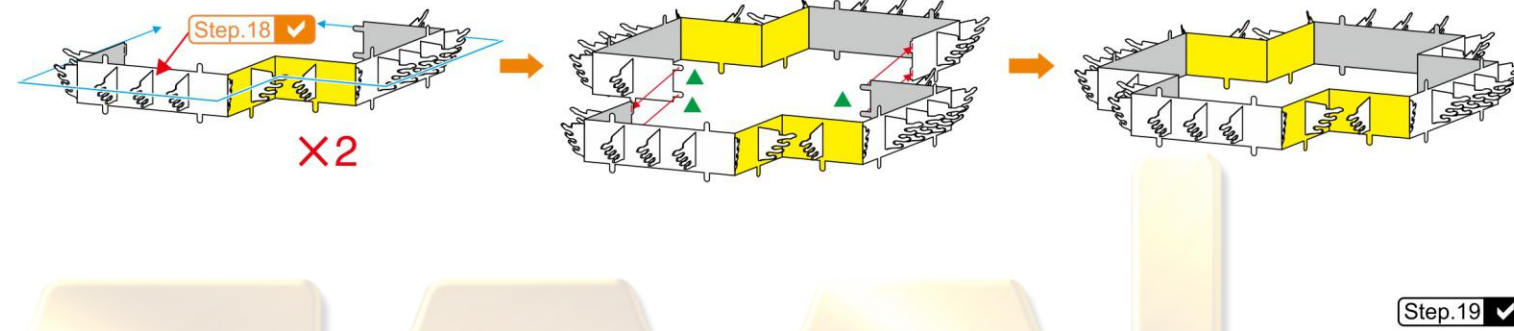

Step 20

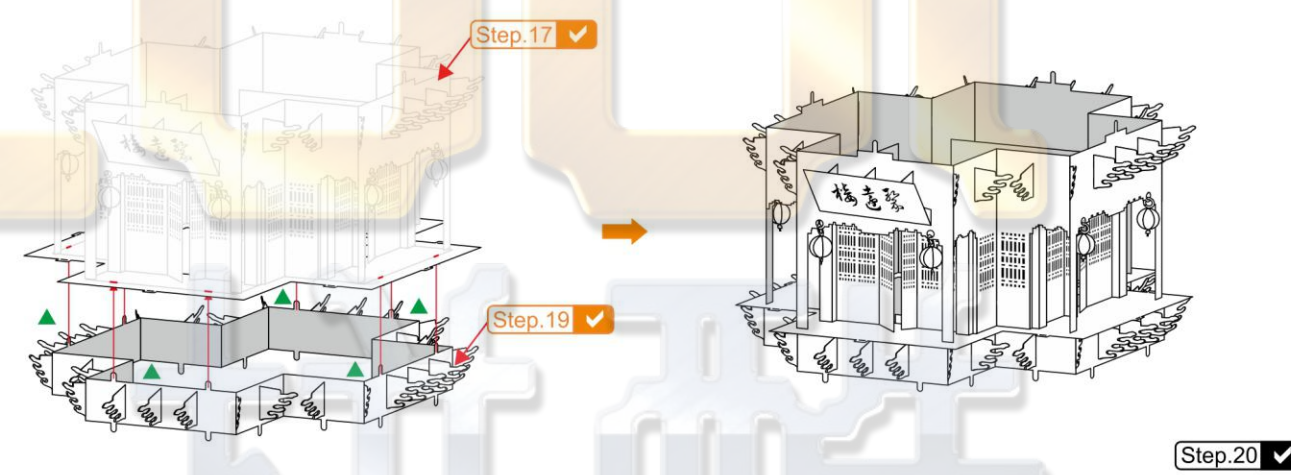

Step 21

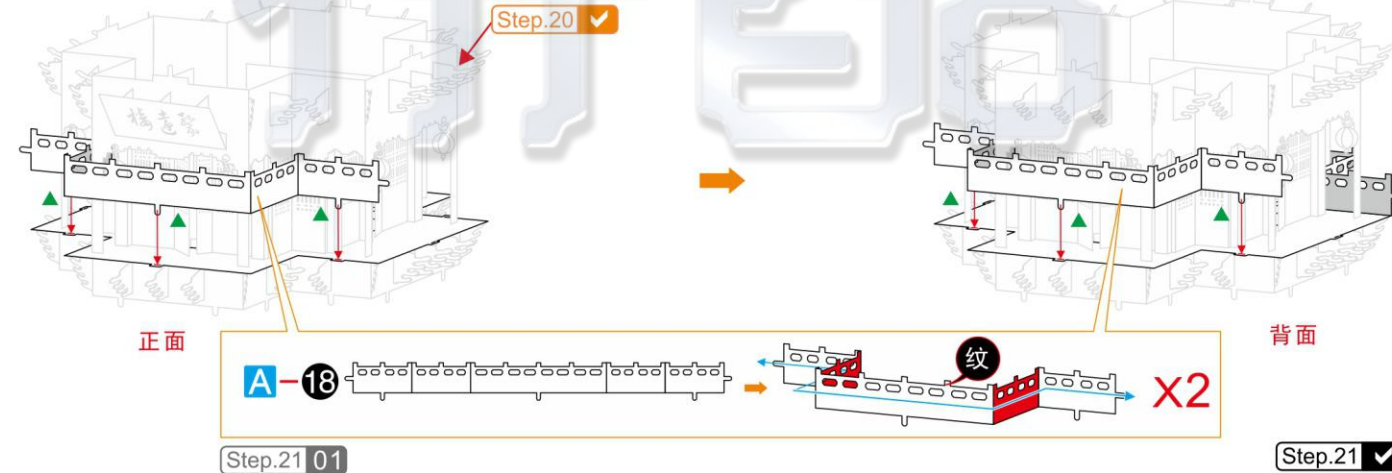

Step 22

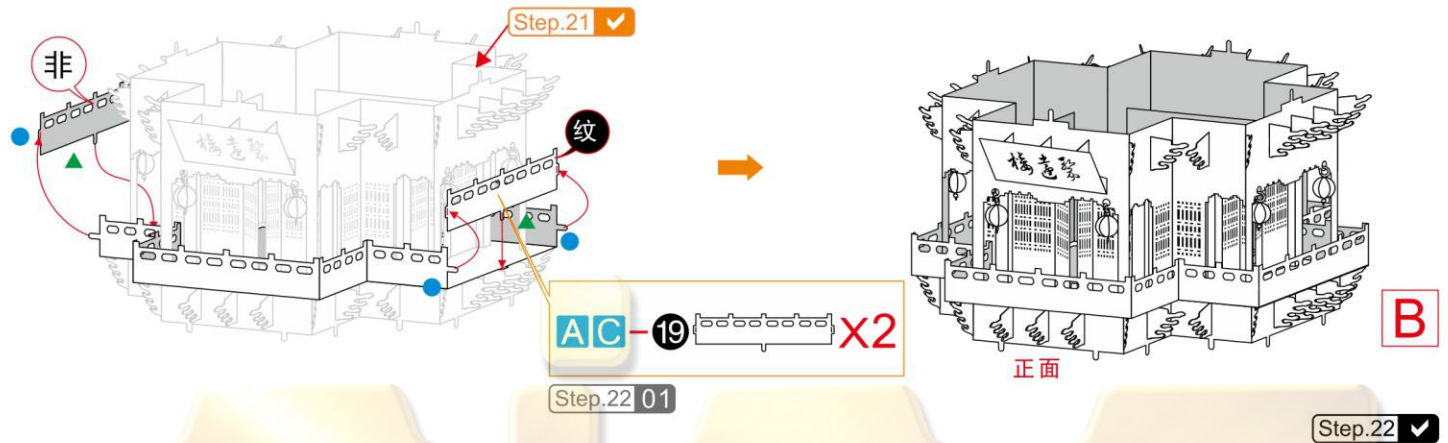

Step 23

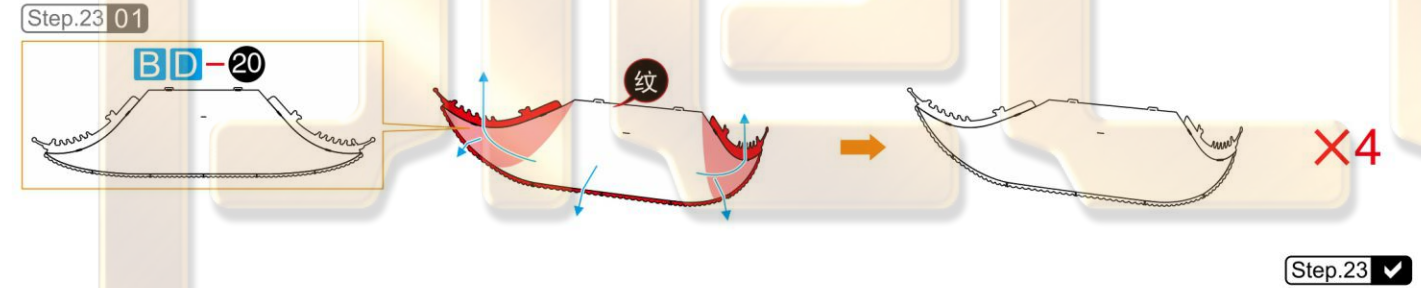

Step 24

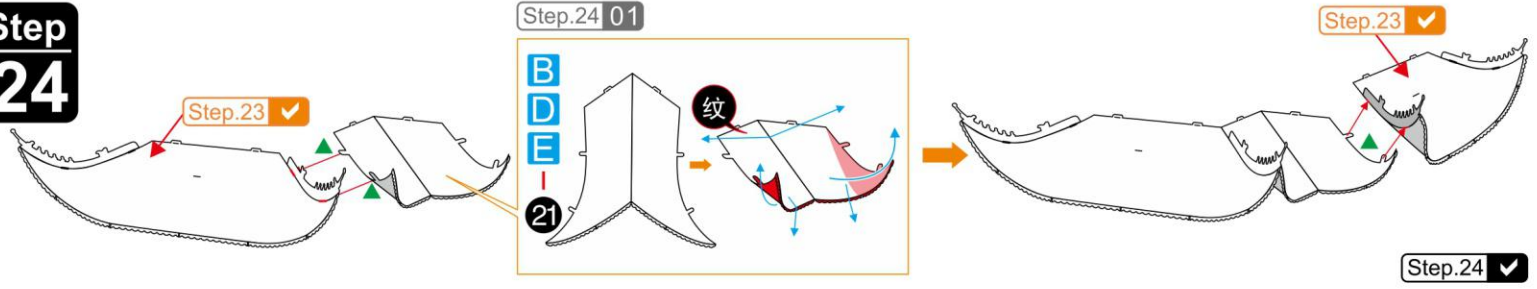

Step 25

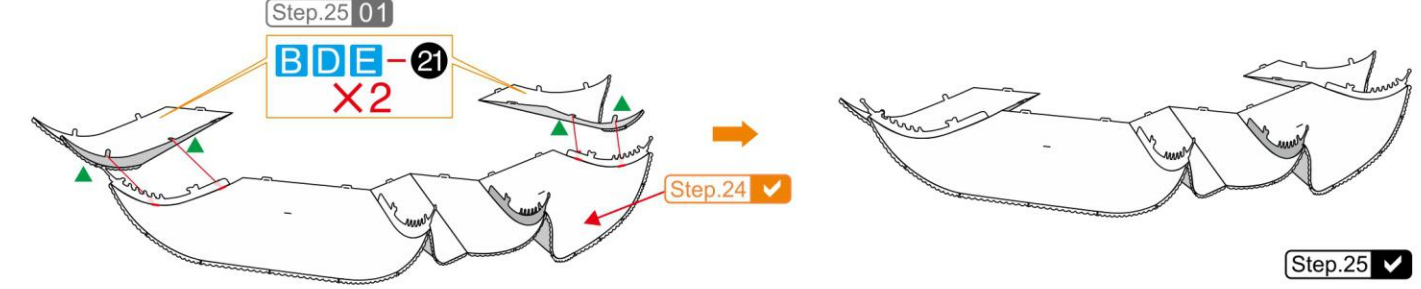

Step 26

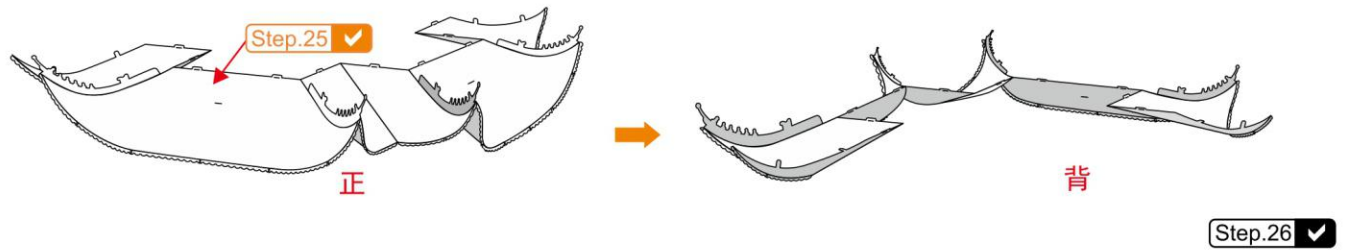

Step 27

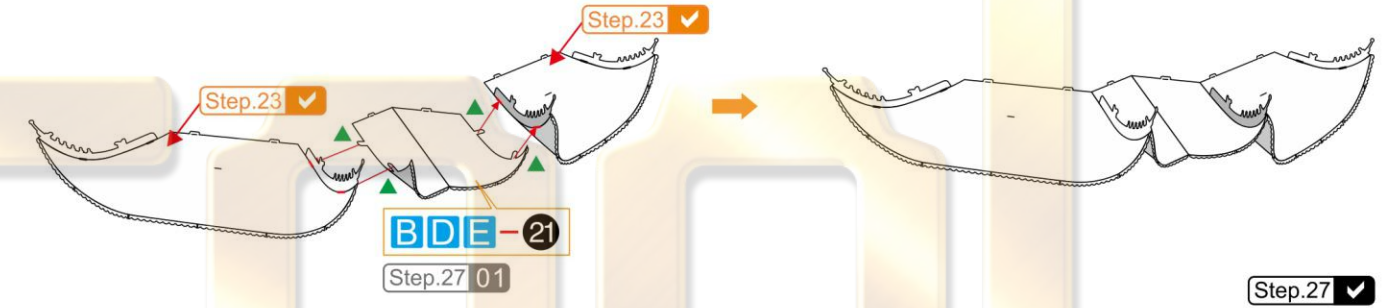

Step 28

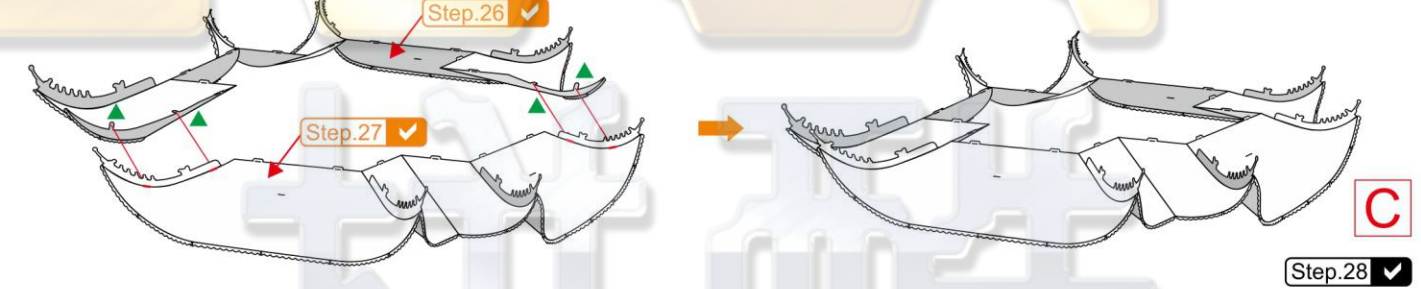

Step 29

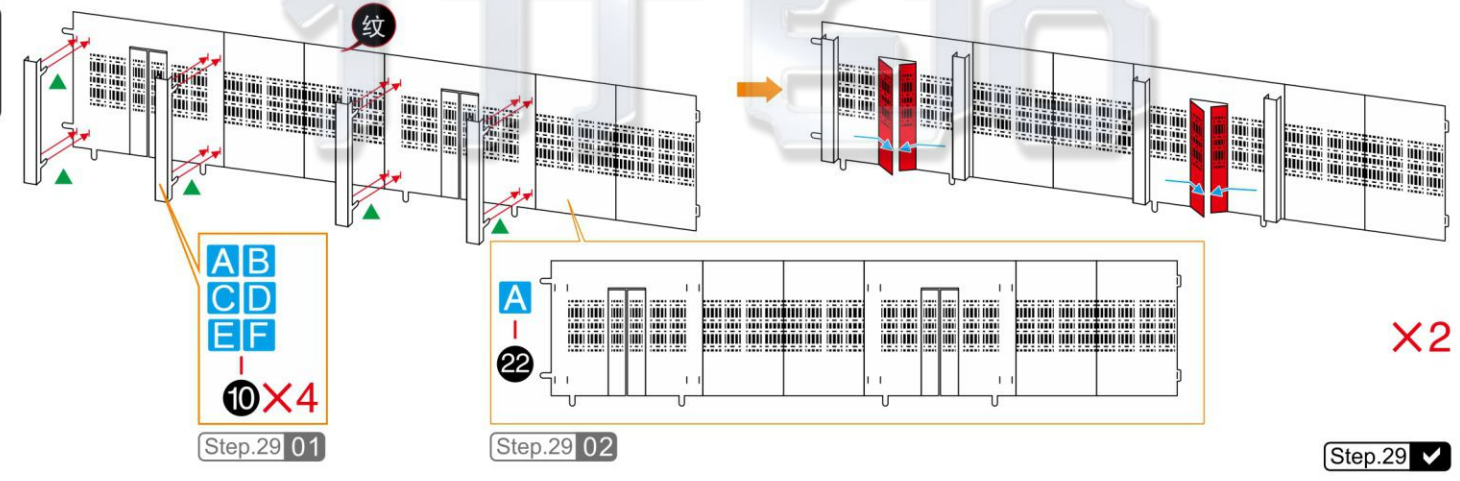

Step 30

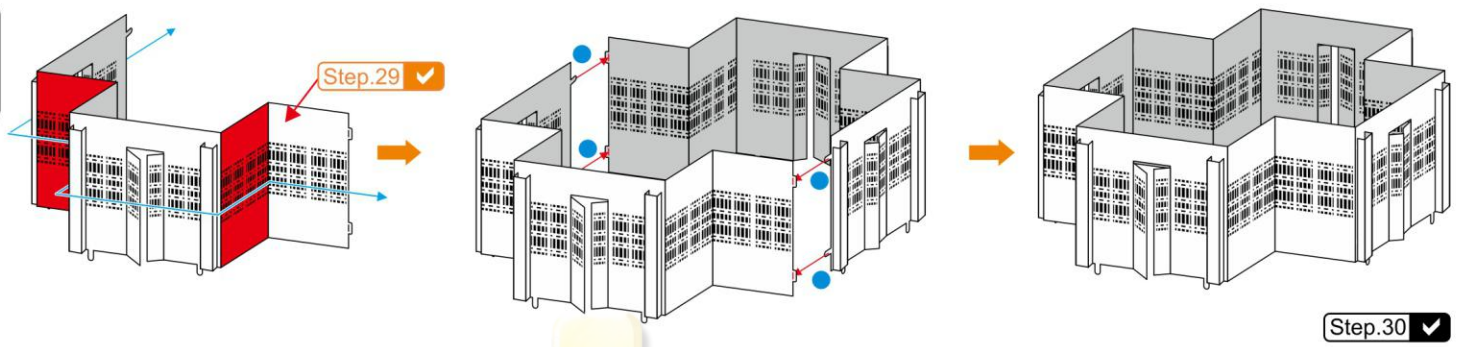

Step 31

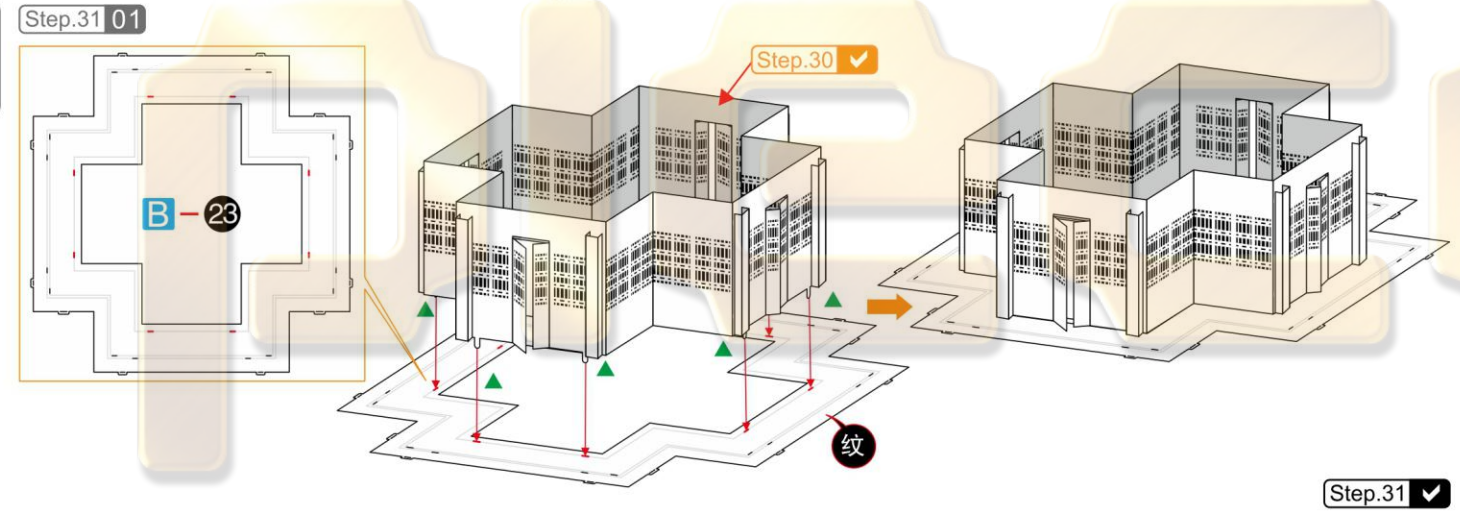

Step 32

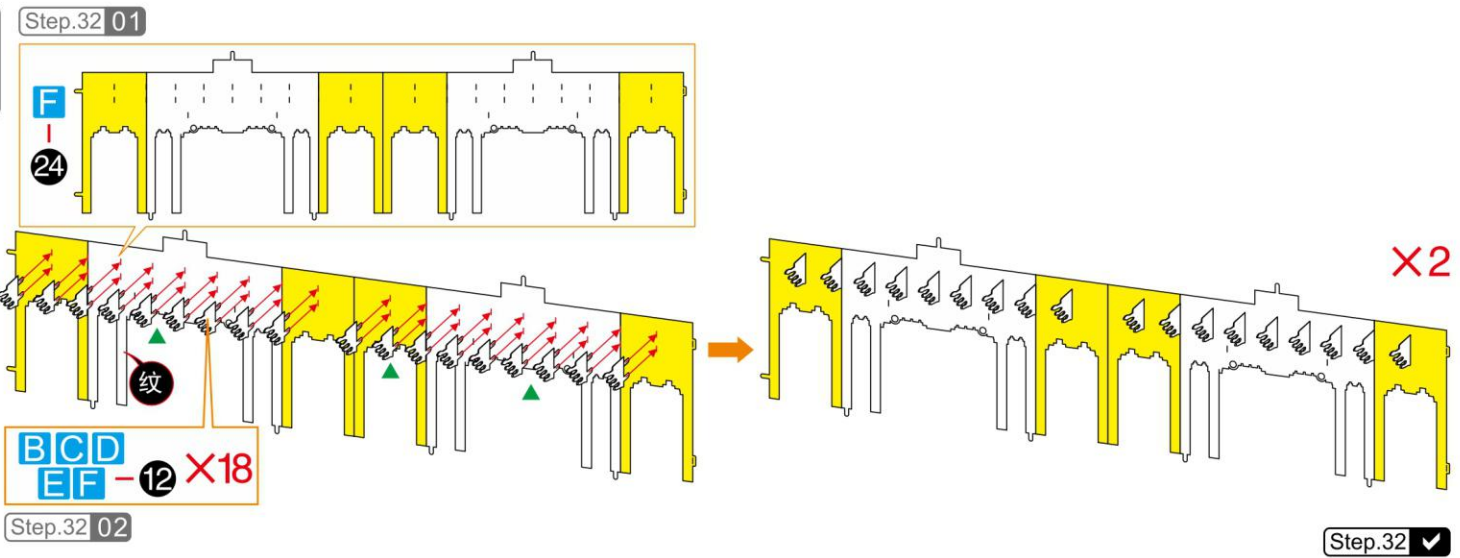

Step 33

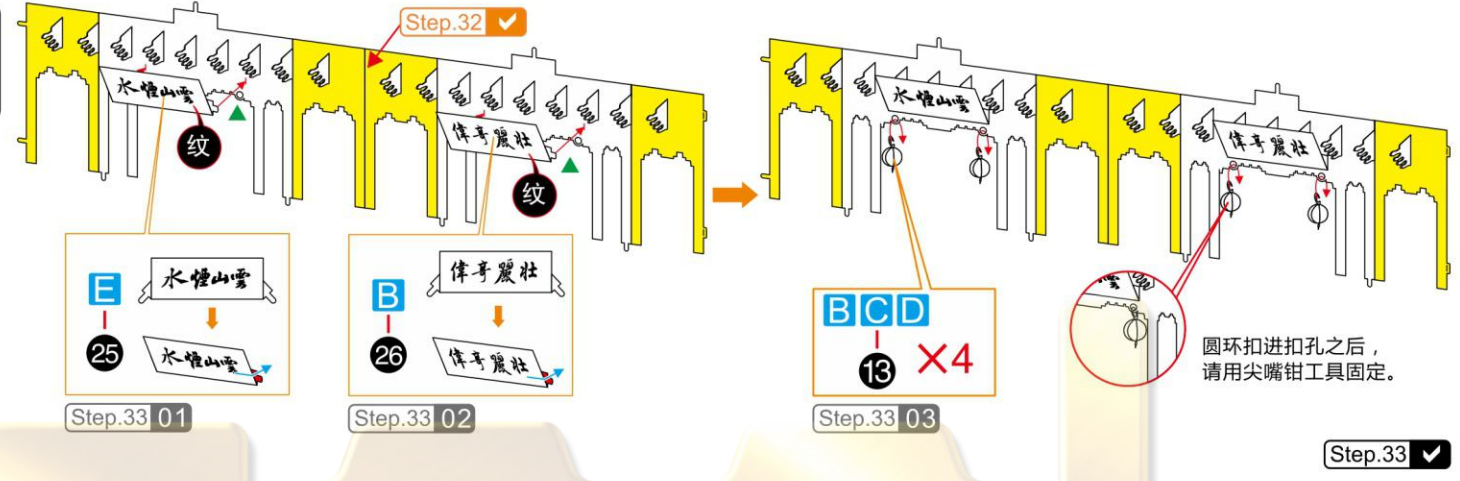

Step 34

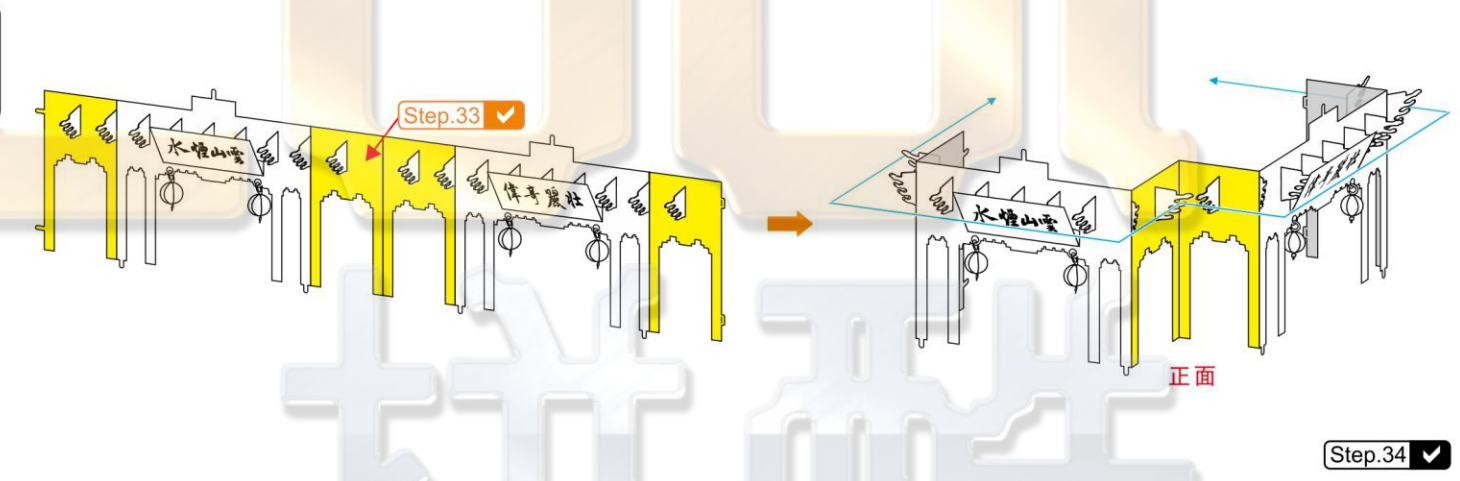

Step 35

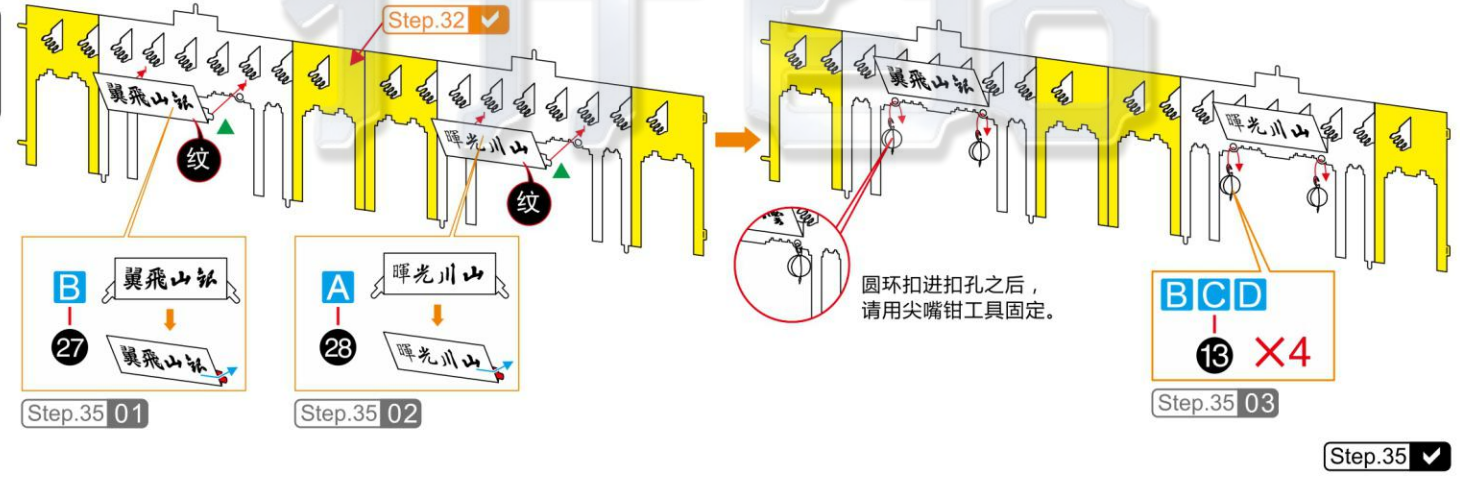

Step 36

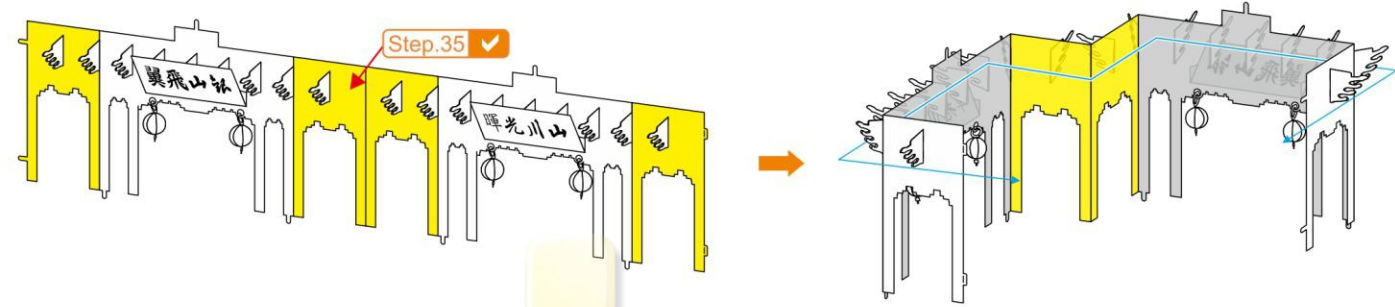

Step.36 ✓

Step 37

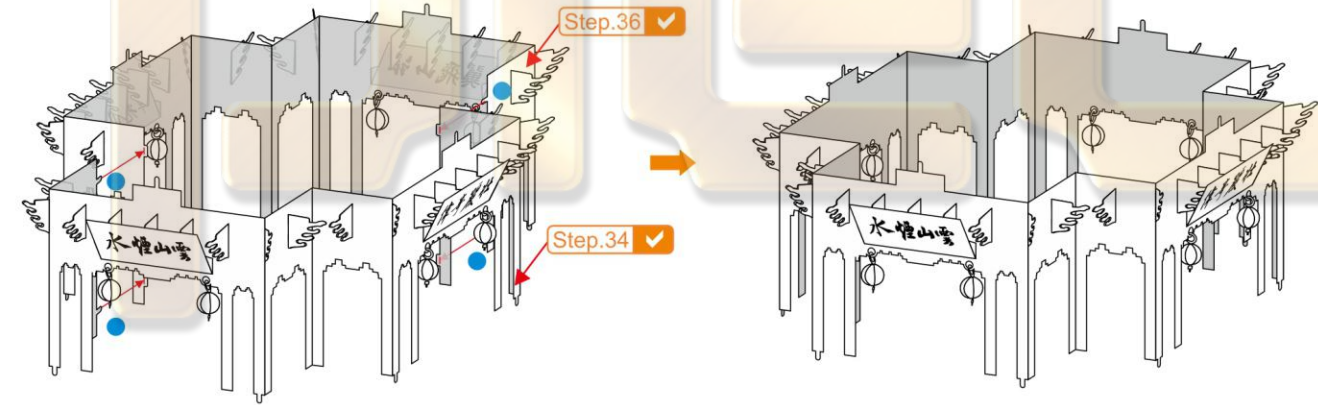

Step.37 ✓

Step 38

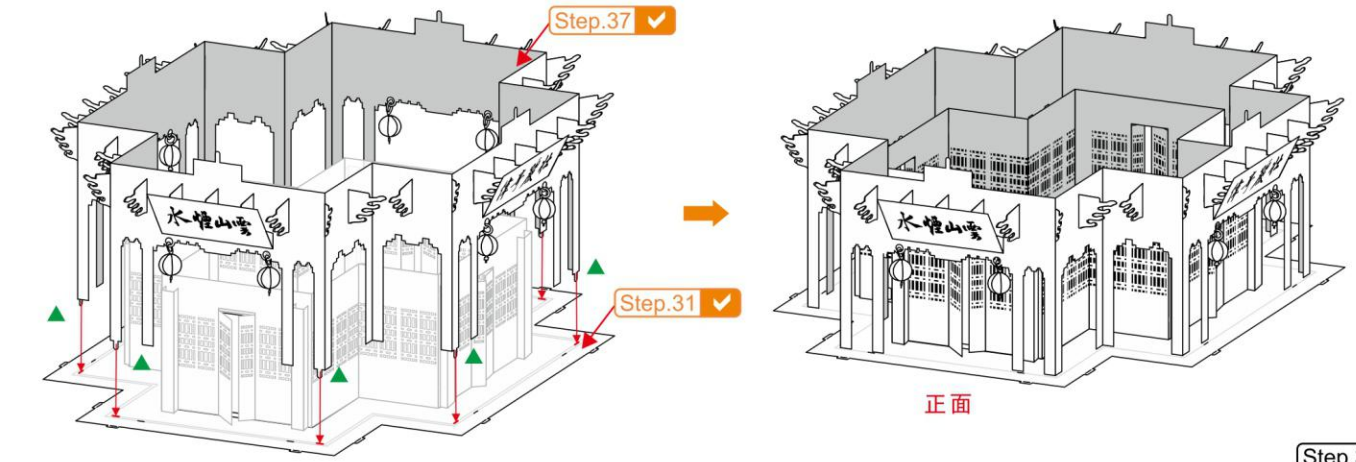

Step.38 ✓

Step 39

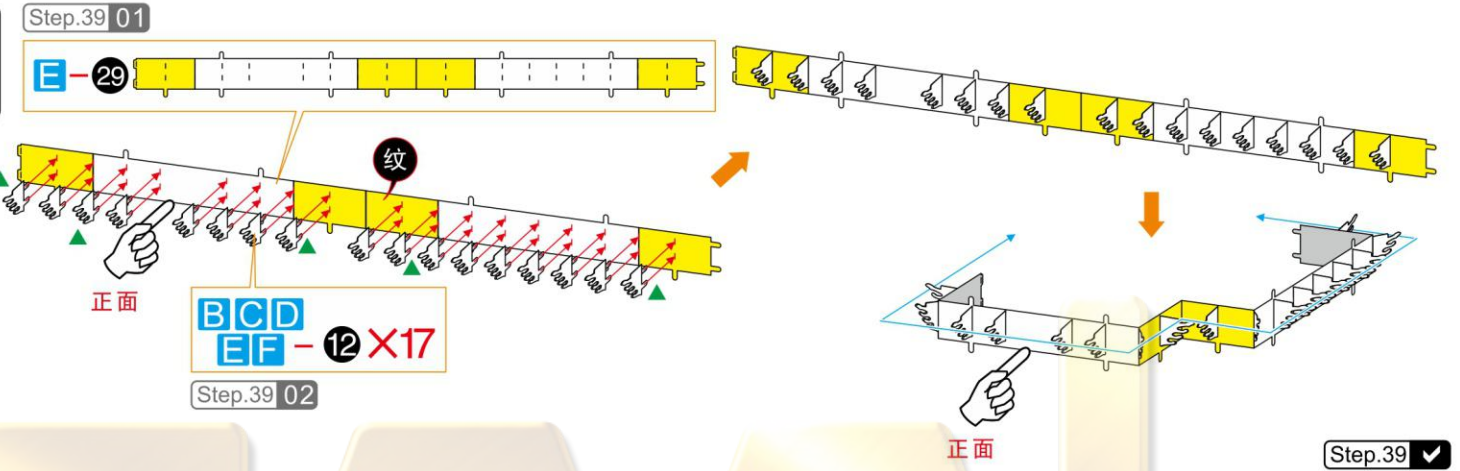

Step.39 ✓

Step 40

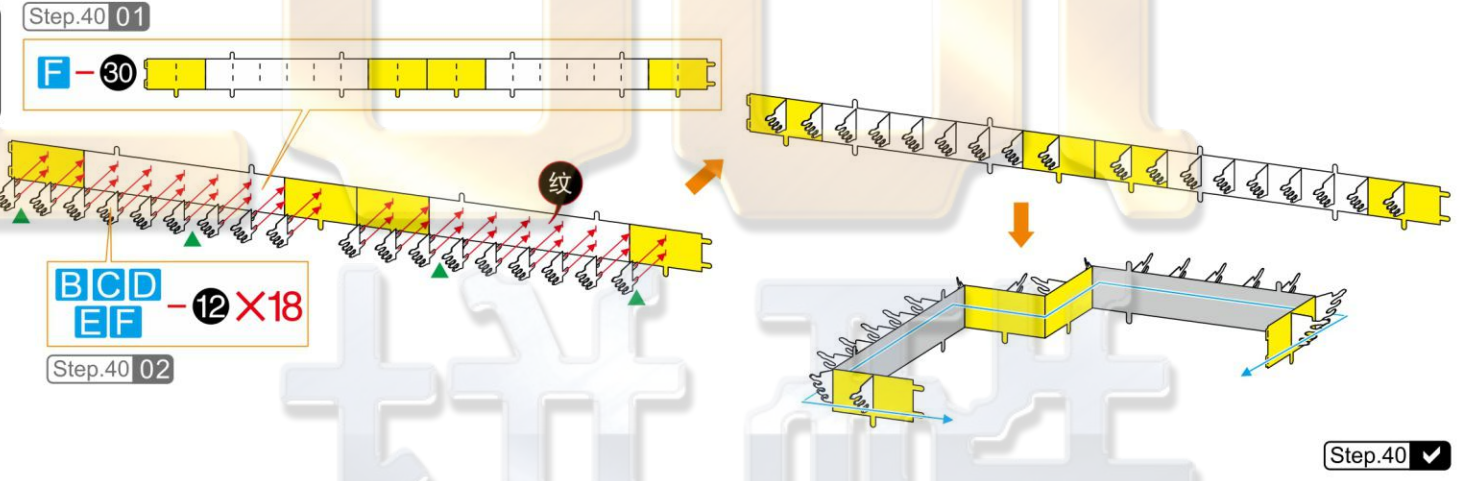

Step.40 ✓

Step 41

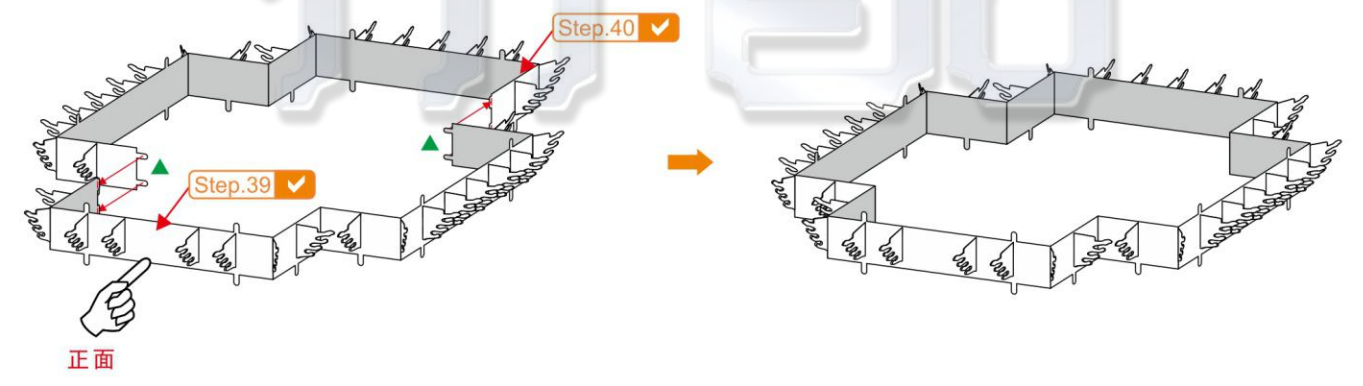

Step.41 ✓

Step 42

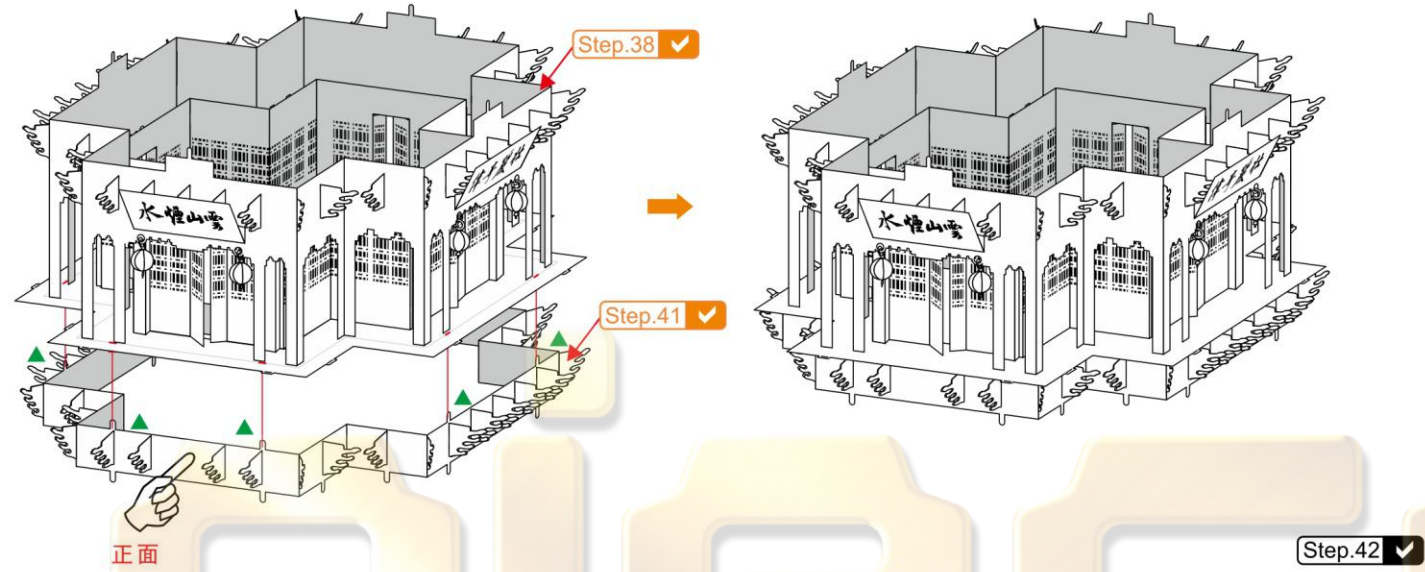

Step 43

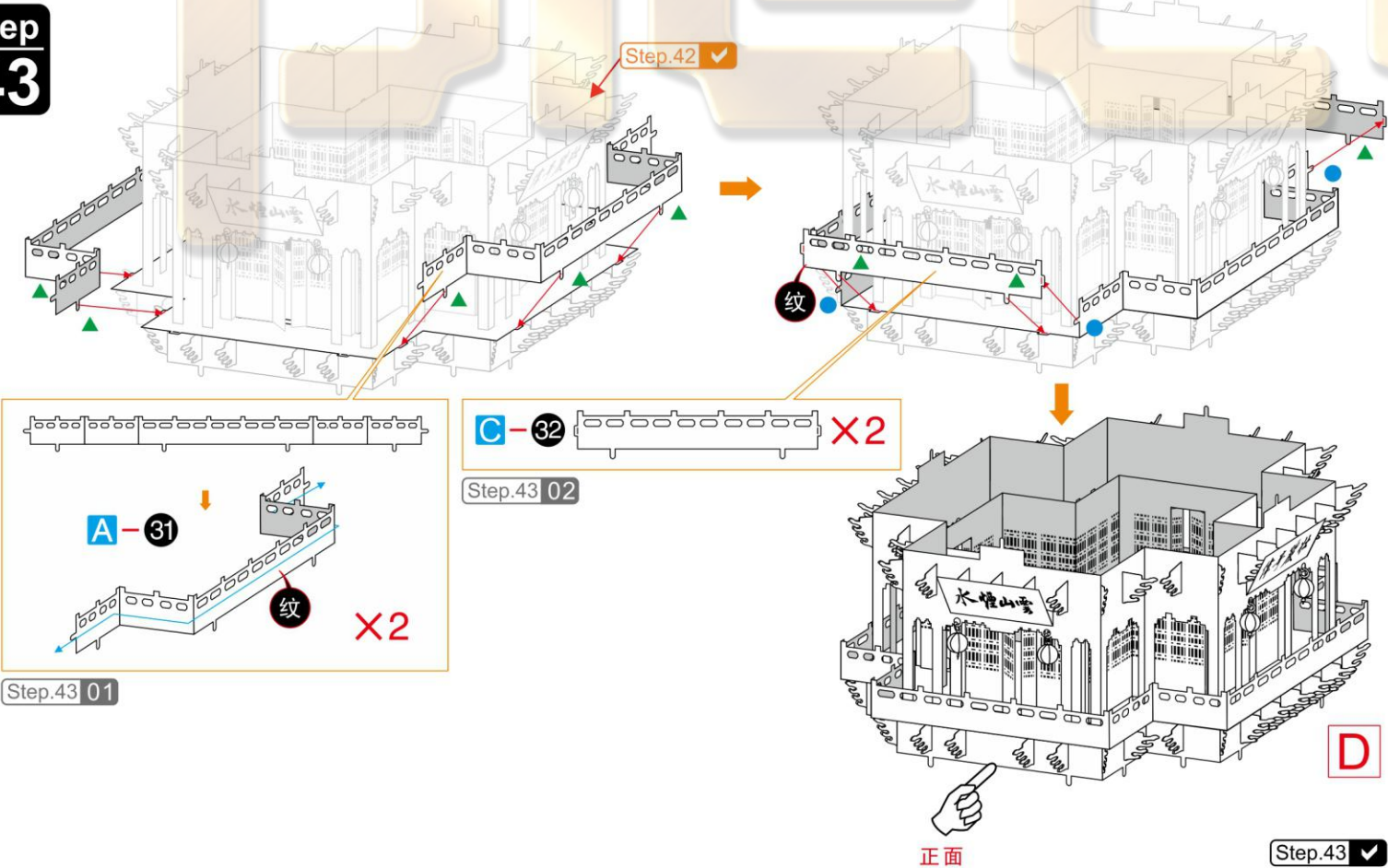

Step 44

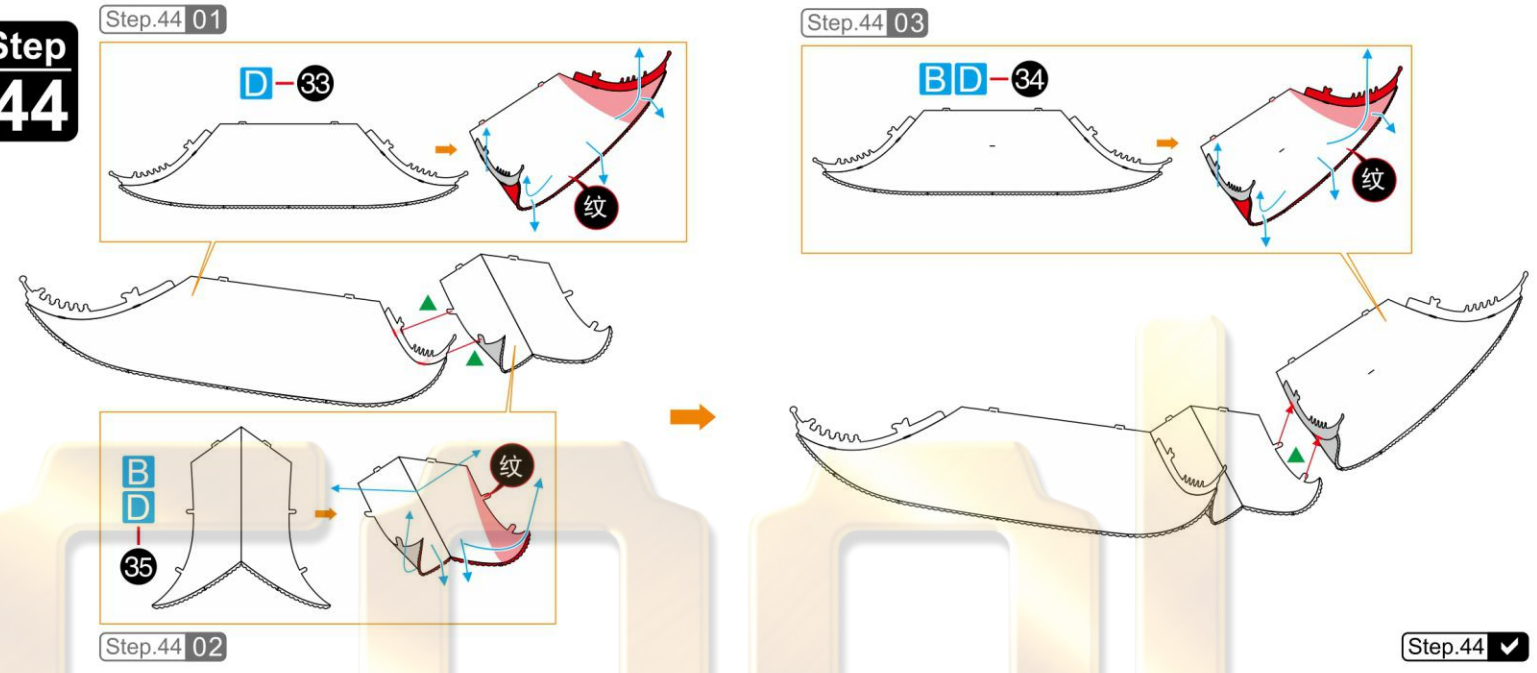

Step 45

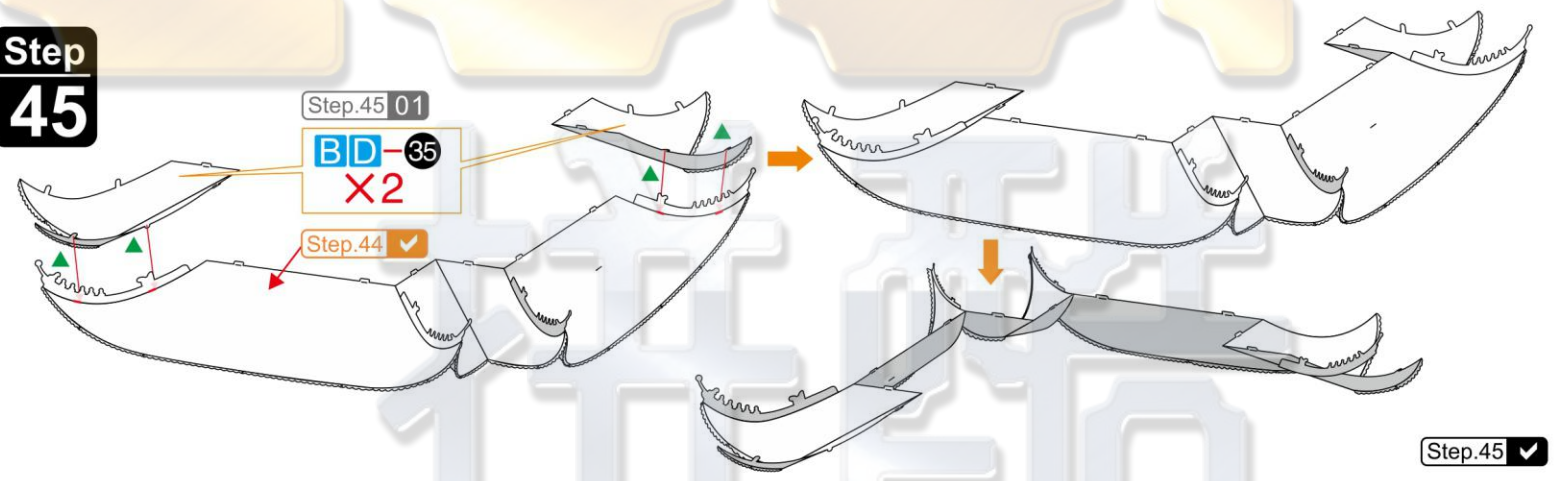

Step 46

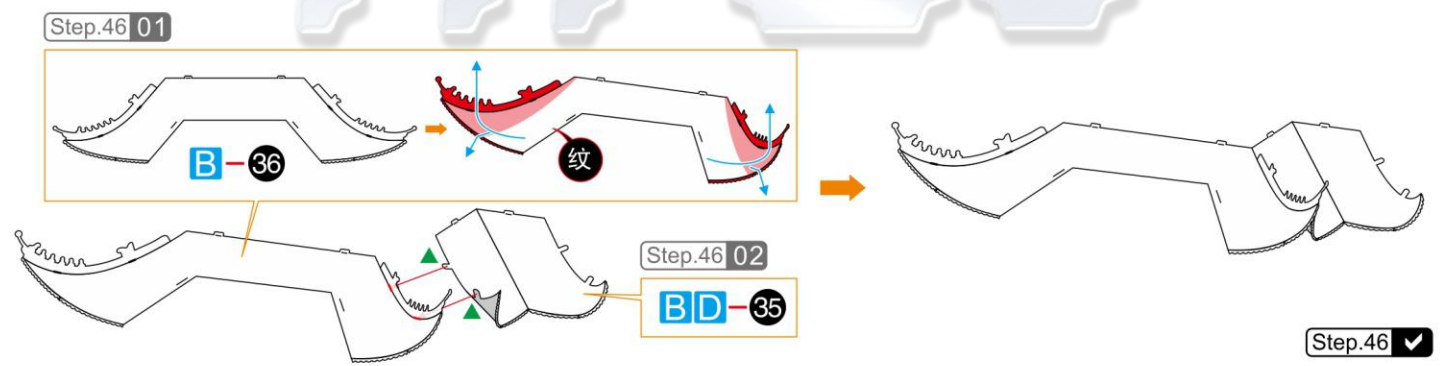

Step
47

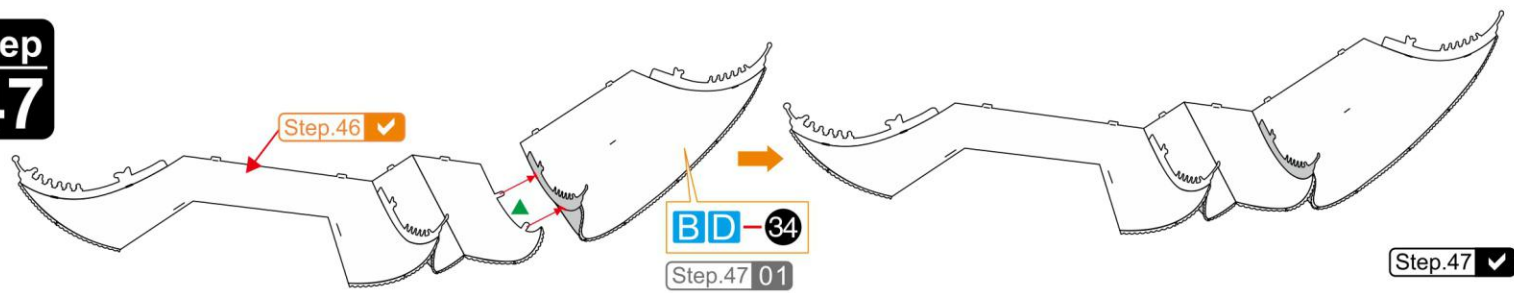

Step
48

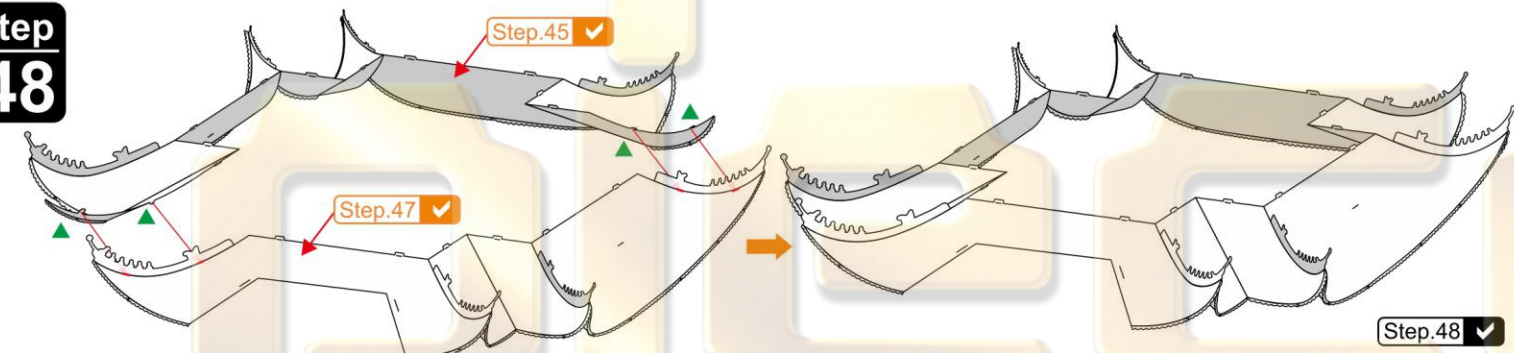

Step
49

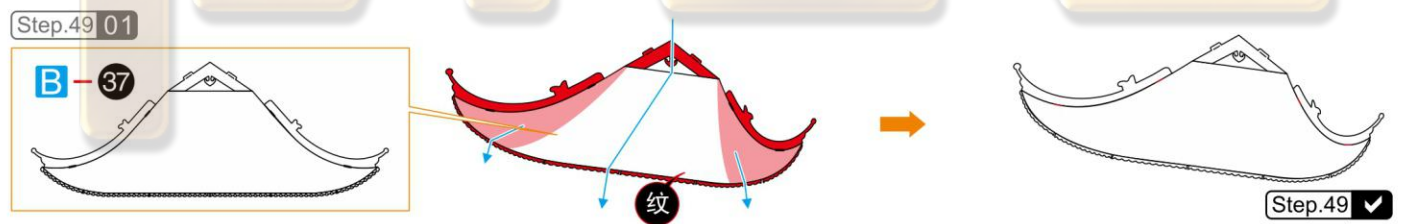

Step
50

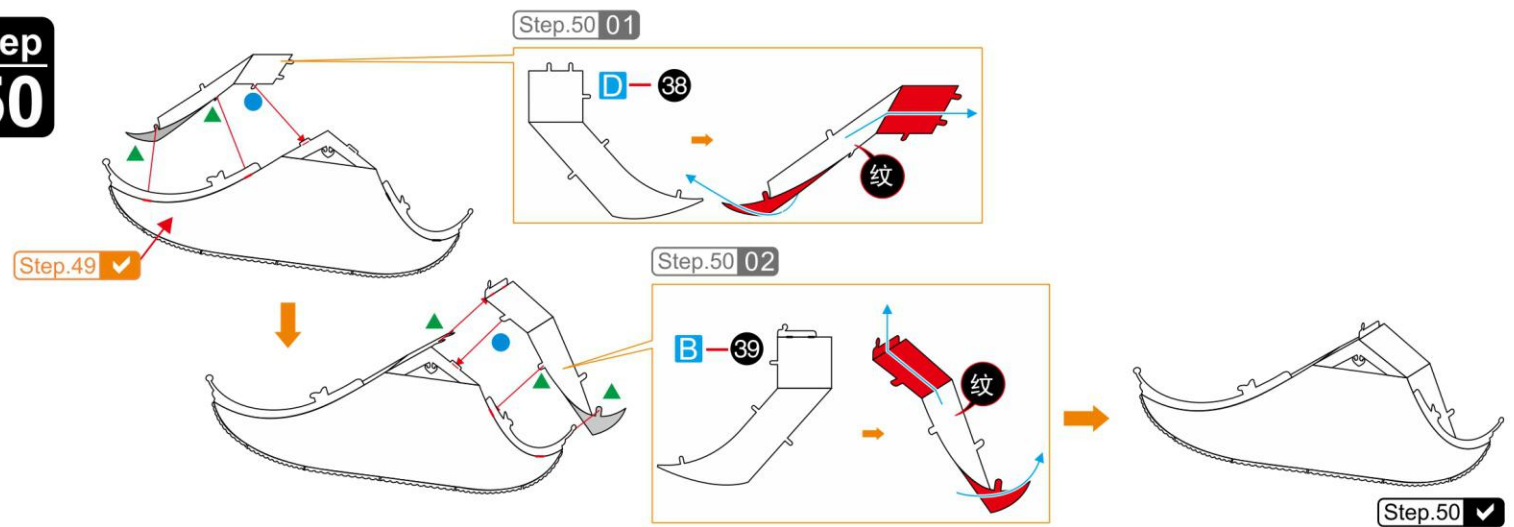

Step
51

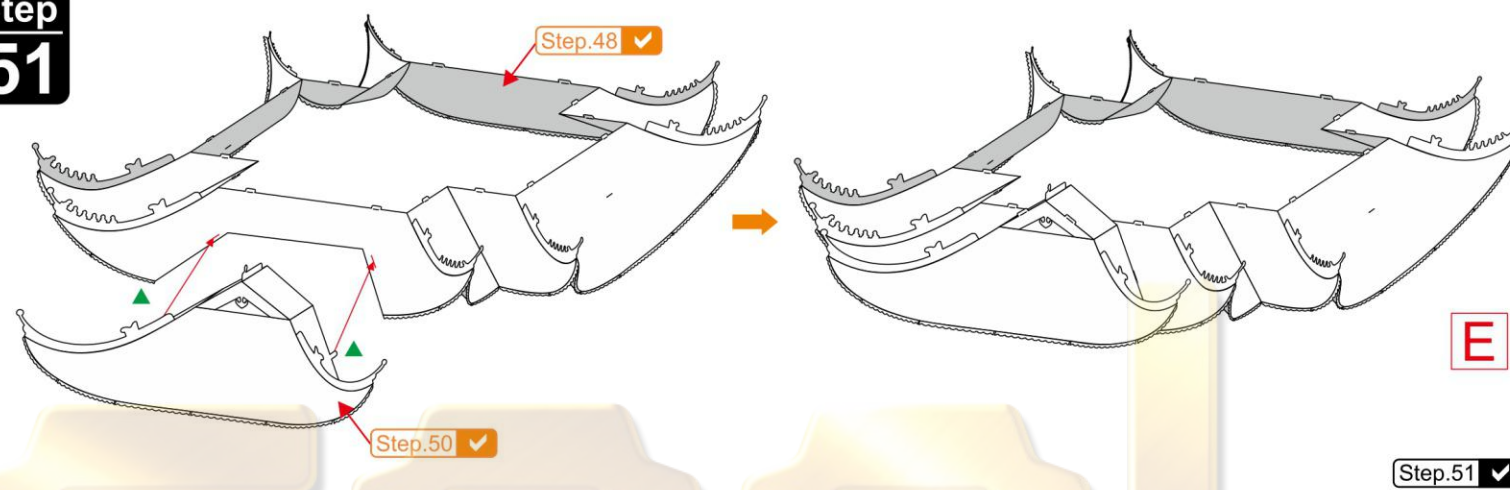

Step
52

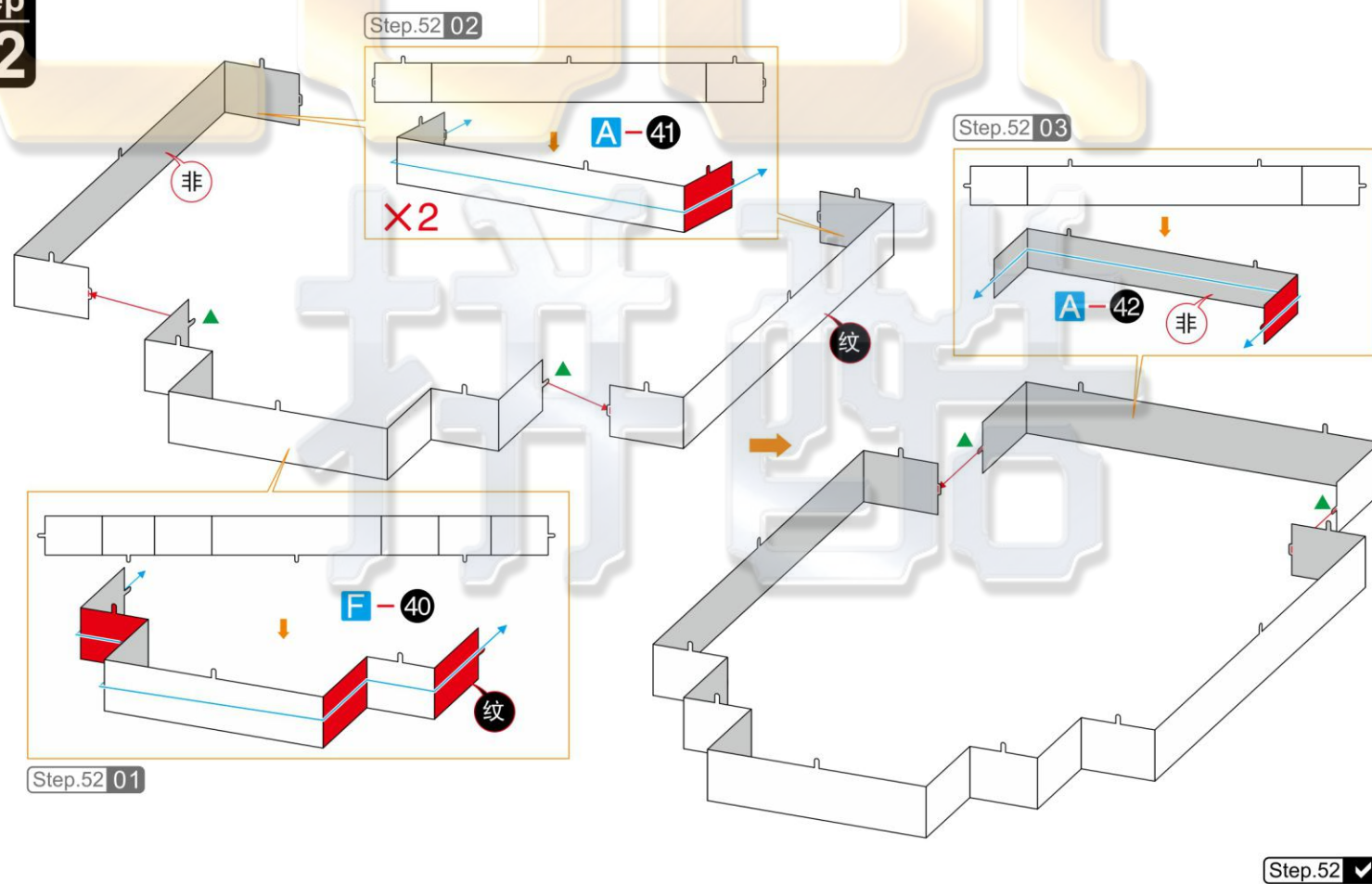

Step
53

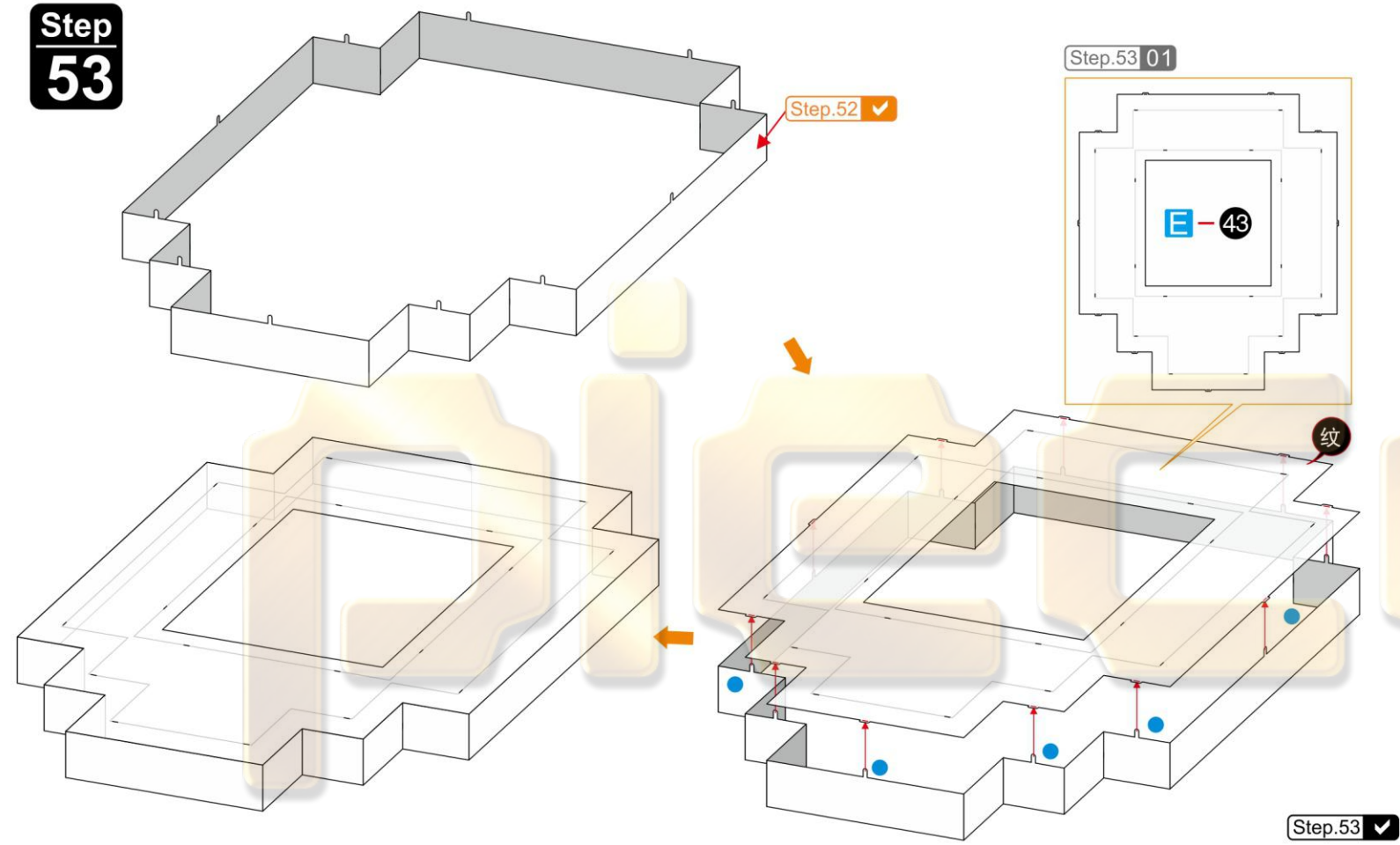

Step.53 ✓

Step
54

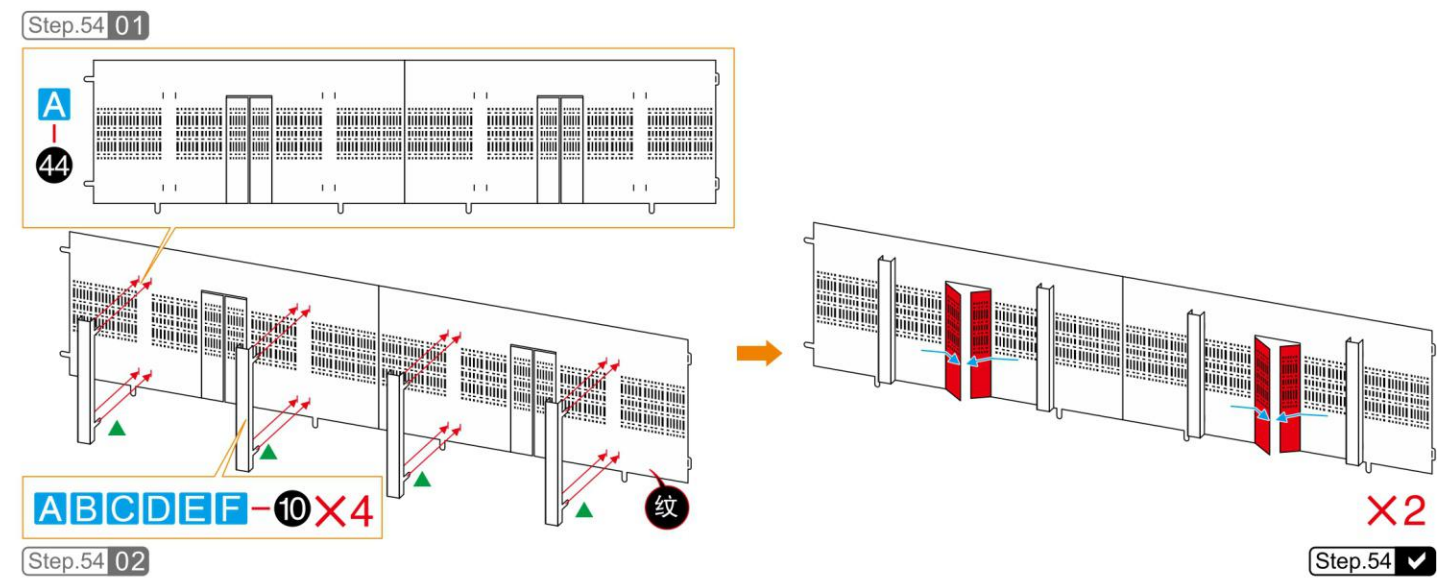

Step.54 ✓

Step
55

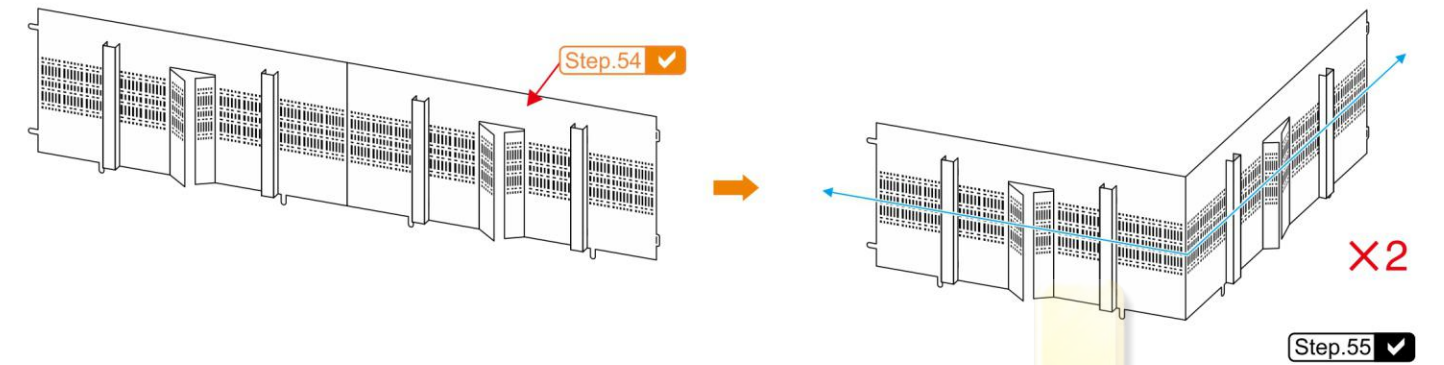

Step.55 ✓

Step
56

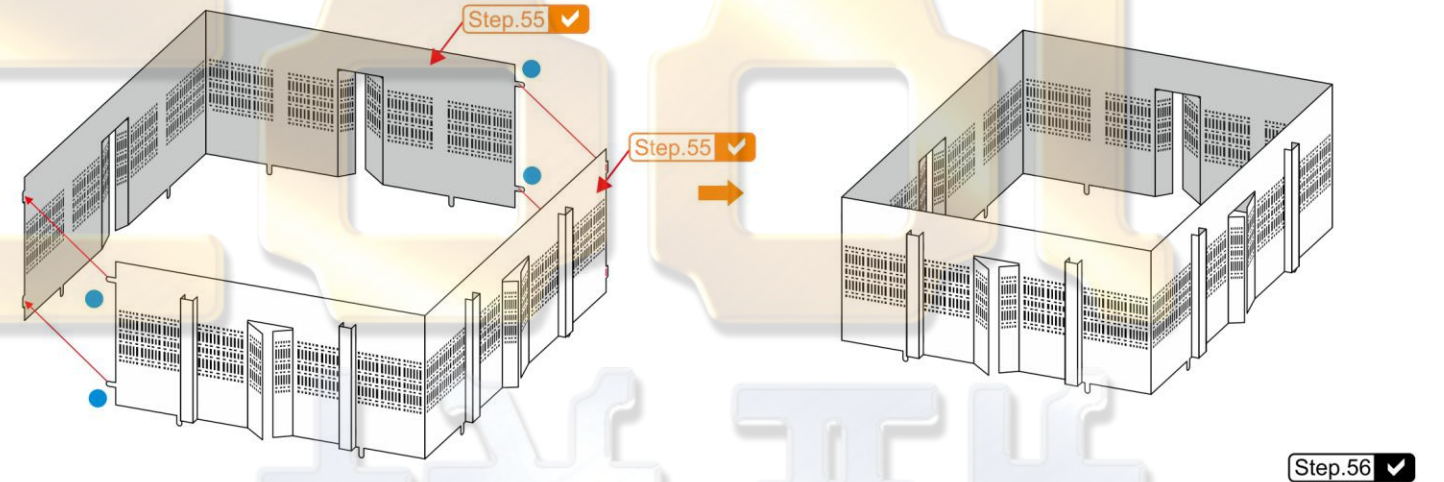

Step.56 ✓

Step
57

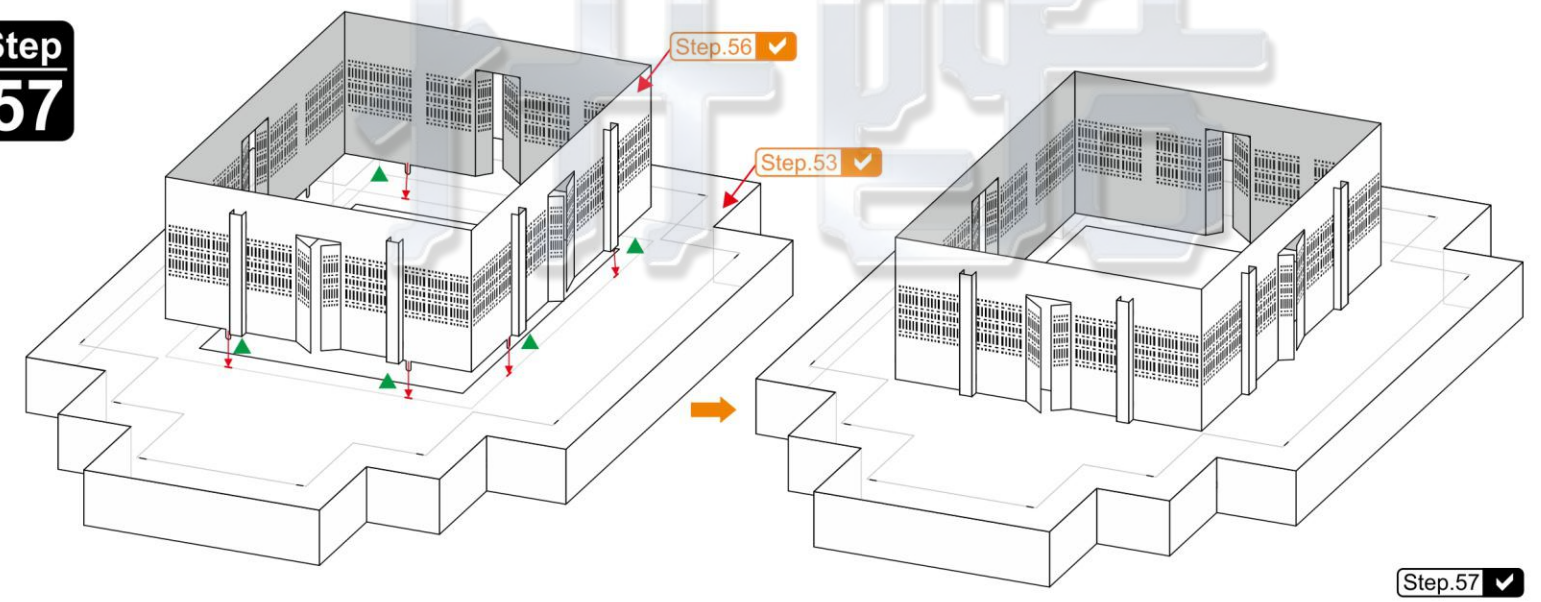

Step.57 ✓

Step 58

Step.58 01

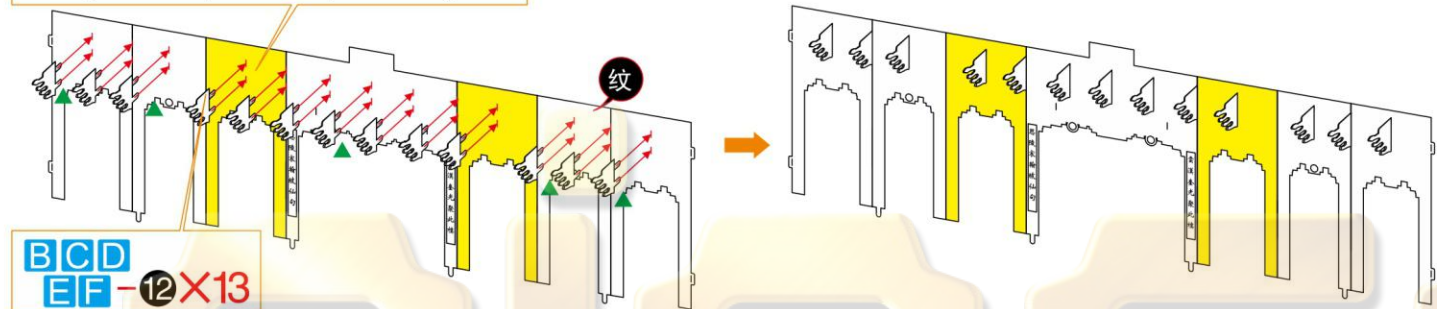
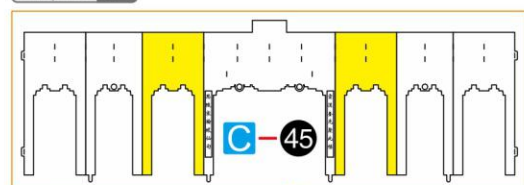

Step.58 02

Step.58

Step 59

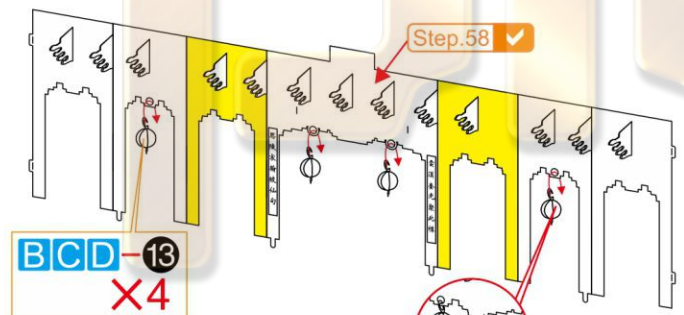

Step.59 01

圆环扣进扣孔之后，
请用尖嘴钳工具固定。

Step.59

Step 60

Step.60 01

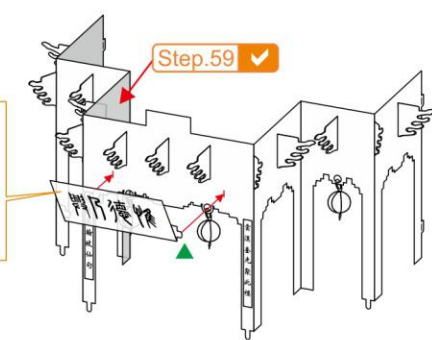

Step.60

Step 61

Step.61 01

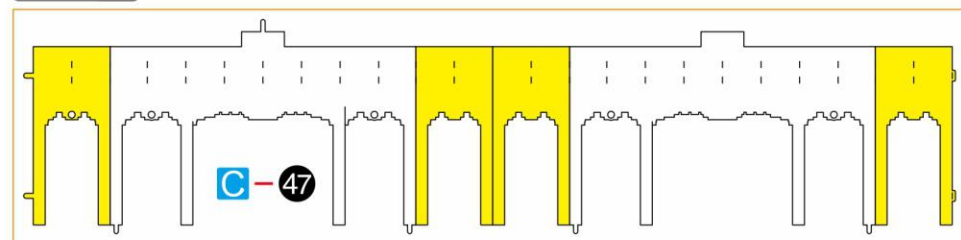

Step.61 02



圆环扣进扣孔之后，
请用尖嘴钳工具固定。



Step.61 03

Step.61

Step 62

Step.62 01

BCD EF-12X11

Step.62 02

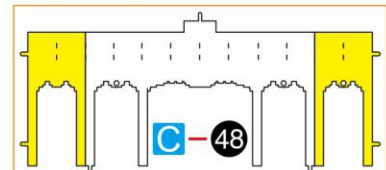

Step.62 03

BCD-13 X3

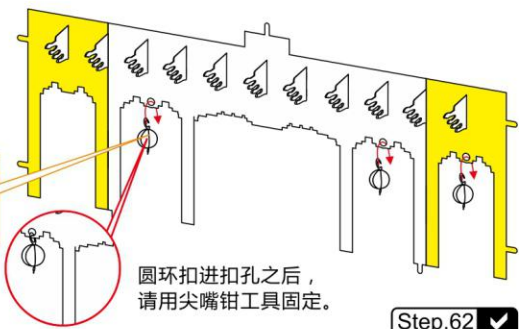

Step.62

Step 63

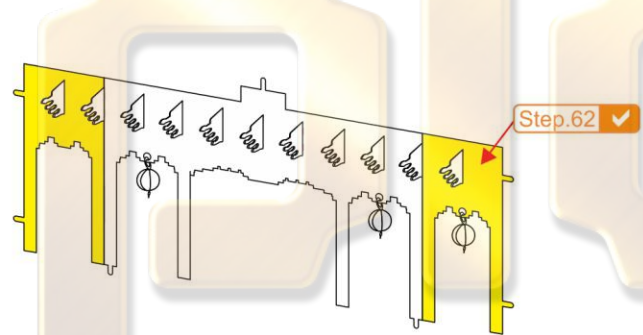

Step.62

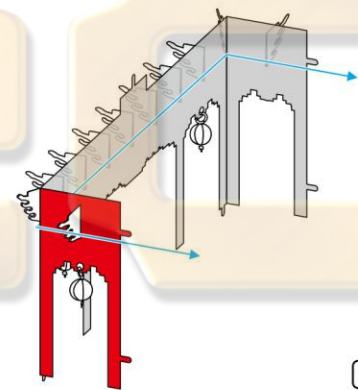

Step.63

Step 64

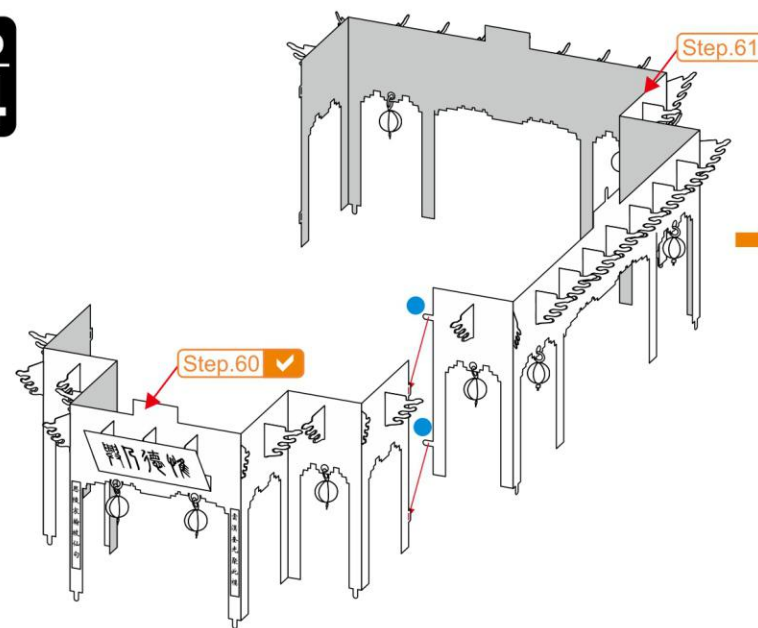

Step.60

Step.61

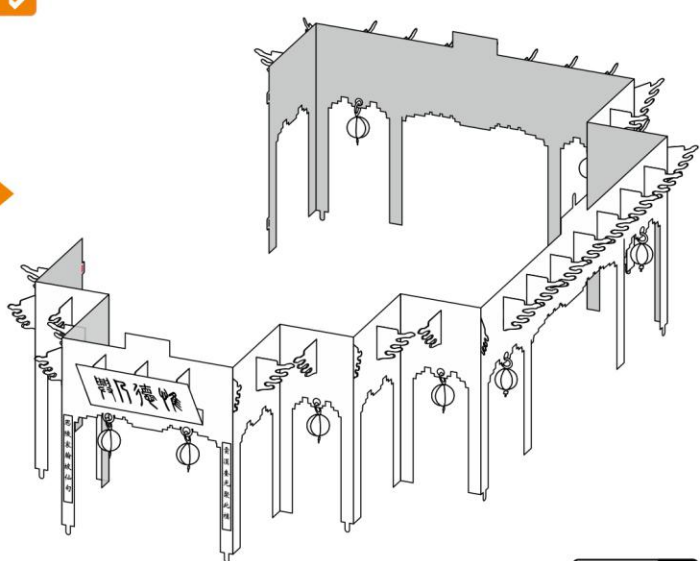

Step.64

Step 65

Step.63

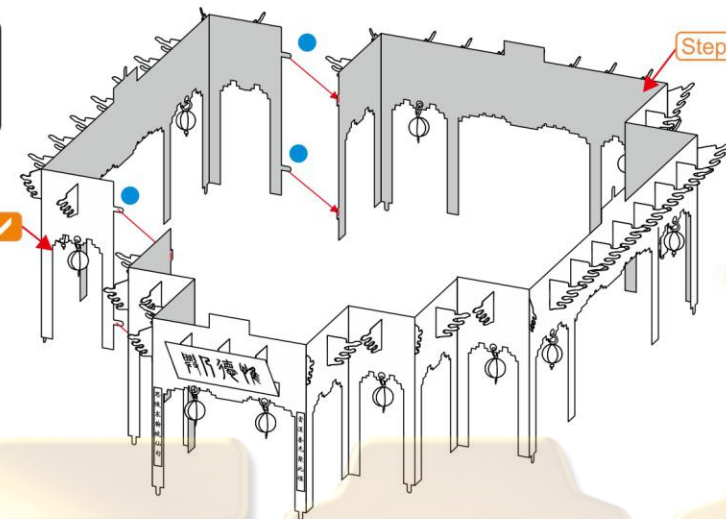

Step.64

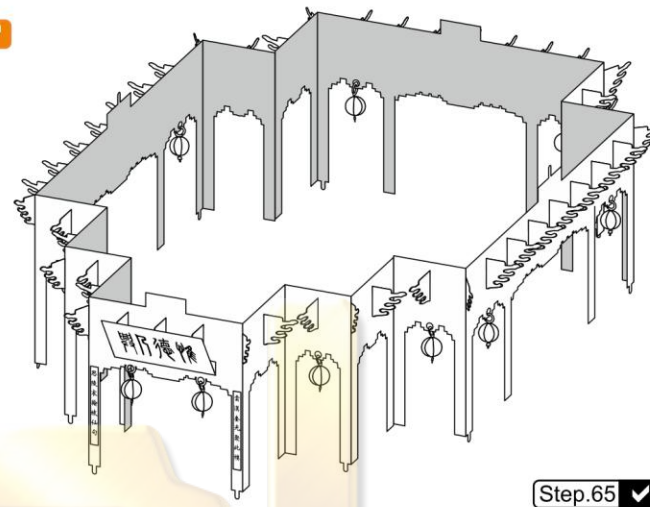

Step.65

Step 66

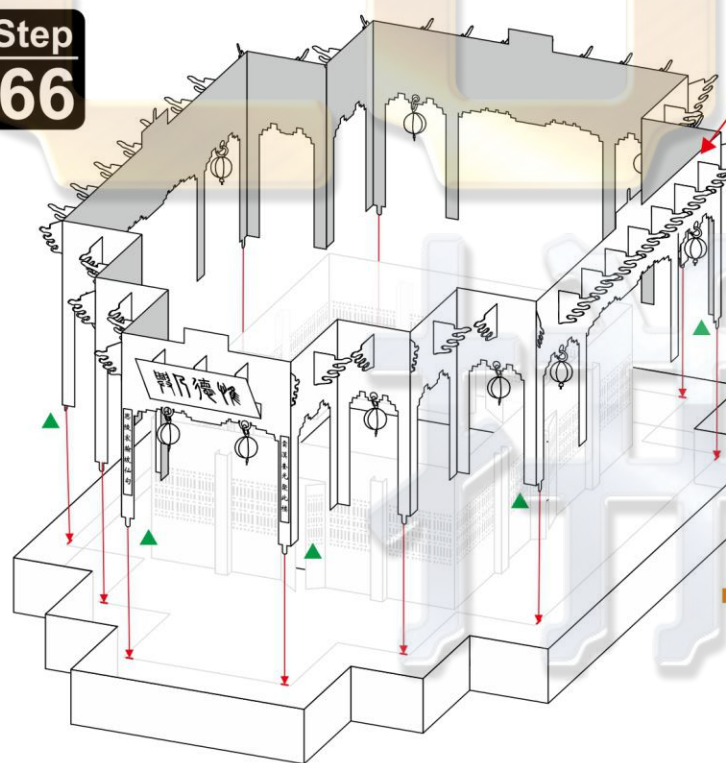

Step.65

Step.57

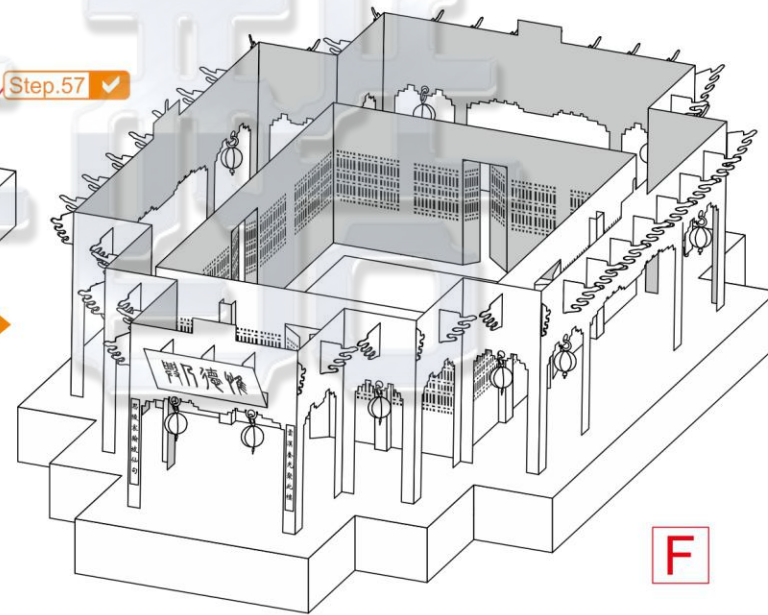

Step.66

Step 67

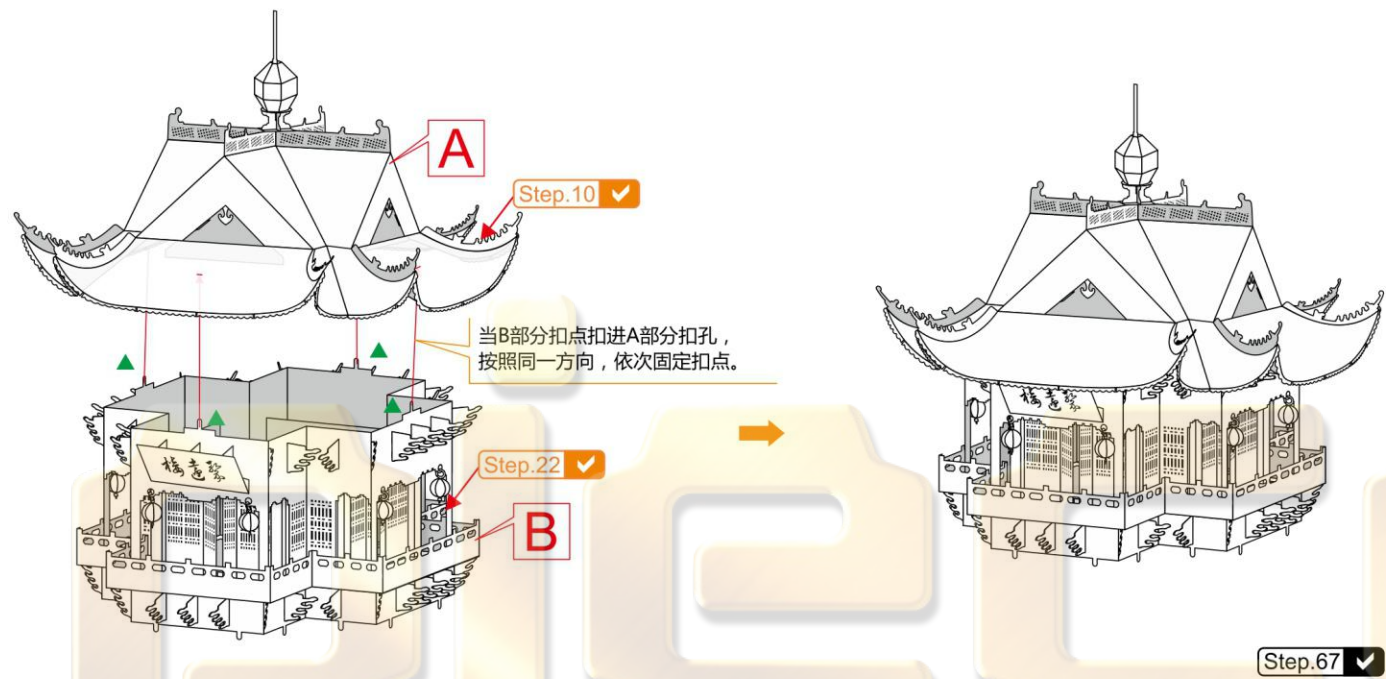

Step 68

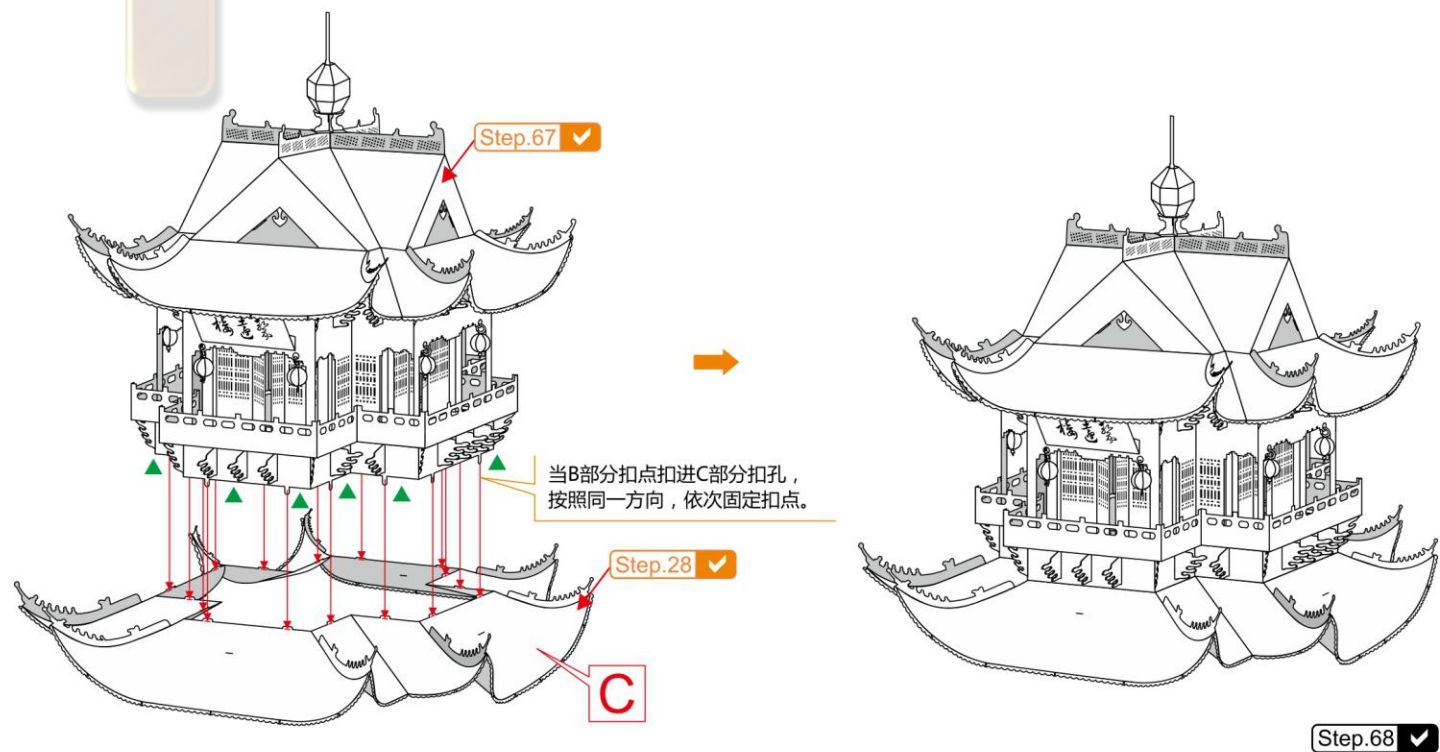

Step 69

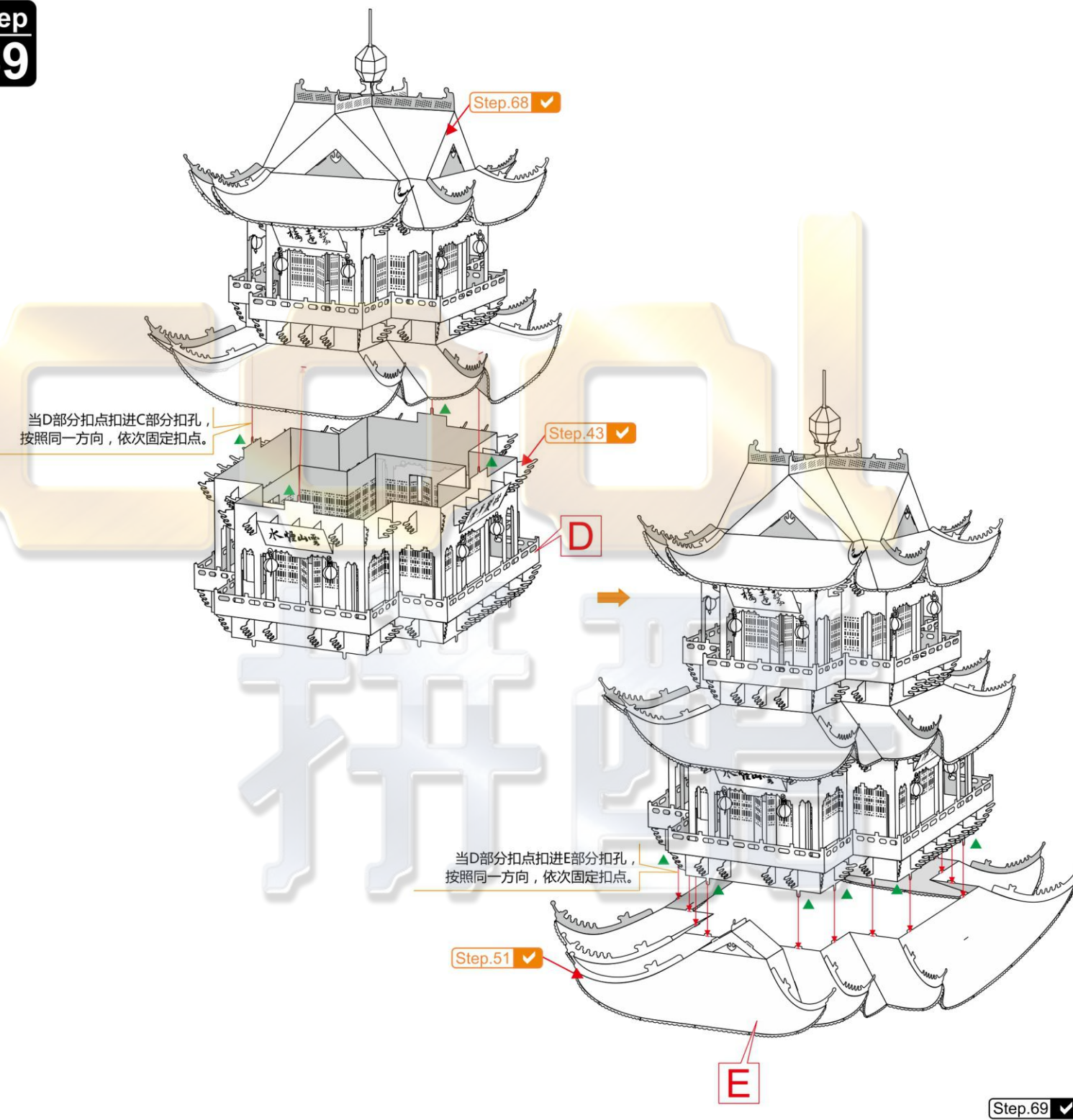

Step
70

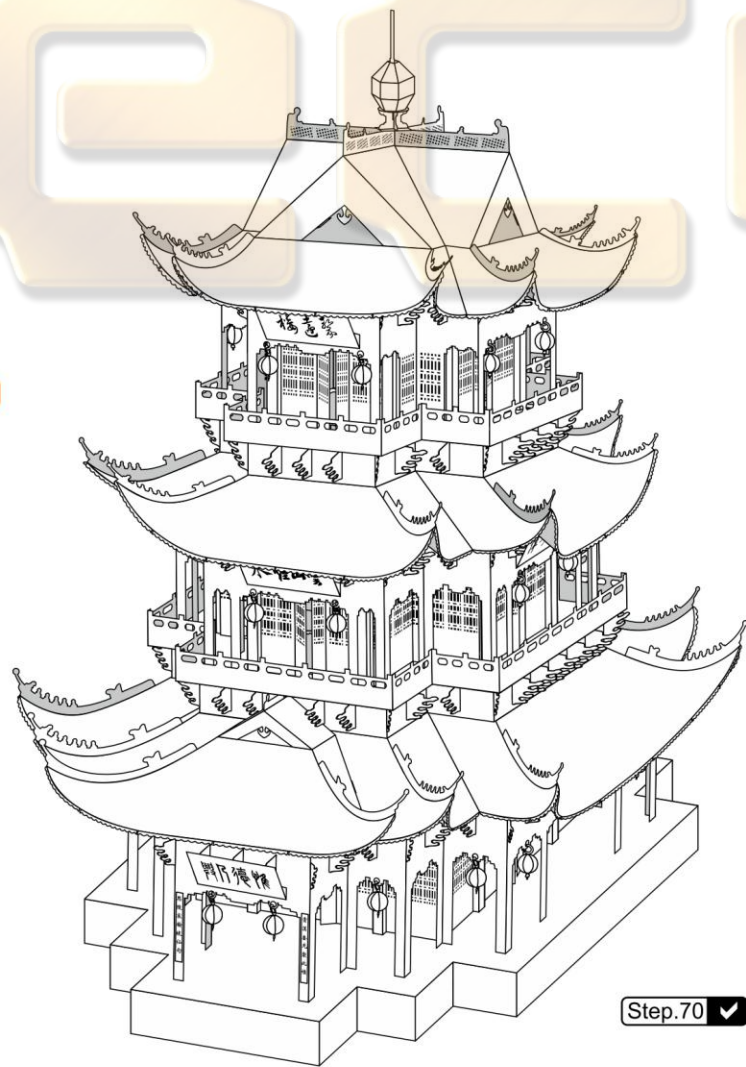
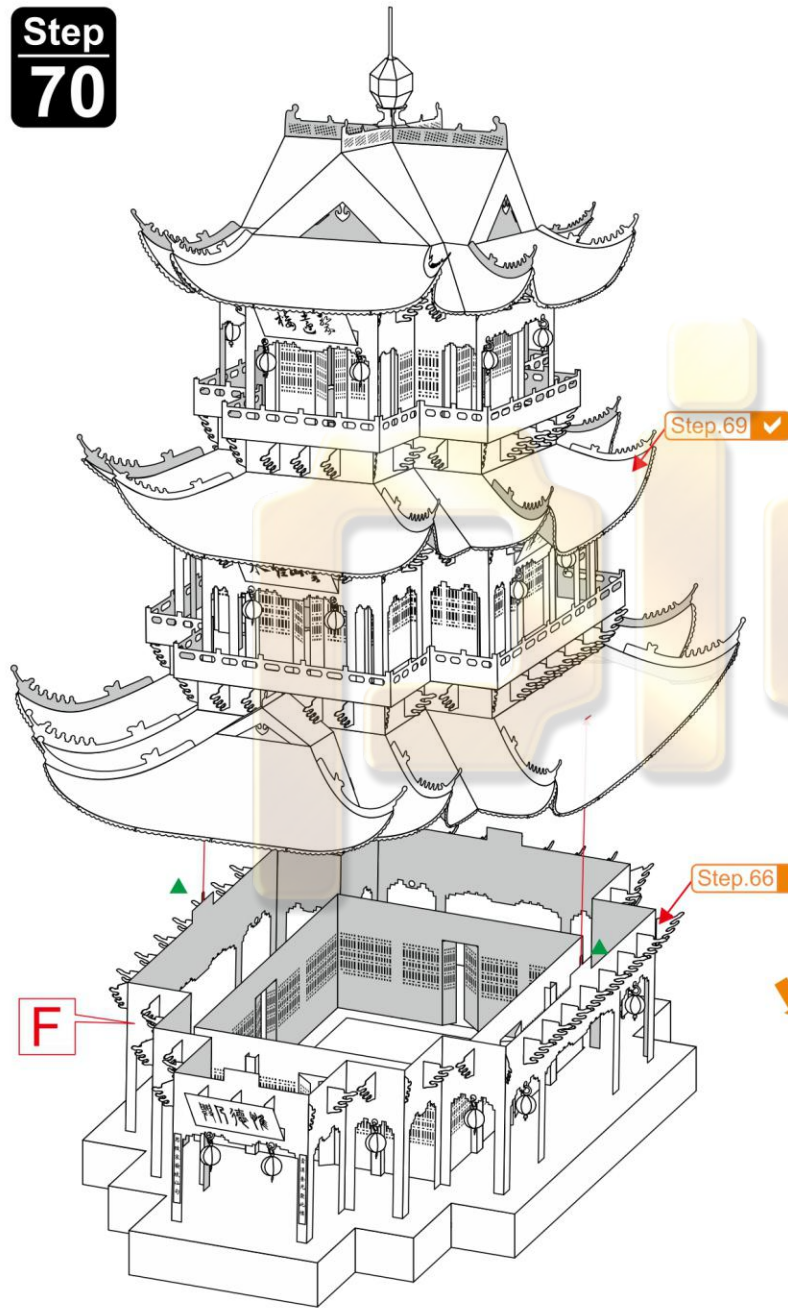

世 间 百 物 皆 有 因 果

拼 酷

更多产品信息, 请浏览www.Piececool.com官方网站

东莞市微石塑胶金属科技有限公司 出品
WIST PLASTIC & METAL TECHNOLOGY LIMITED
地址：广东省东莞市寮步镇向西工业区村口街2号 邮编：523408
电子邮箱：kf@wist-group.com
服务热线：0769-8119 2243

© Wist Plastic & Metal Technology Limited. All rights reserved.

CP-ASSY-P111#-A2-20210122