

Piececool
拼酷

大唐圣僧
THE HOLY MONK
OF TANG
P104

拼装说明书



AGES 14+

本产品为金属制品，14岁以下需由成人陪同完成！

© WIST PLASTIC & METAL TECHNOLOGY LIMITED. ALL RIGHTS RESERVED.

电子版下载地址：<http://www.piececool.com/cpshuoming/P104.pdf>

拼前需知:

Piececool 拼酷

● 准备工具:



建议使用拼酷正品拼装工具（水口钳、尖嘴钳），拼装时更省心、省力，拼装后作品更精细、美观！

● 拼装方法:

a. 取下零件



使用水口钳剪断金属零件上的水口，将需要的金属零件从金属片板件取下。

b. 识别零件



识别金属零件上的扣点、折叠线、扣孔的样子。

c. 折叠零件

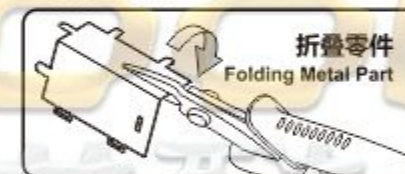

使用尖嘴钳，参照拼装说明书将金属零件折成形状。

d. 固定零件



● 插入扣孔，平折 90°



▲ 插入扣孔，旋转 90°

● 注意事项:

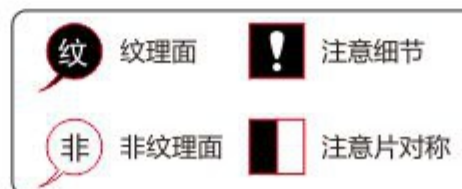

剪金属零件时请剪零件“水口位”，请勿将“扣点”当成“水口位”剪下，每次剪零件时请仅剪当前步骤的零件，切勿一次性将所有零件全部剪下，避免丢失；

当遇到折叠线的零件，请注意金属片的正反面及拼折方向，请按照说明书说明的方向，轻剪慢折，最好一次折叠完成，请勿反复折叠，避免零件损坏。

拼装步骤:

Piececool 拼酷

Step
01

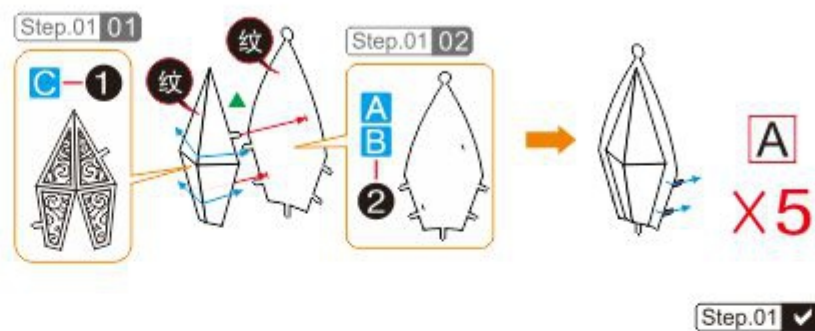

Step
02

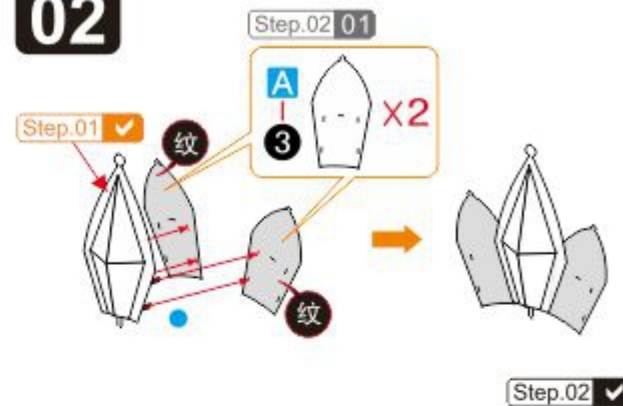

Step
03

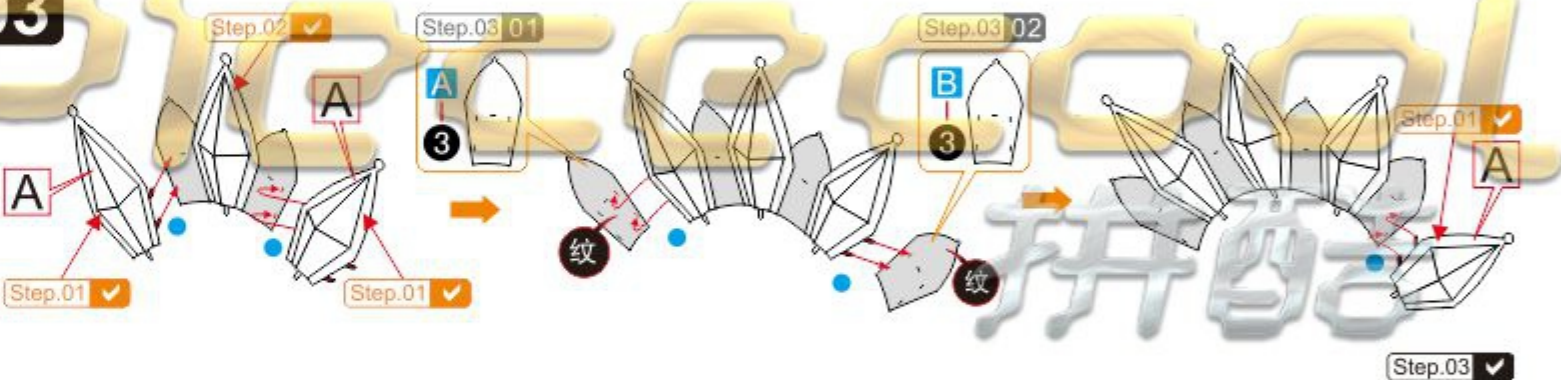

Step
04

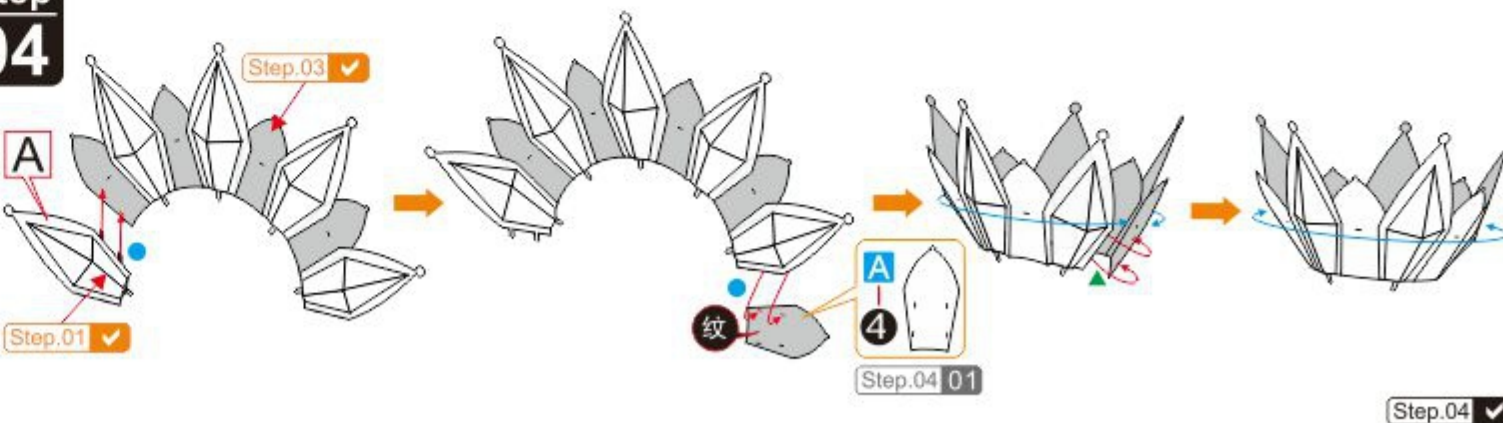

Step 05

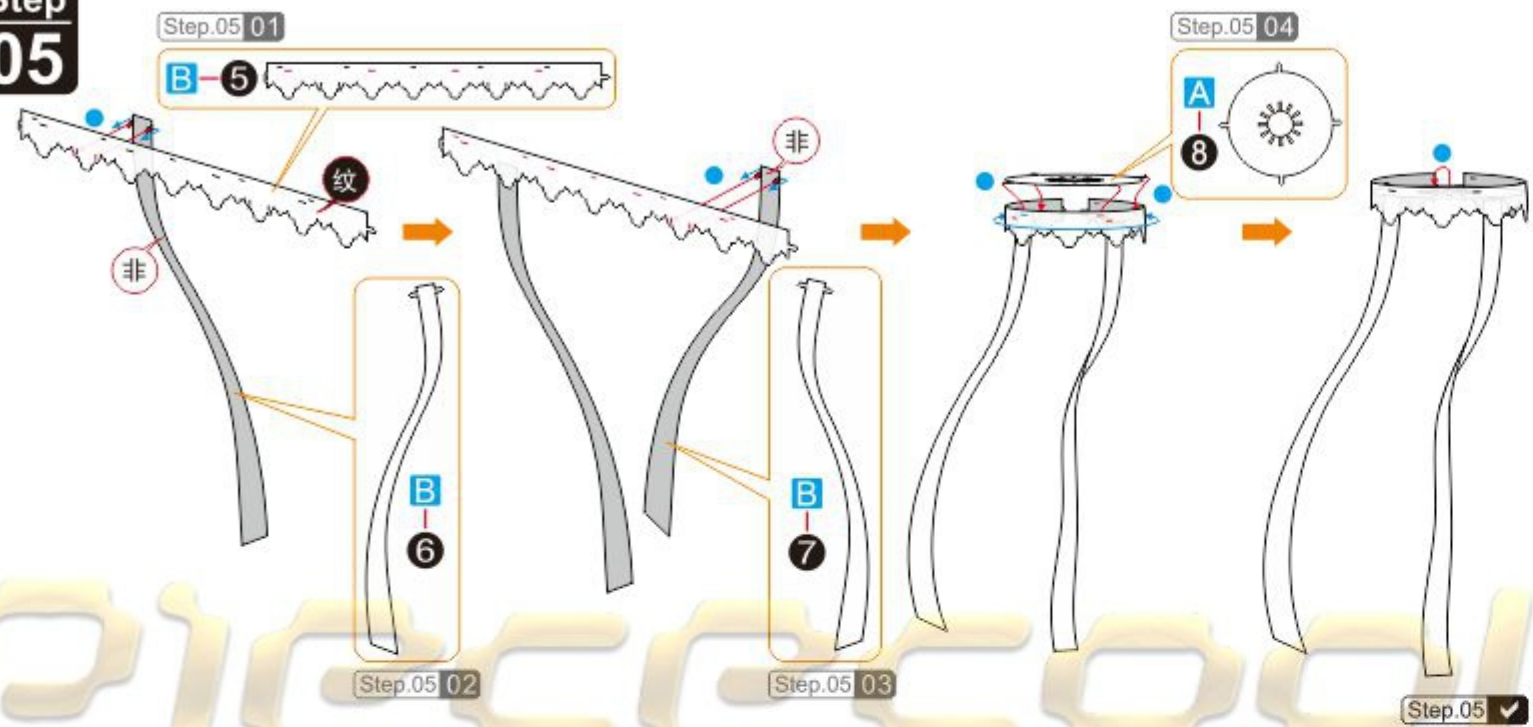

Step 06

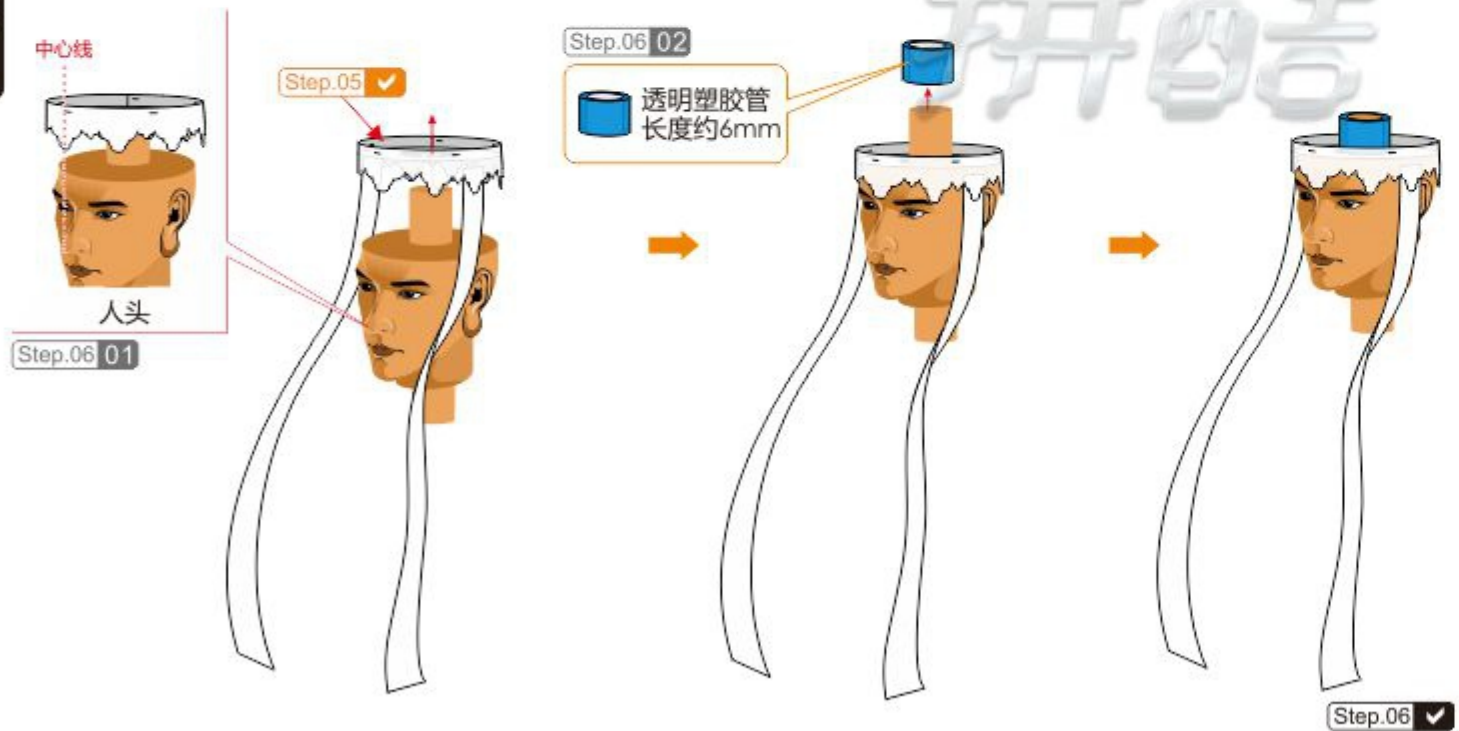

Step 07

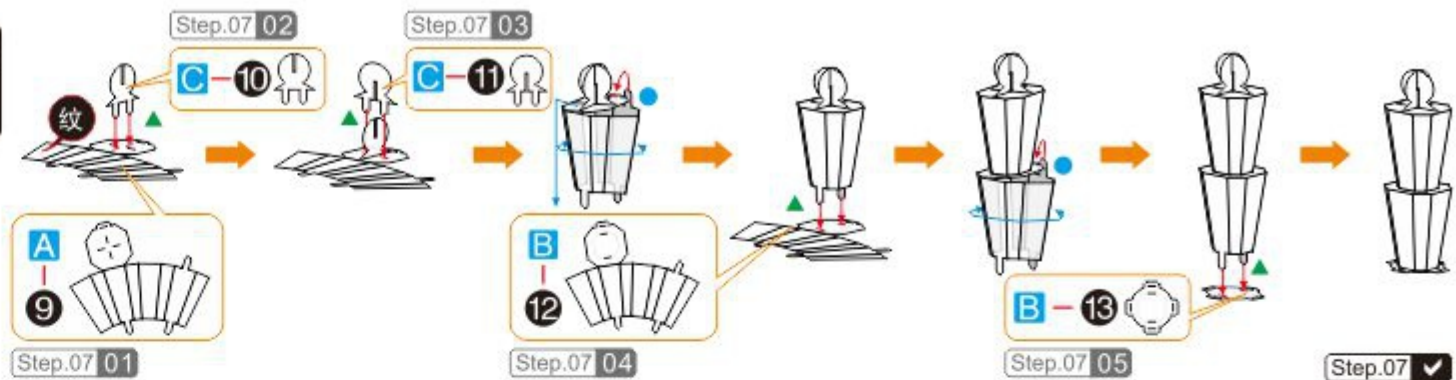

Step 08

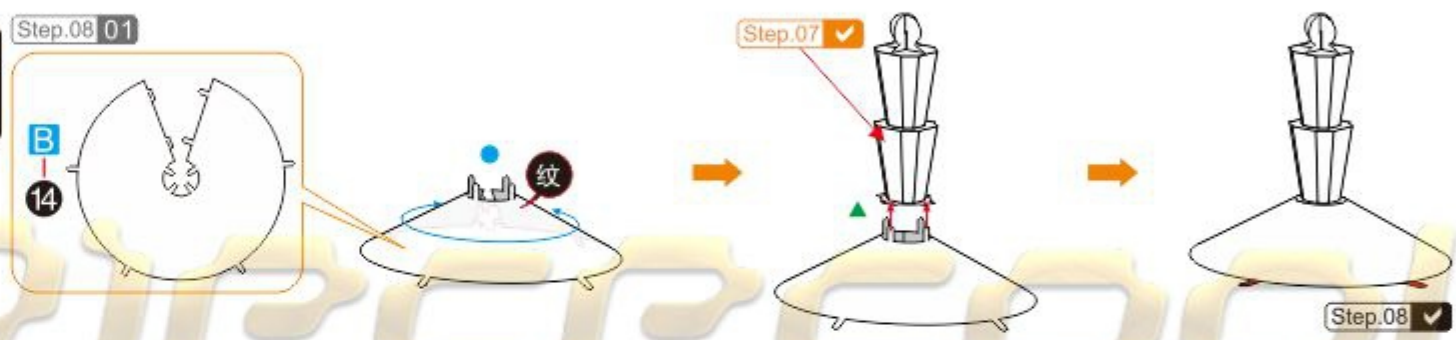

Step 09

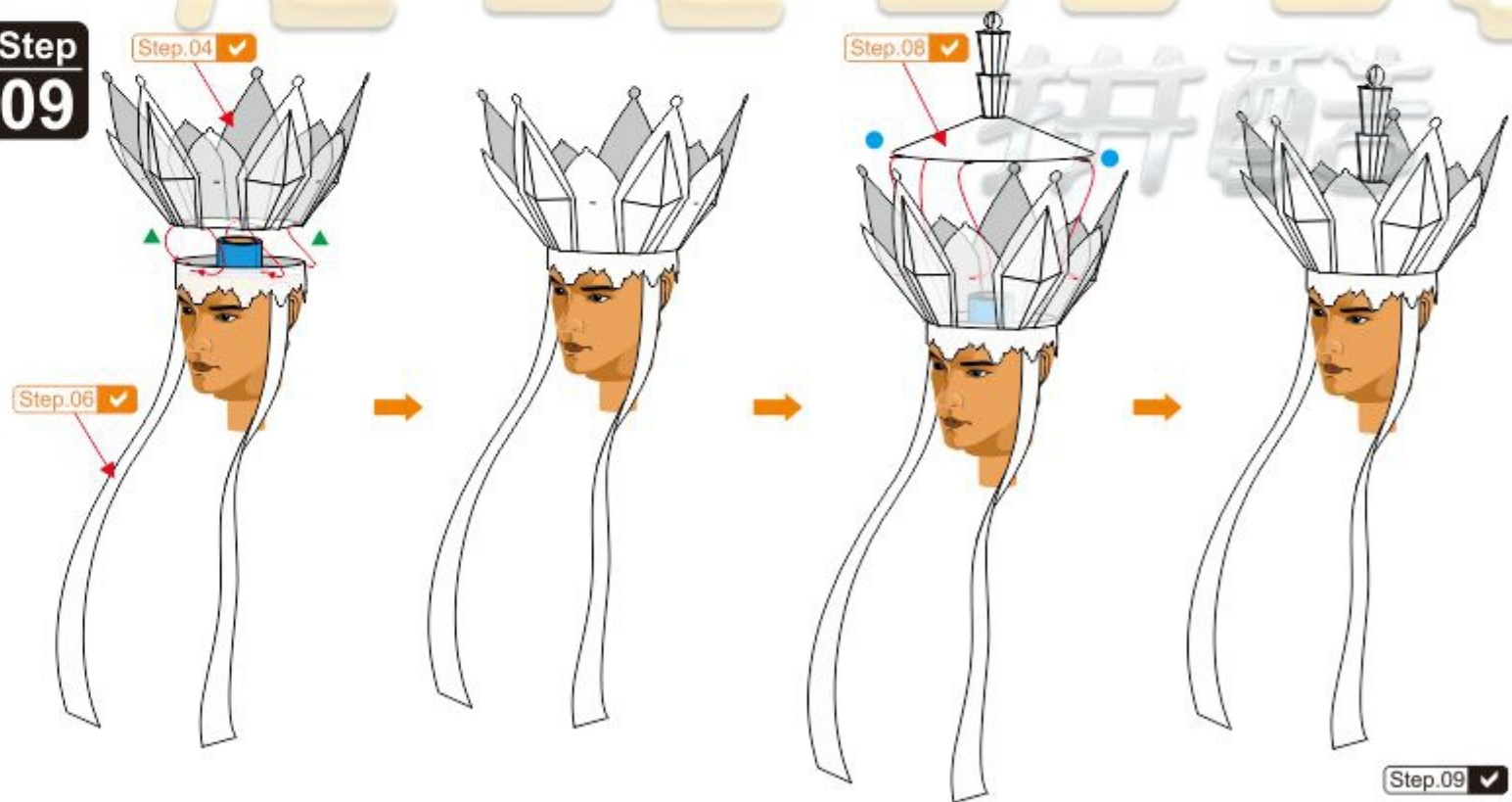

Step 10

Step.10 02

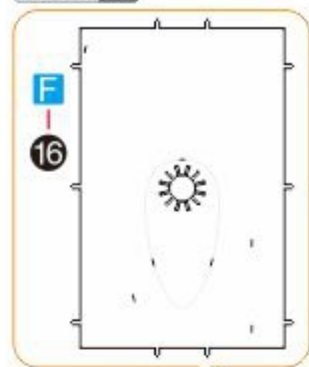

Step.10 01

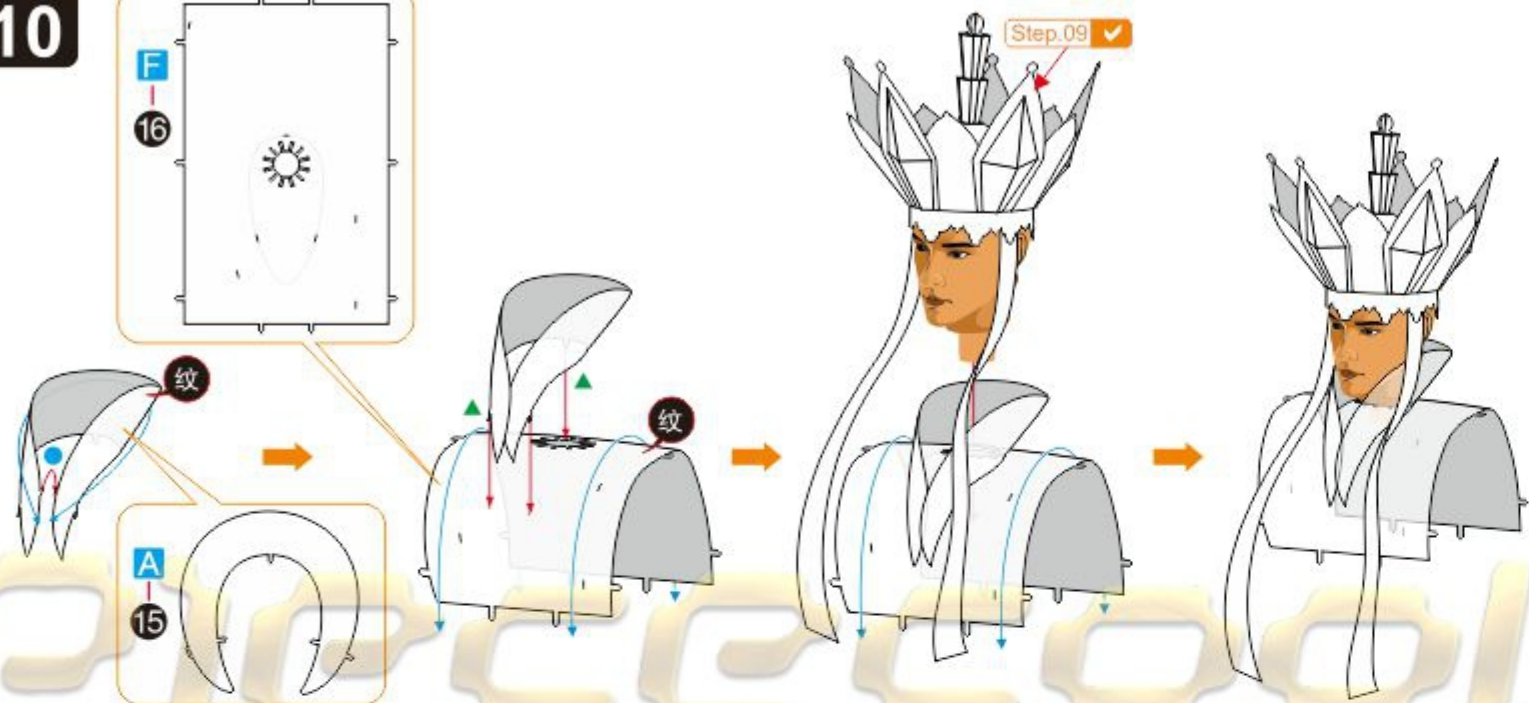

Step.10 ✓

Step 11

Step.11 02



透明塑胶管
长度约6mm

Step.11 01



Step.11 ✓

Step 12

Step.12 01

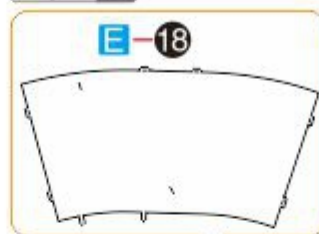

Step.12 02

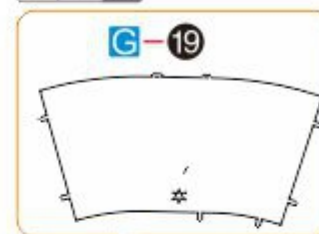

Step.12 01

Step.12 ✓

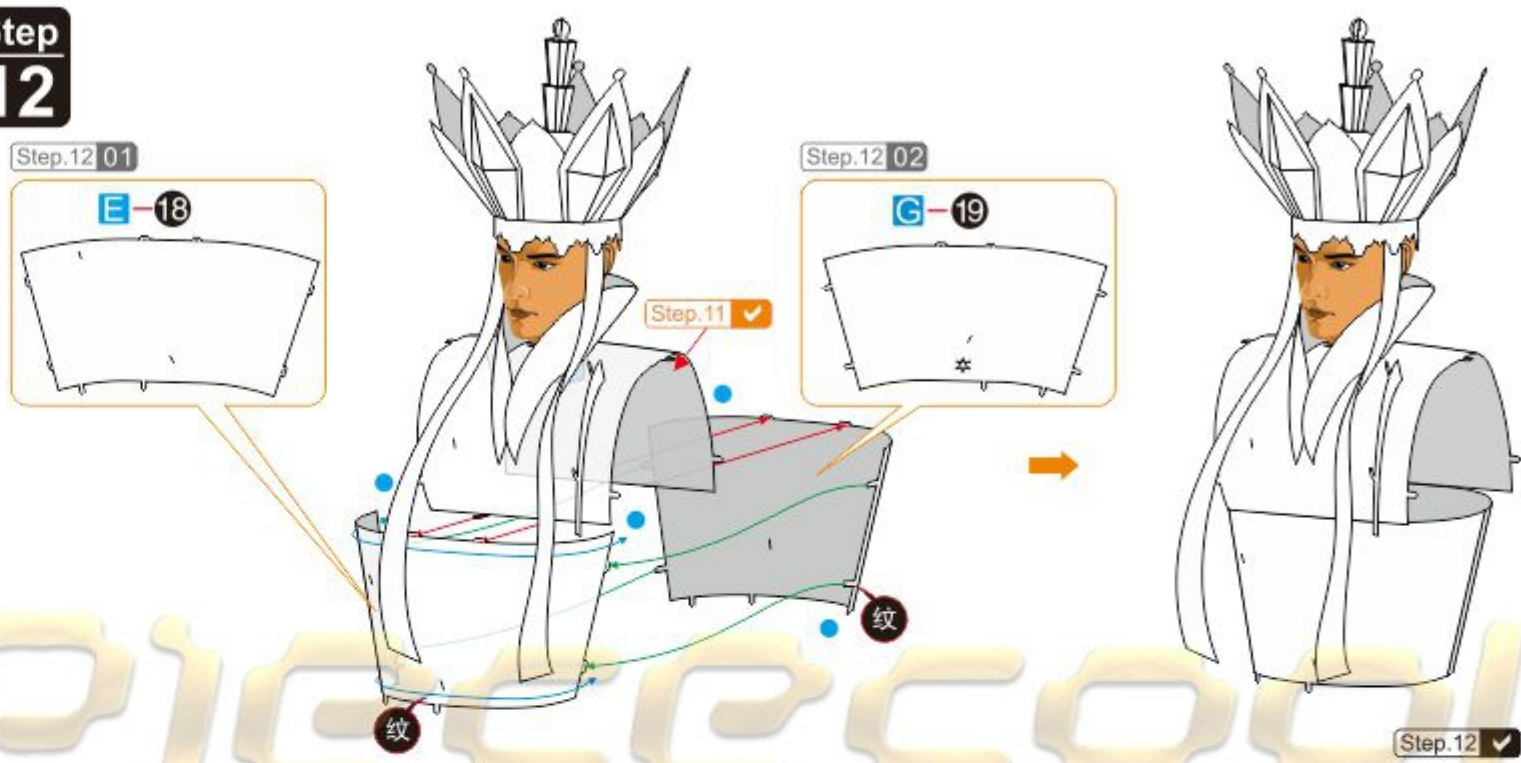

Step 13

Step.13 01

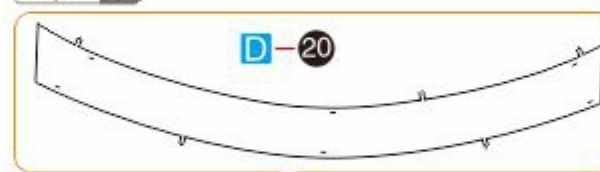

! 此处红色扣点
向外折90°

! 此处红色扣点向外折90°



Step.13 02

Step.13 ✓

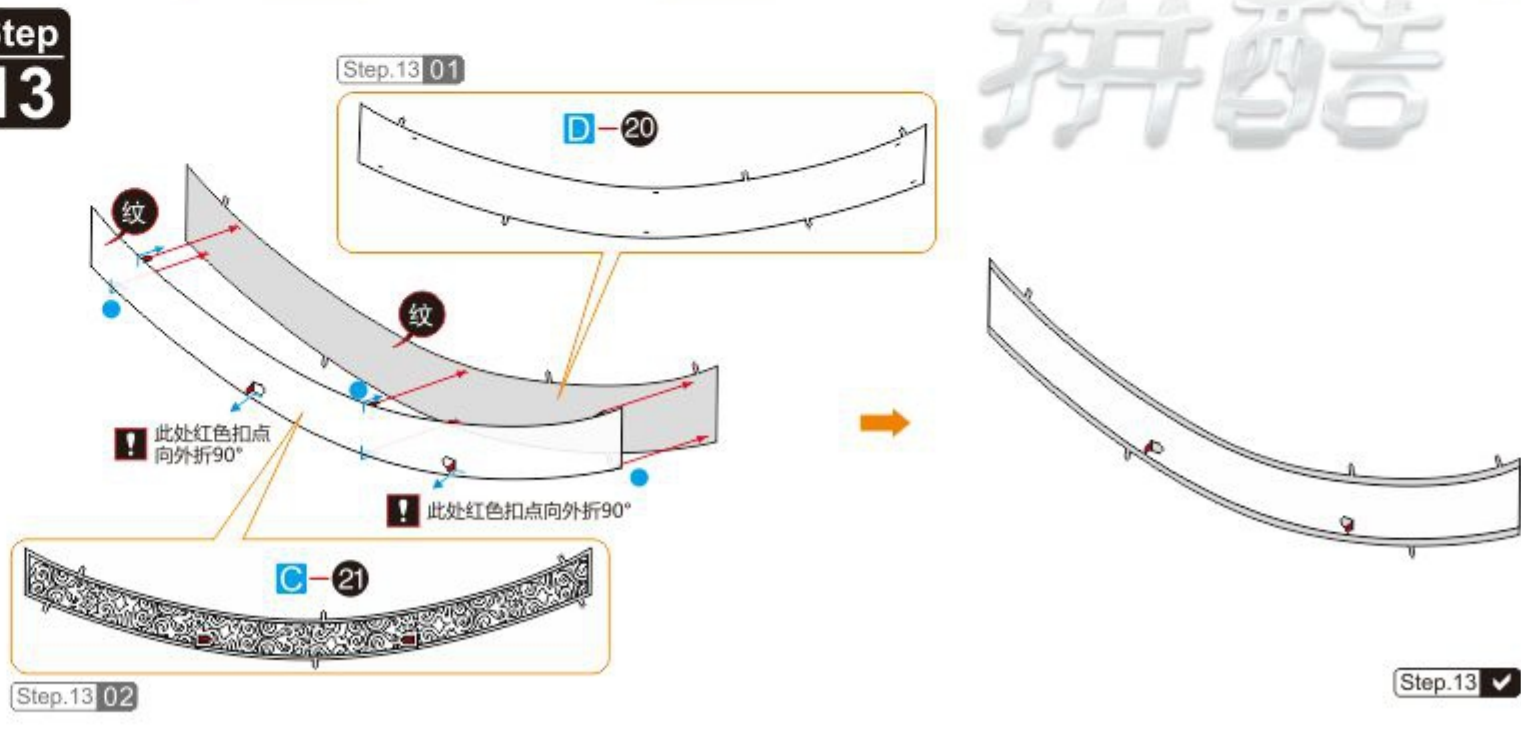

Step
14

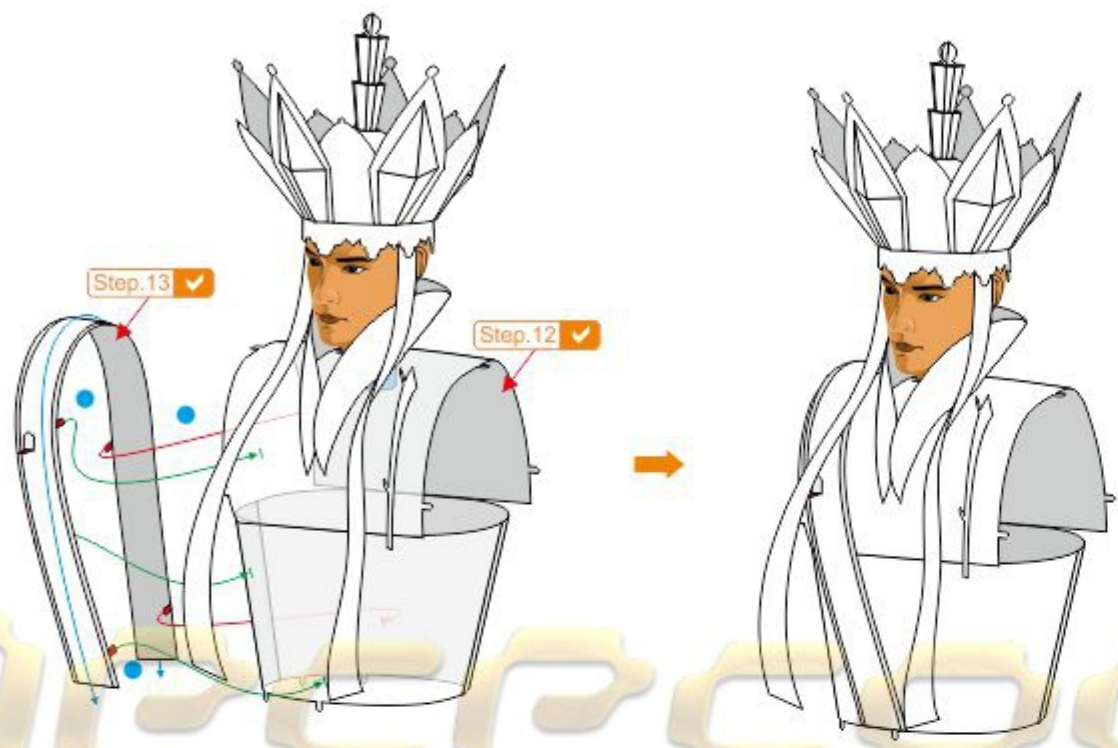

Step.14 ✓

Step
15

Step.15 01



Step.15 02

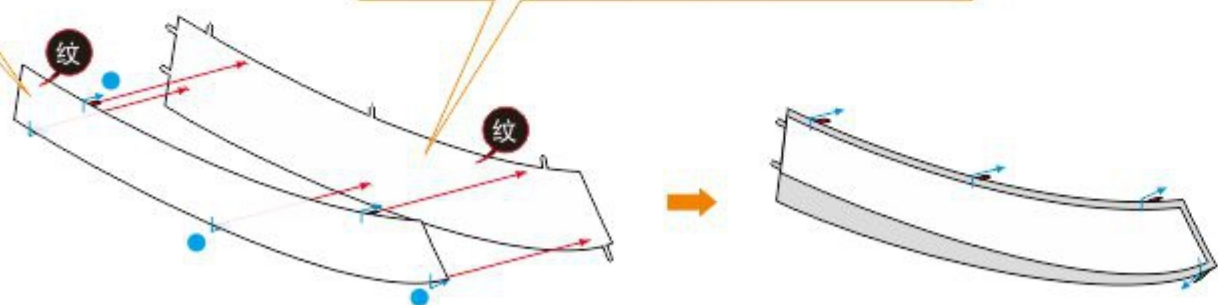
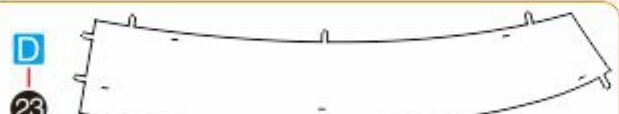

Step.15 ✓

Step
16

Step.16 01

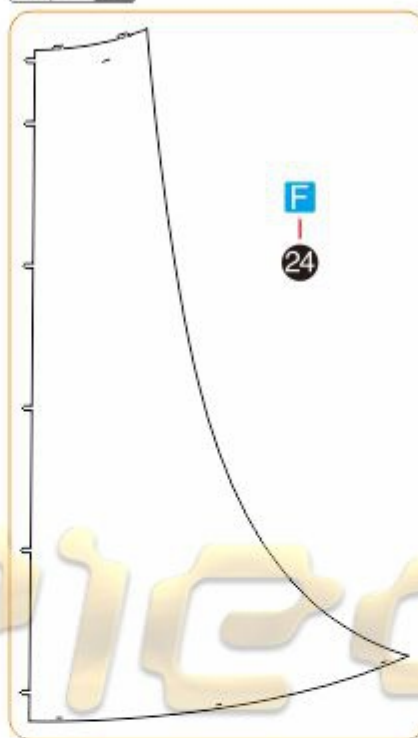

Step.16 ✓

Step
17

Step.17 01



Step.17 02

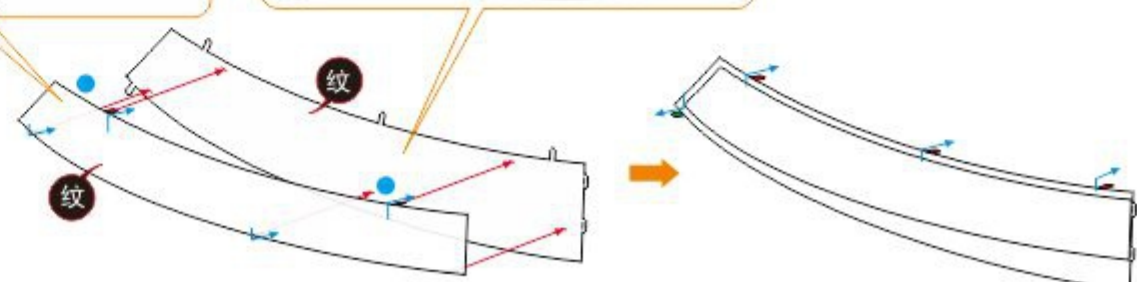

Step.17 ✓

Step 18

Step.18 01

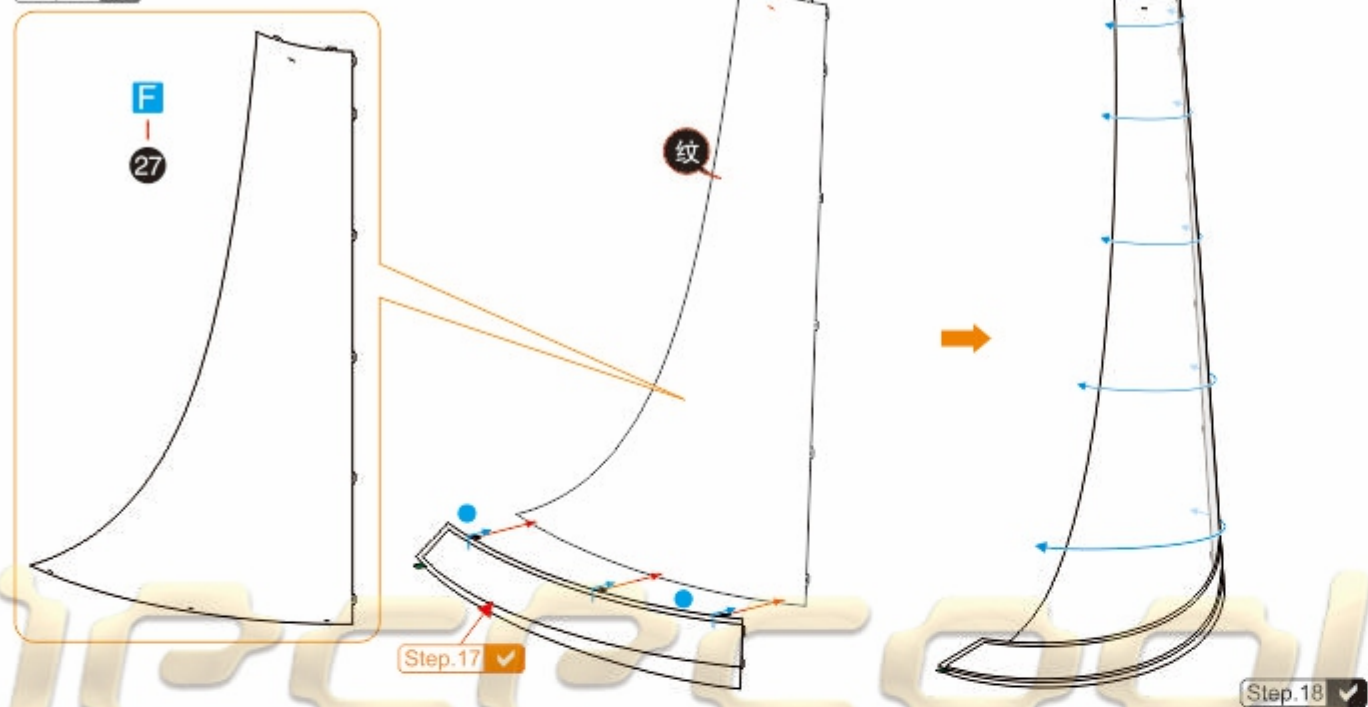

Step 19

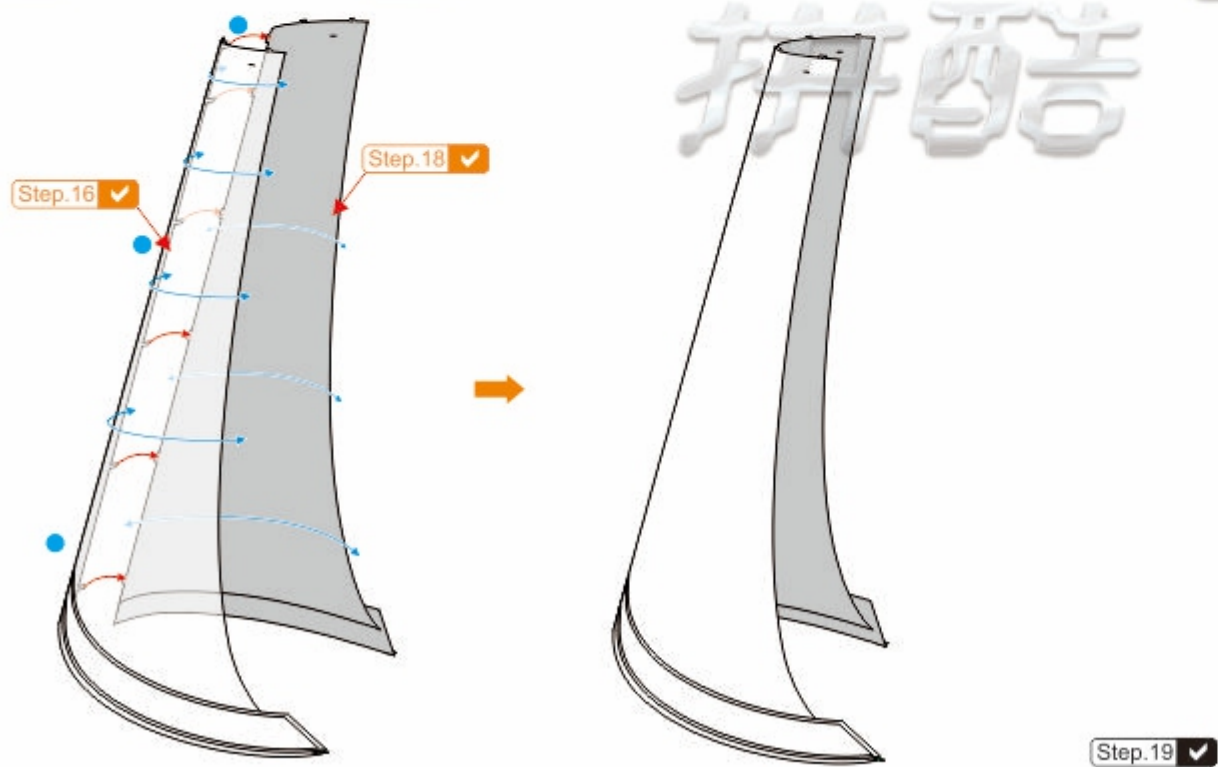

Step 20

Step.20 02

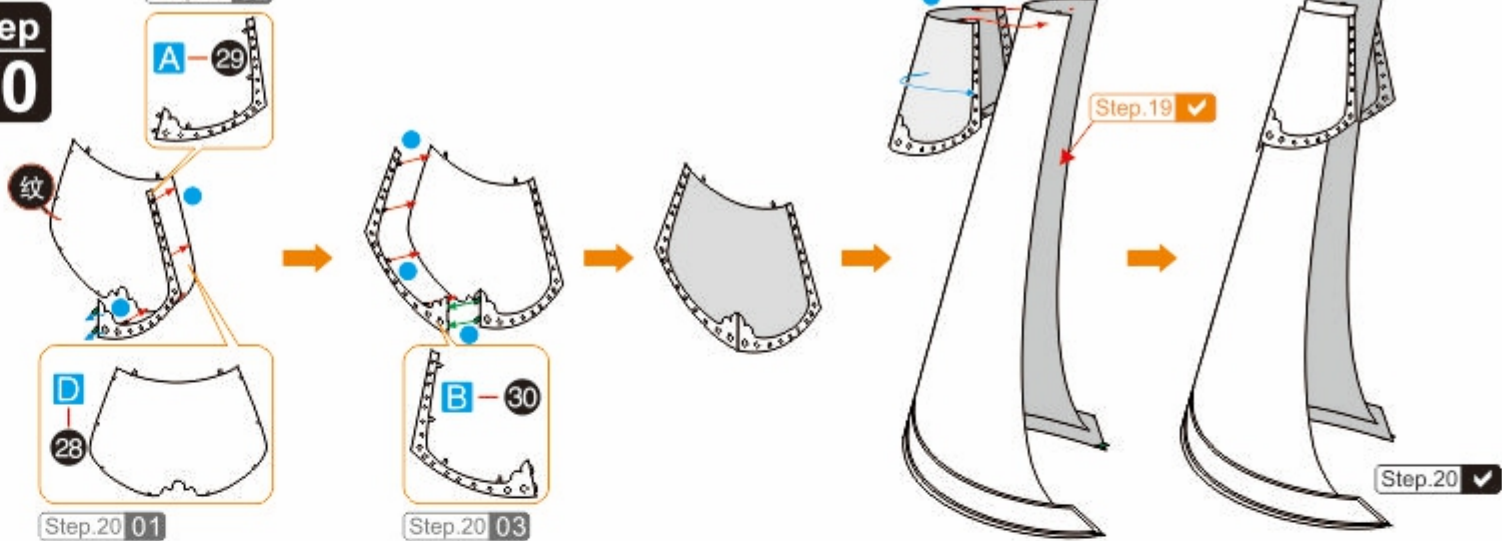

Step 21

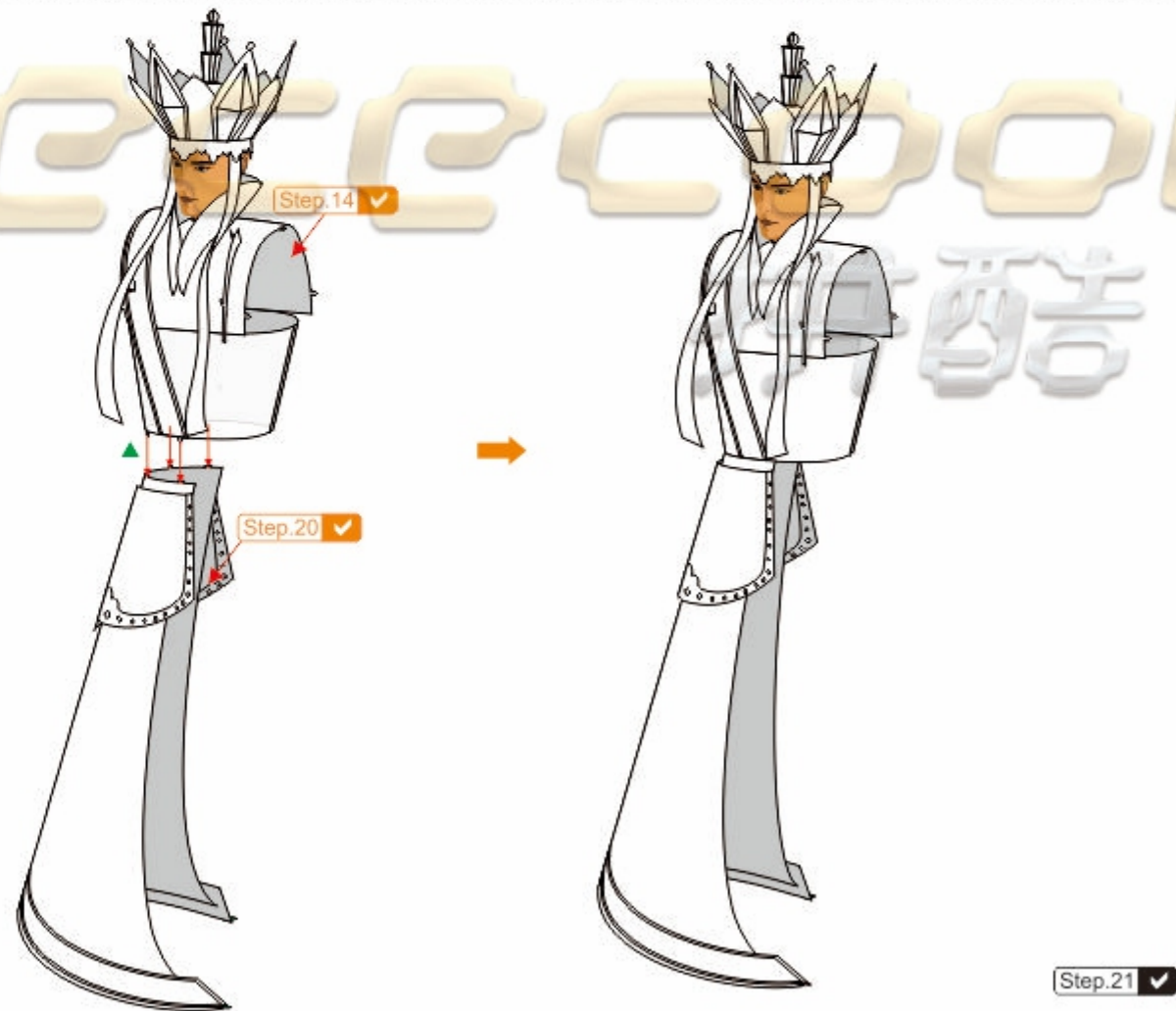

Step
22

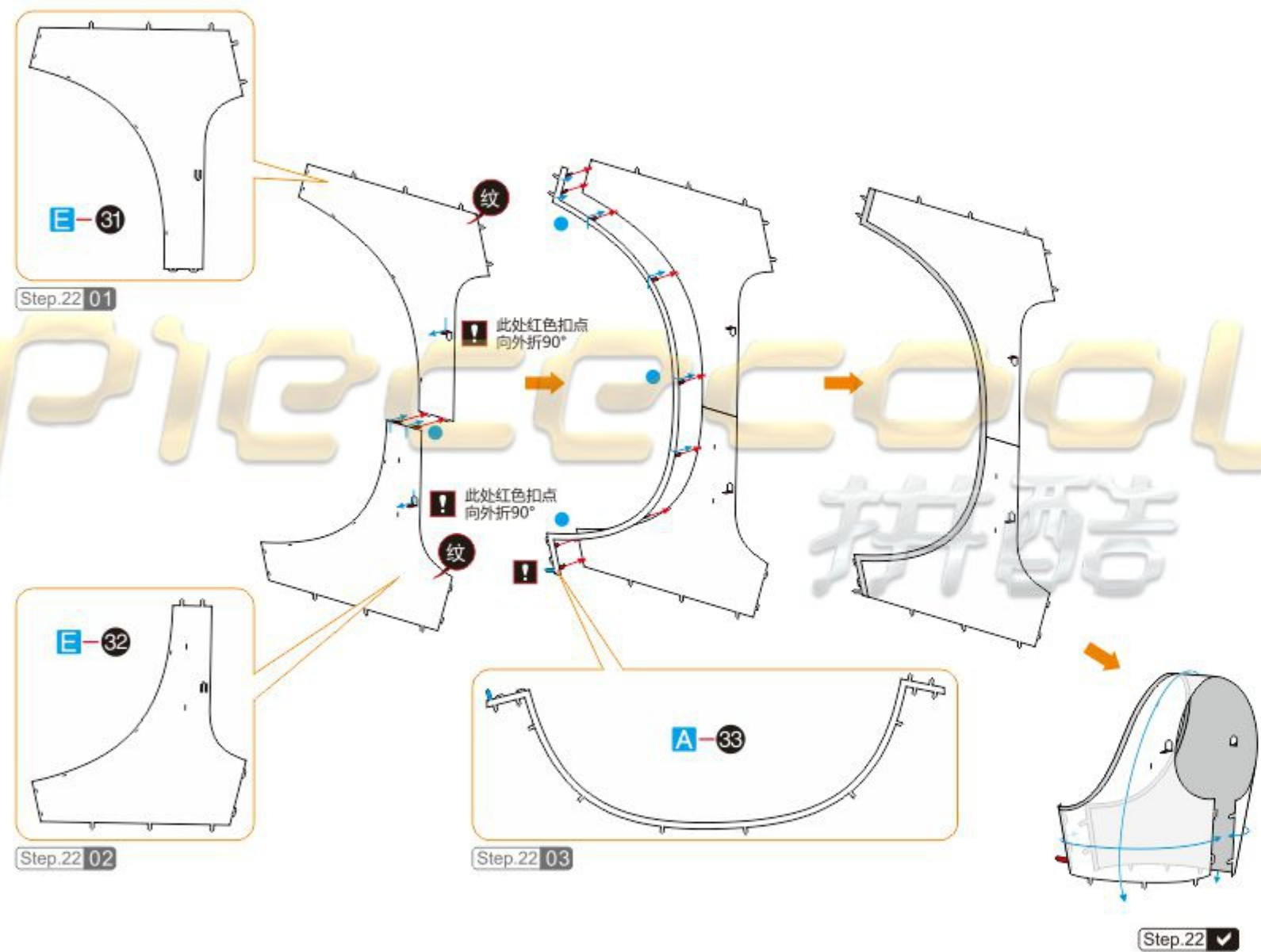

Step
23

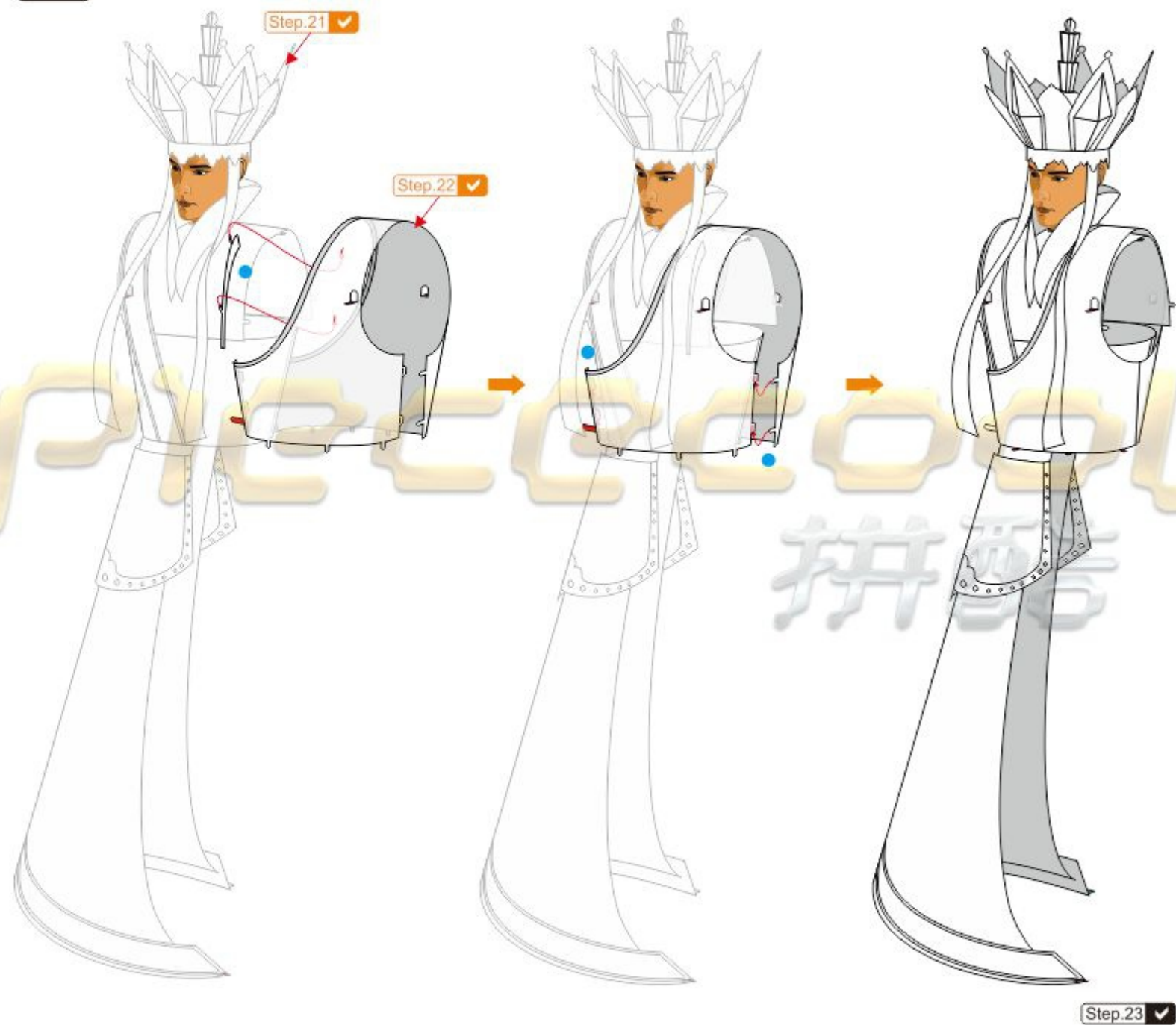

Step 24

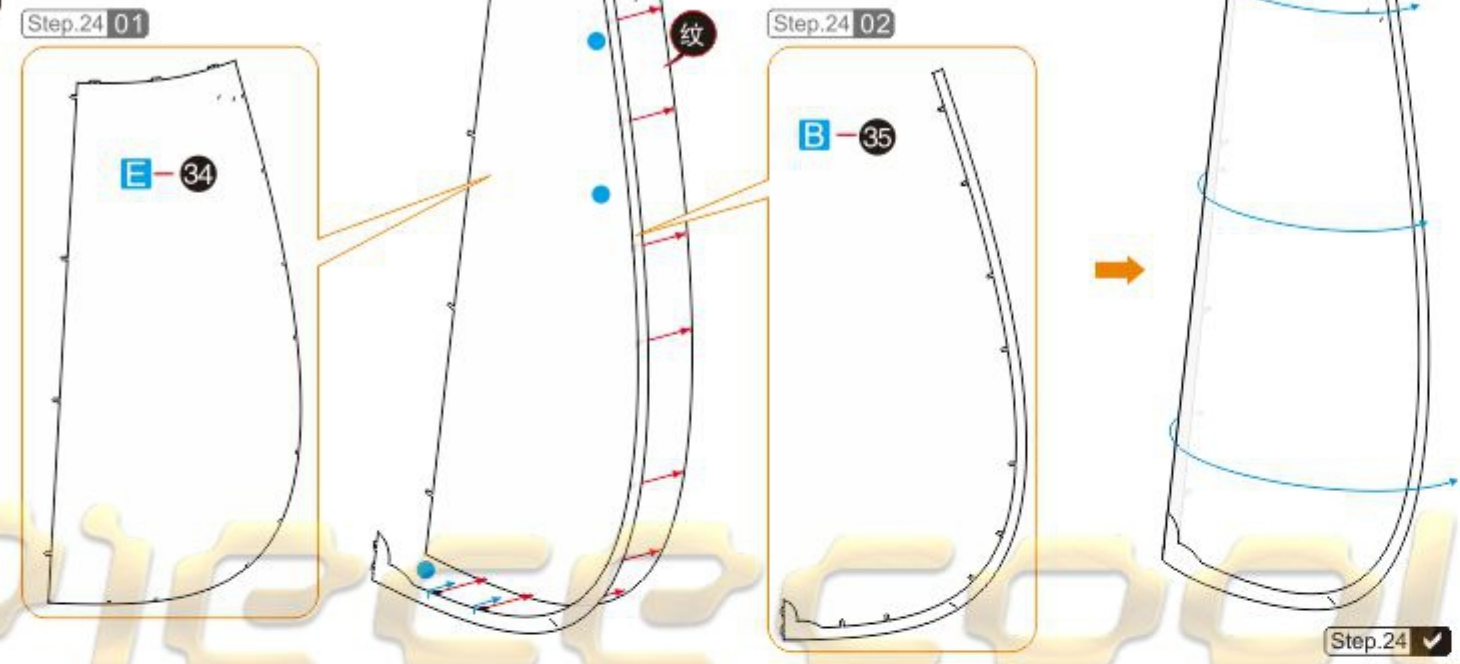

Step 25

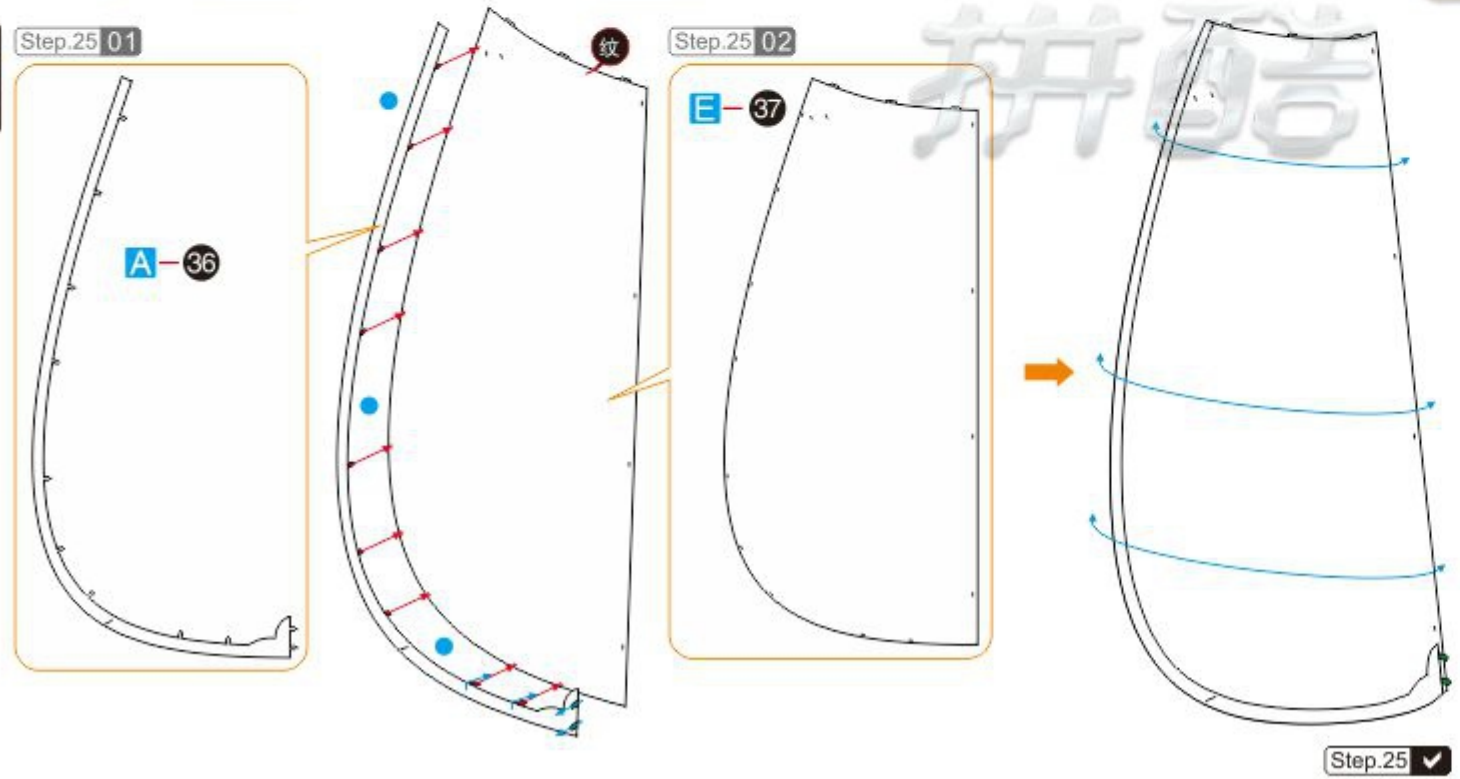

Step 26

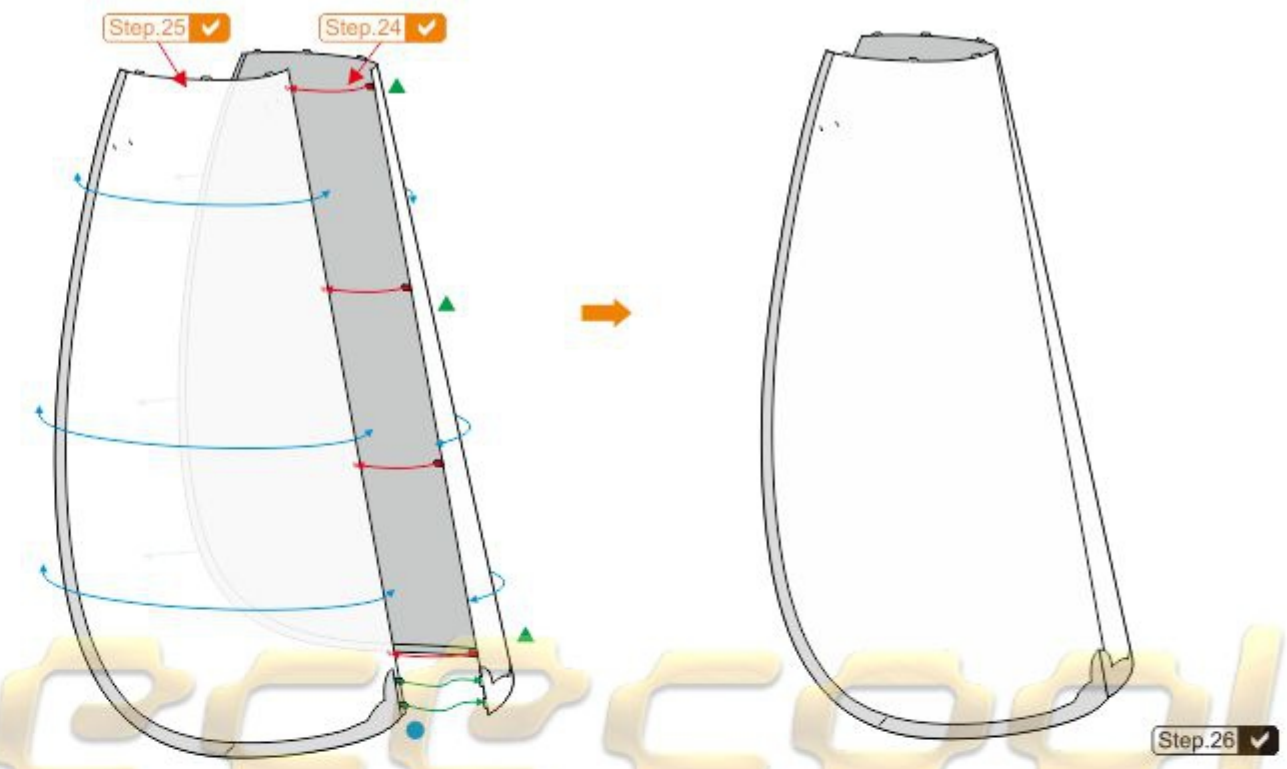

Step 27

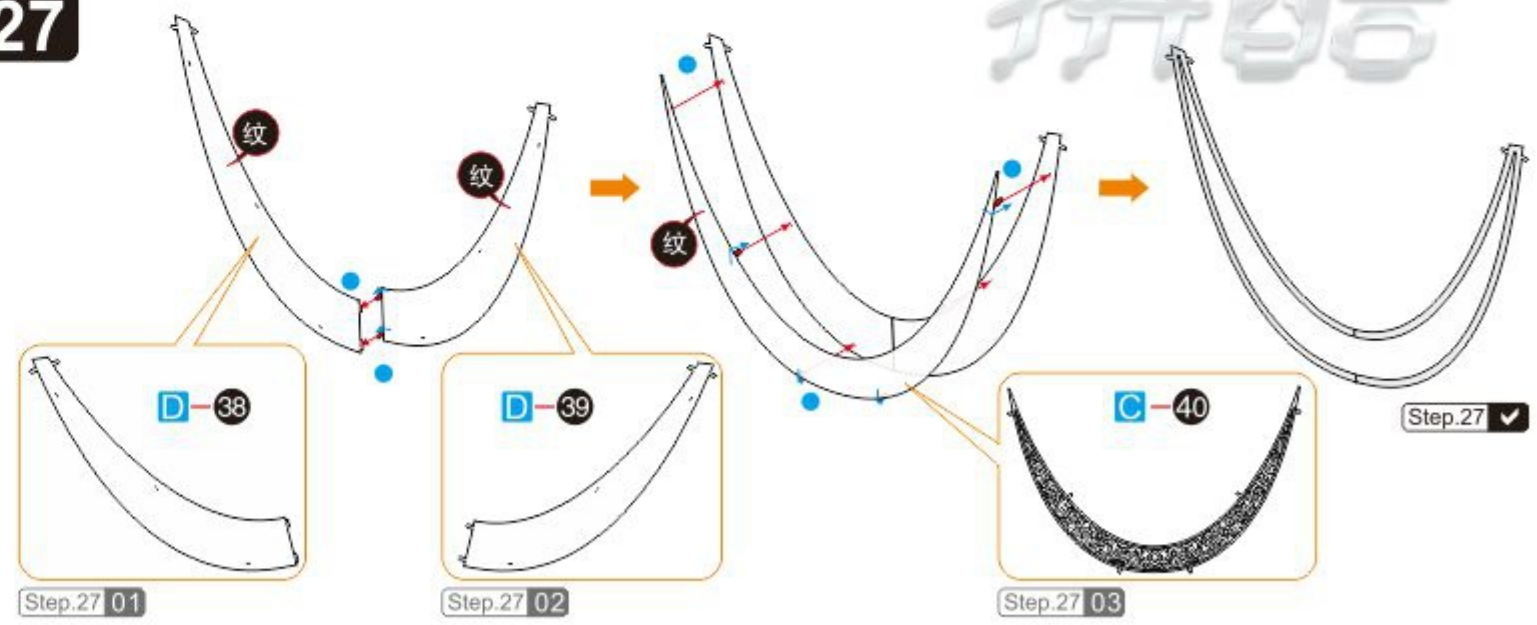

Step
28

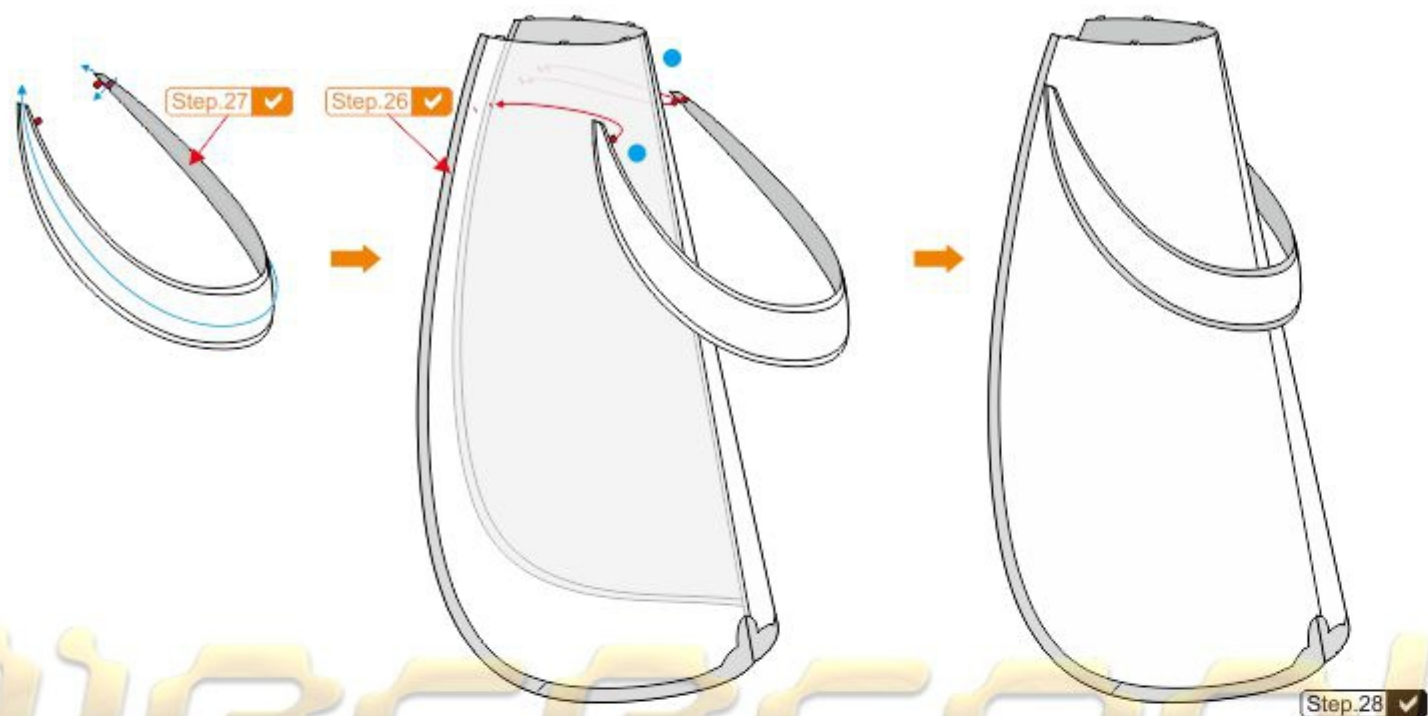

Step
29

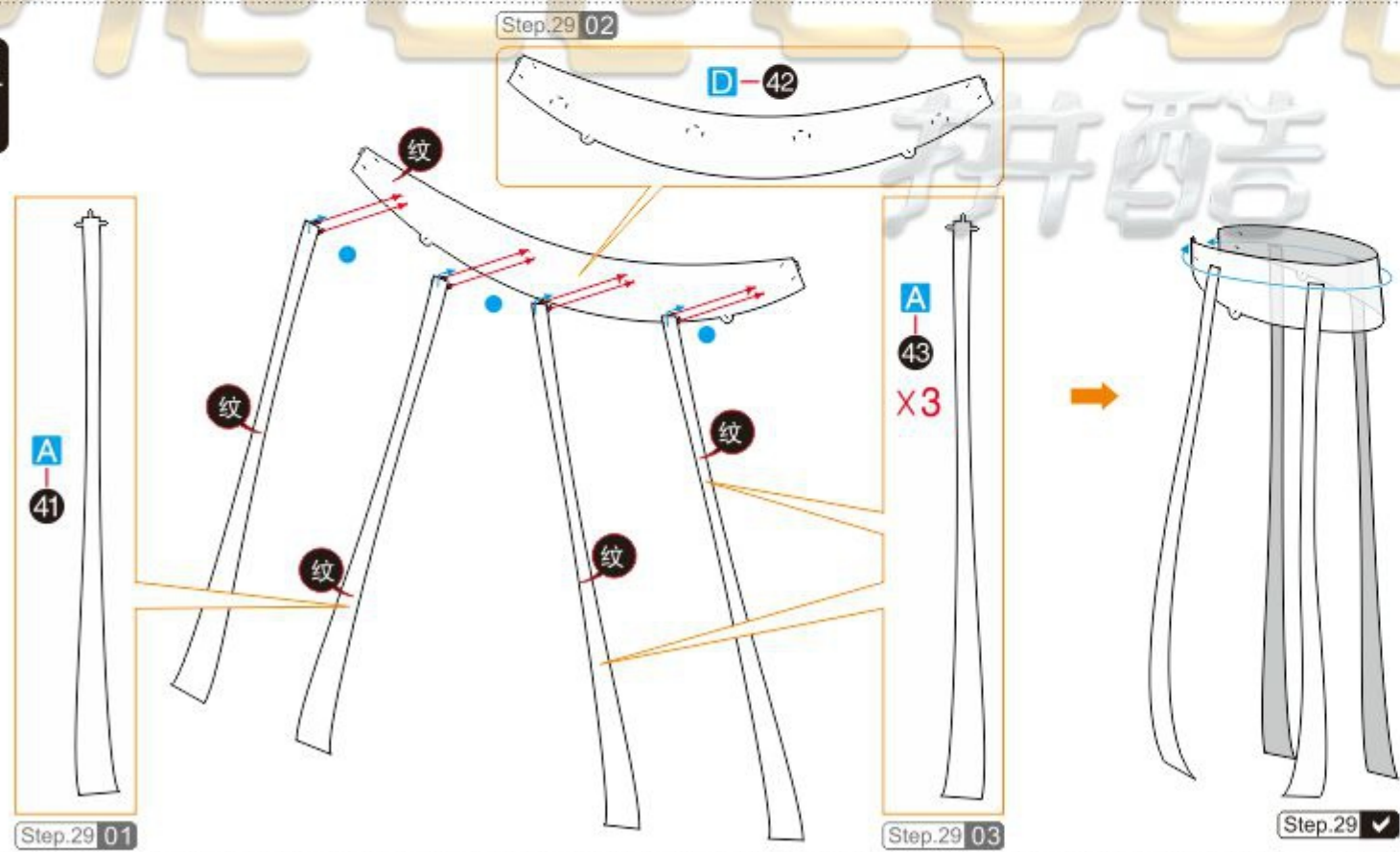

Step
30

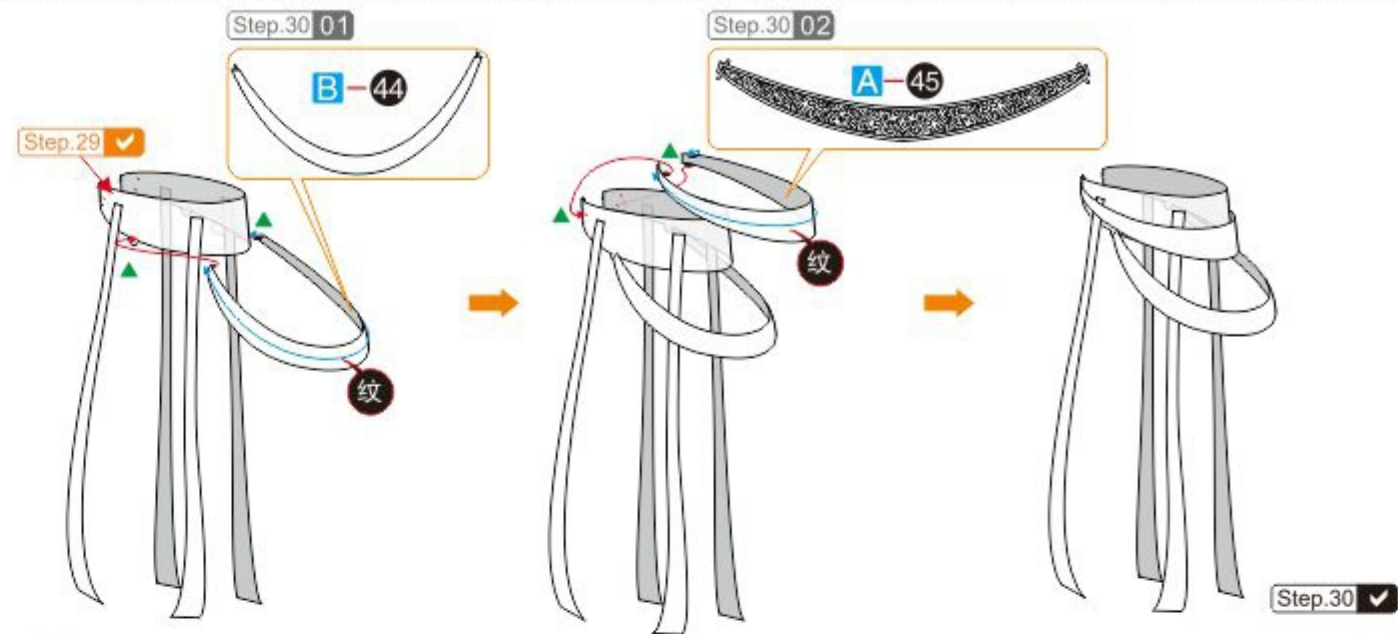

Step
31



Step
32



Step
33



Step 35

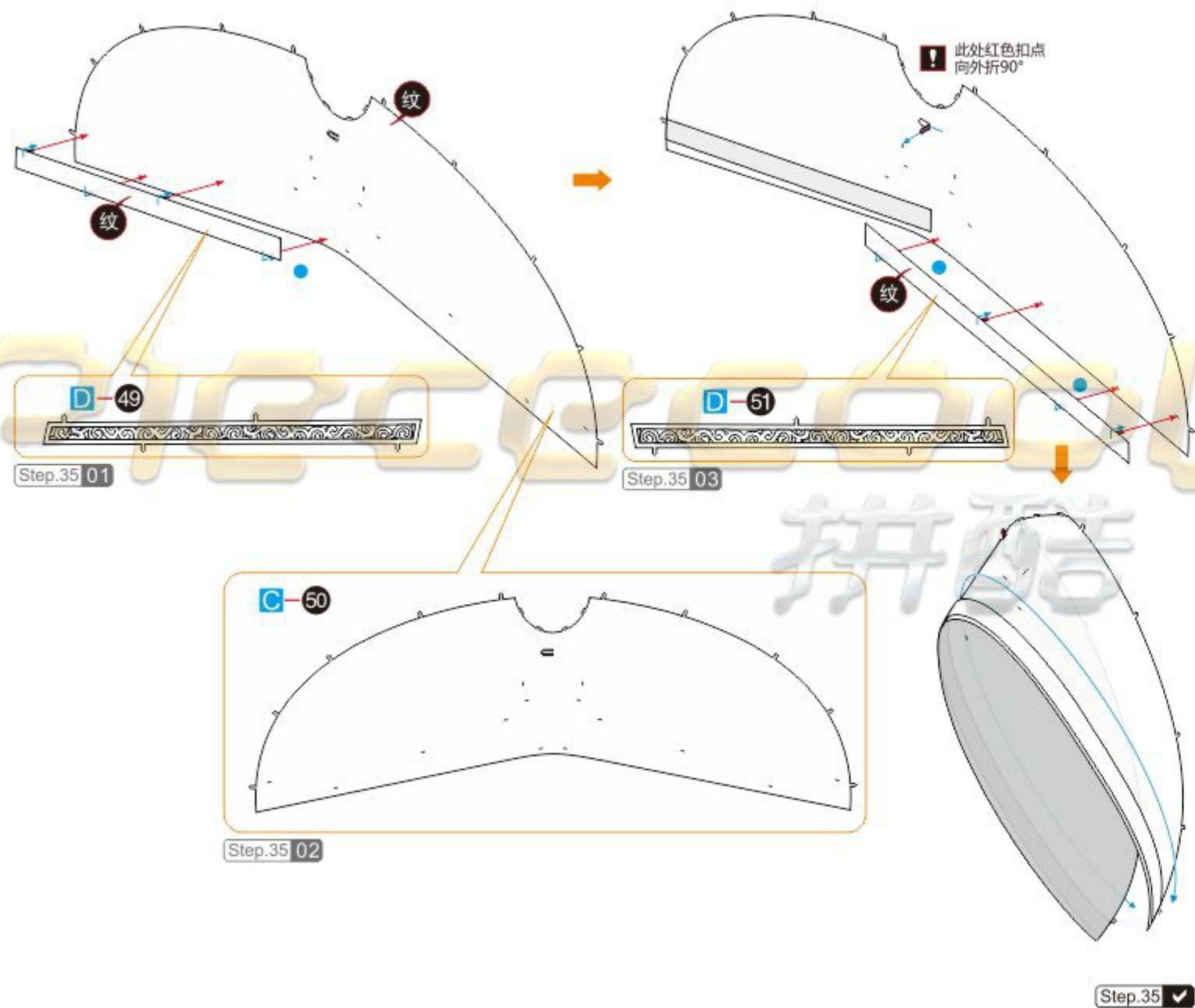

Step 36

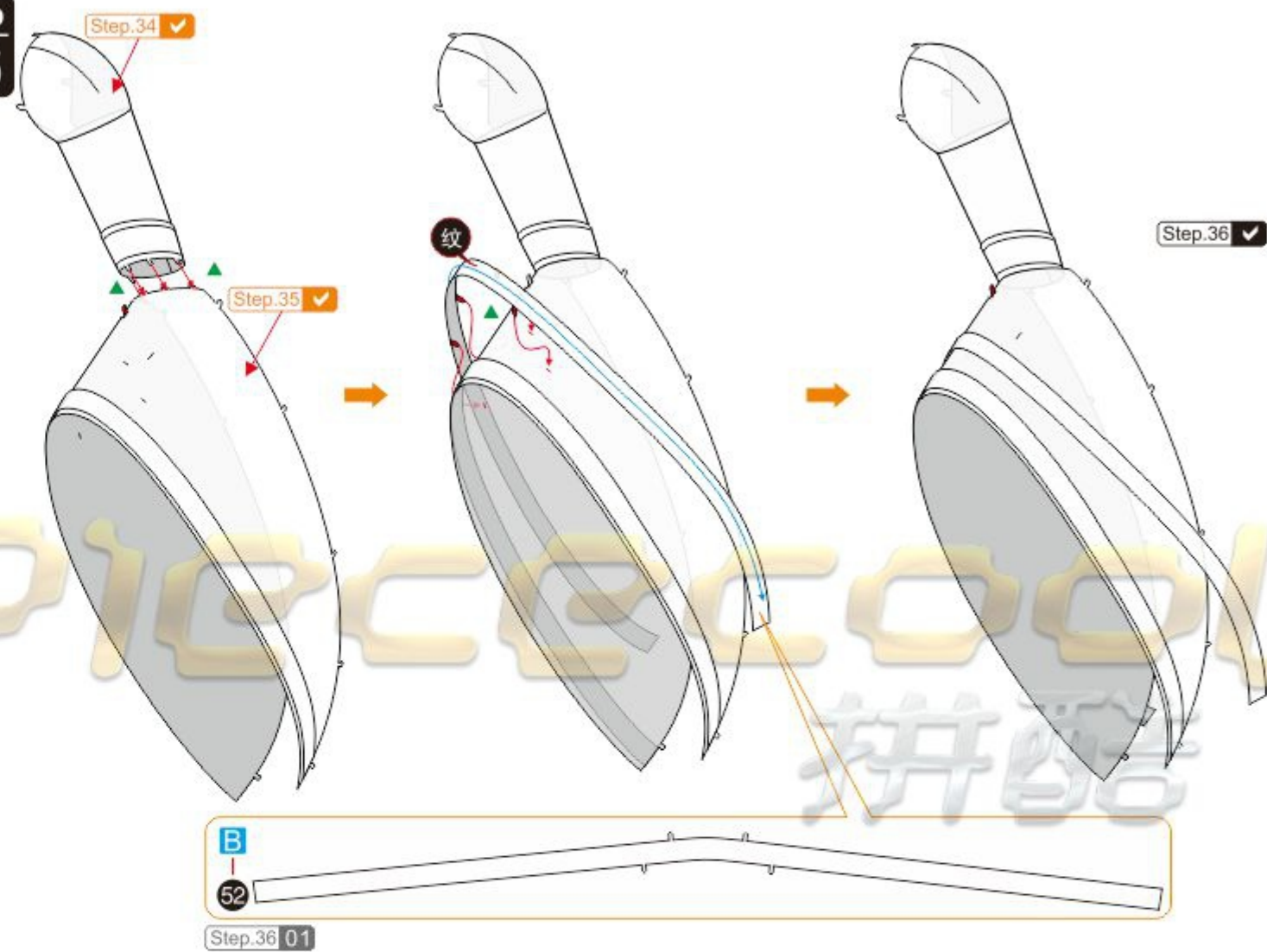

Step 37



Step
38

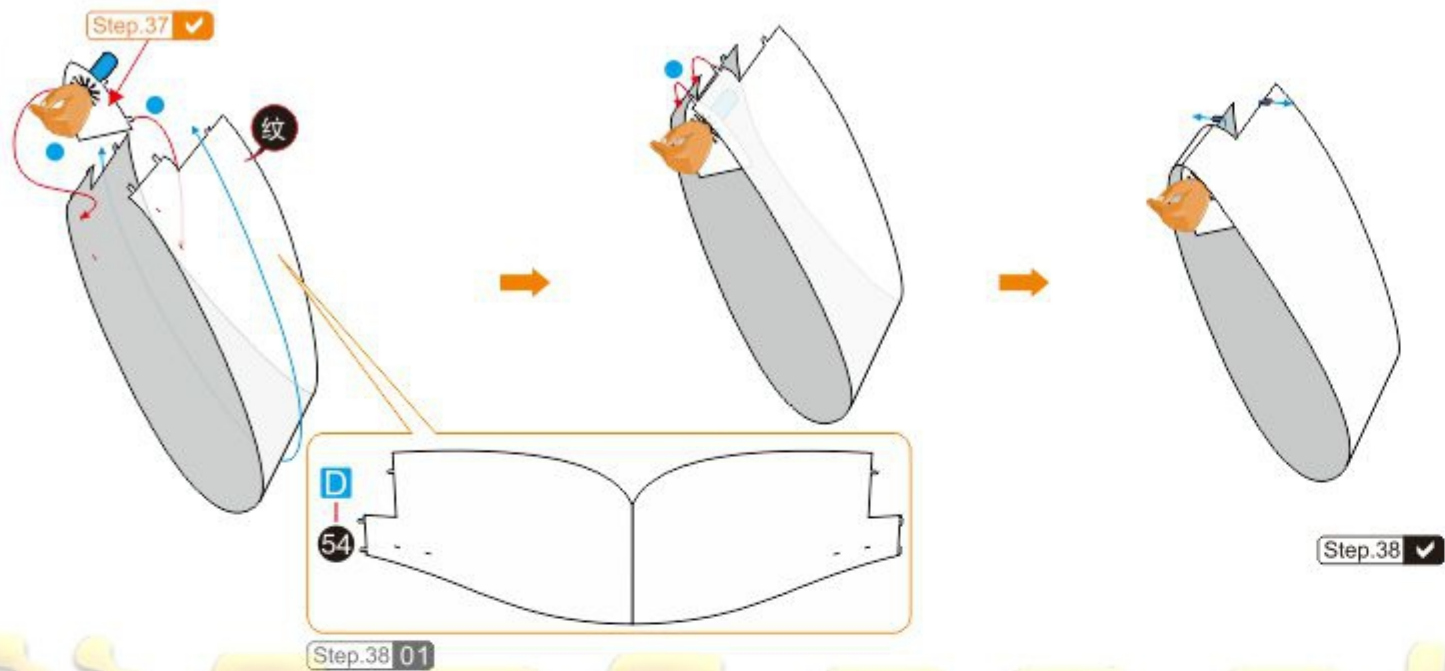

Step
39

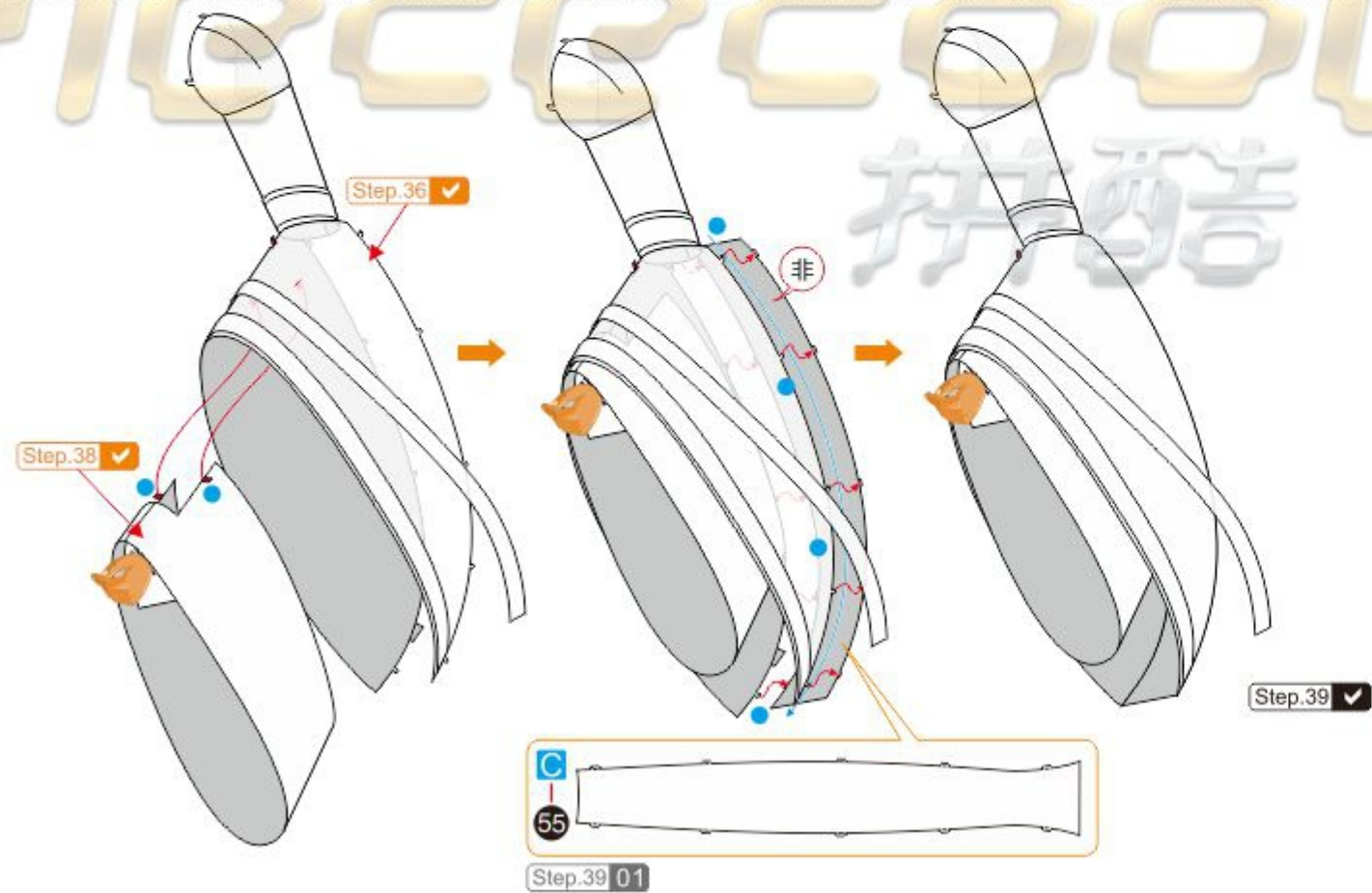

Step
40

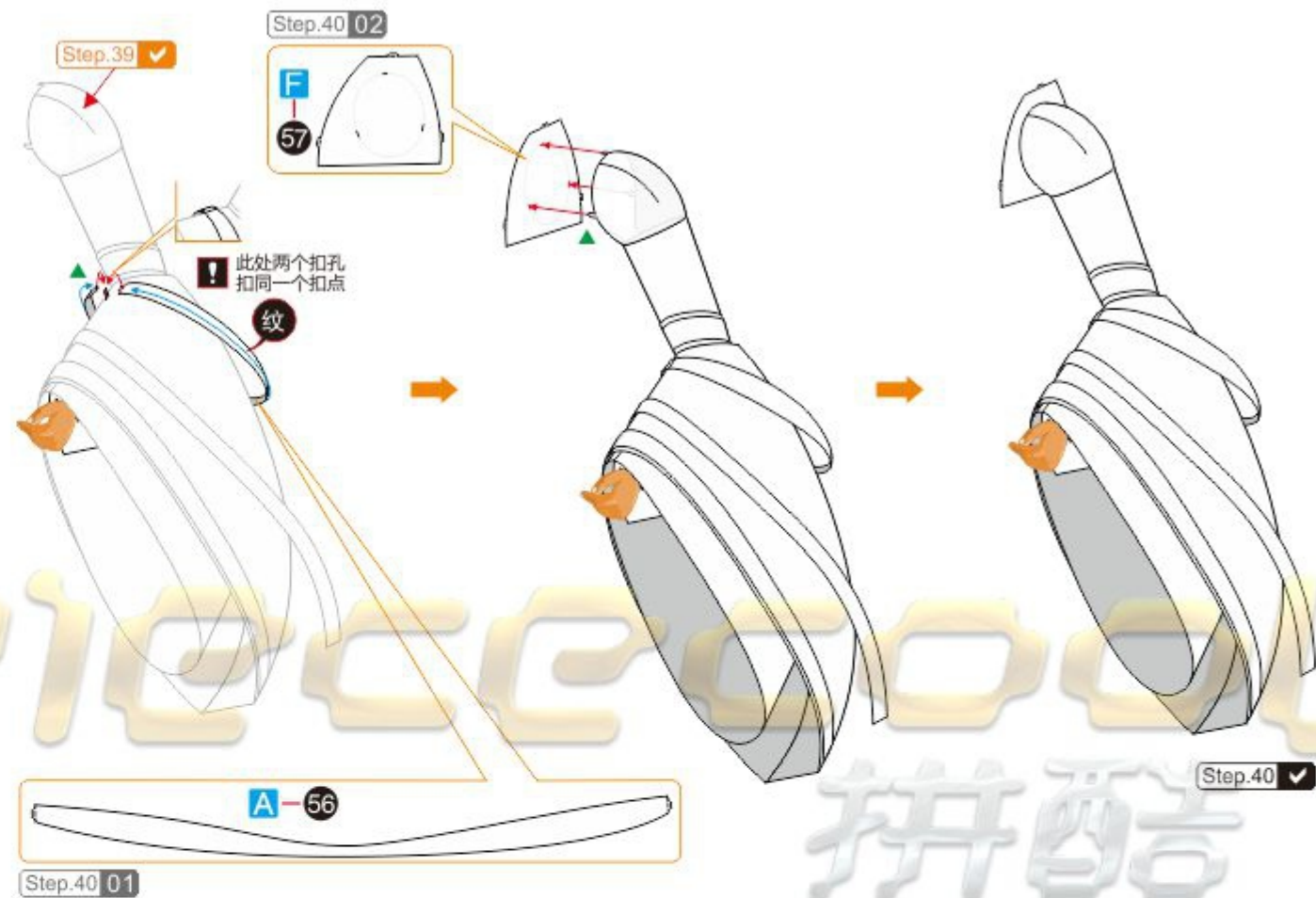

Step
41

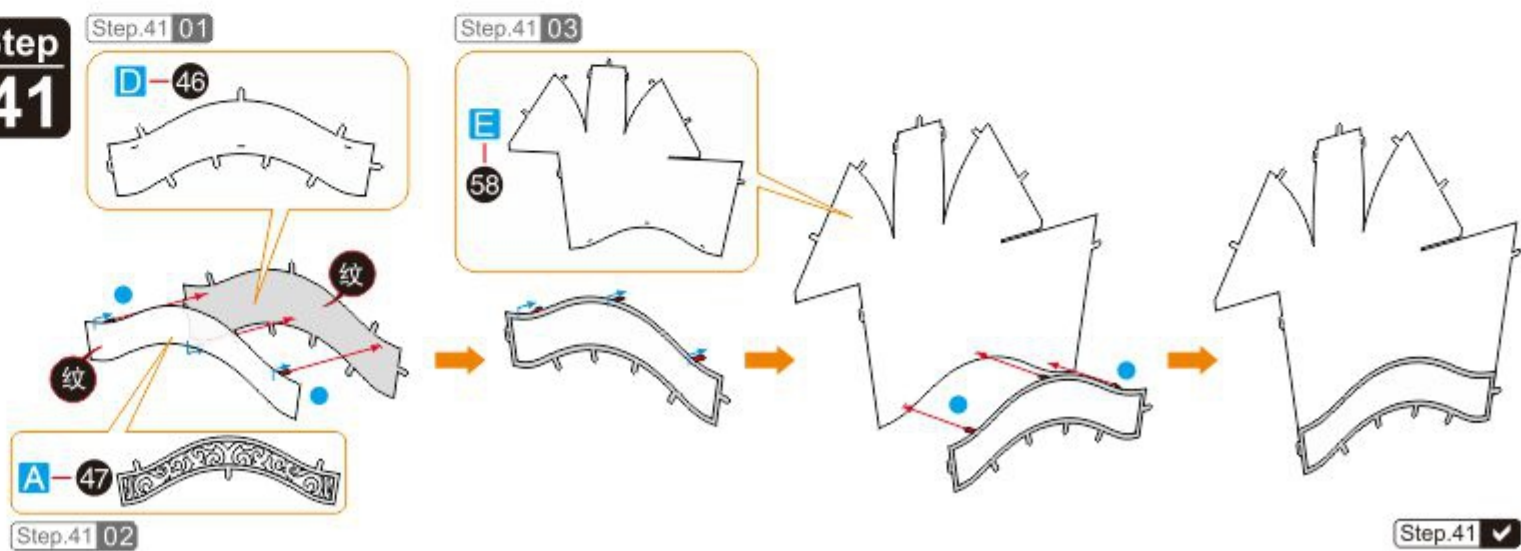

Step
42

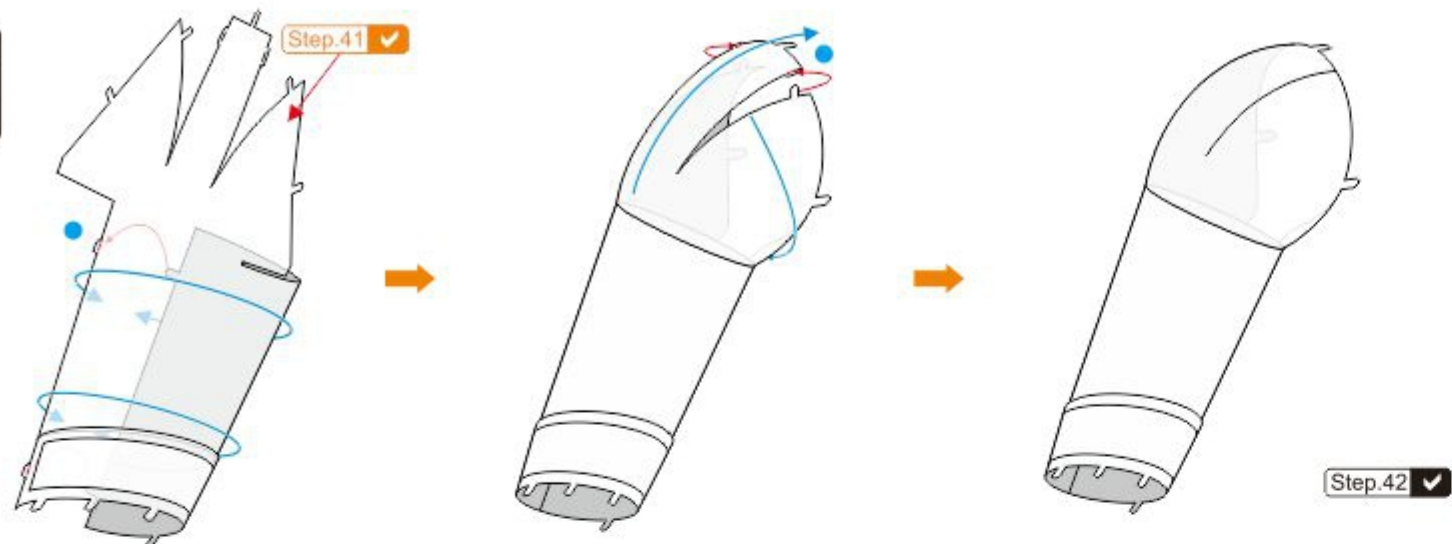

Step
43

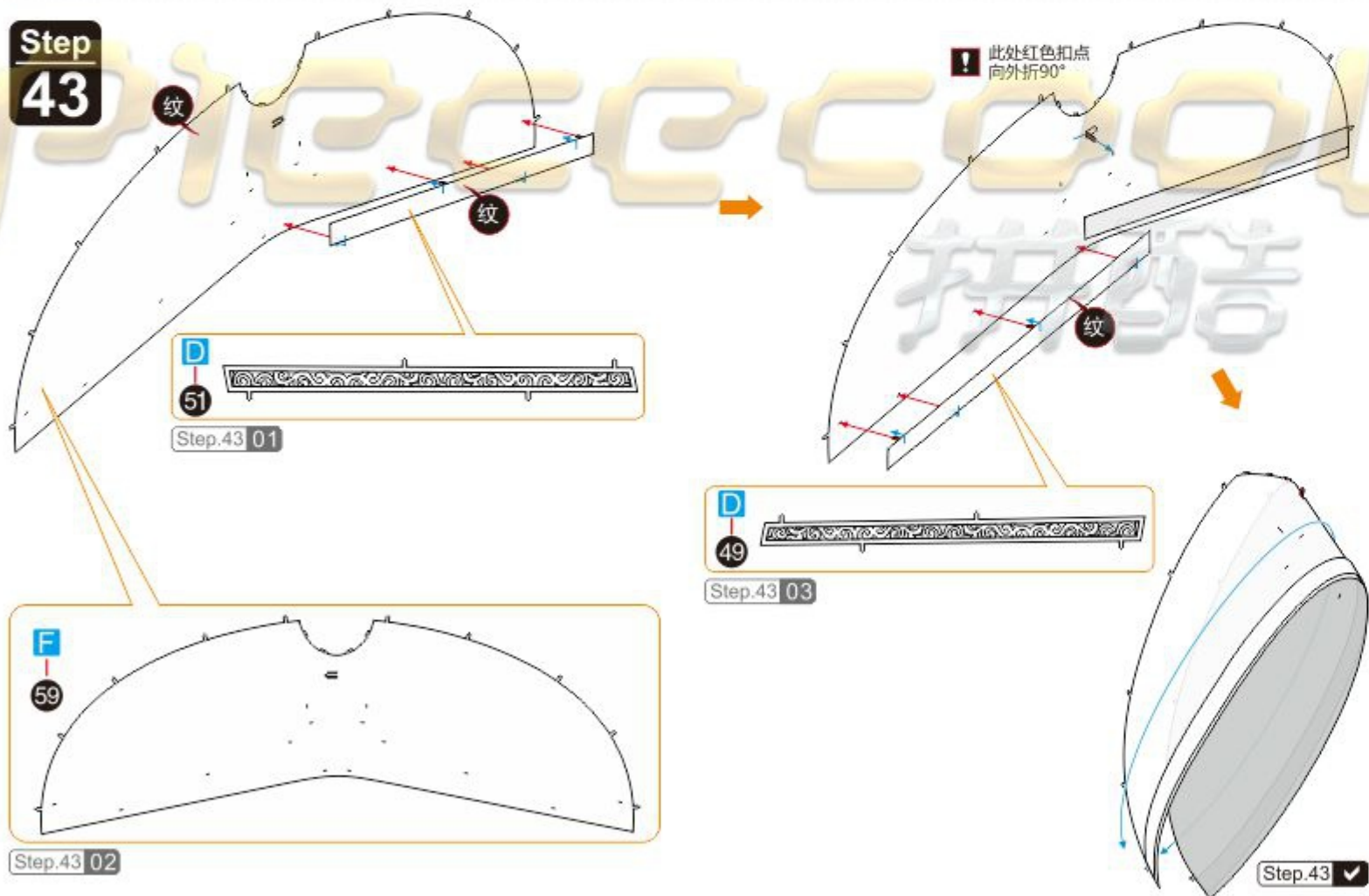

Step
44

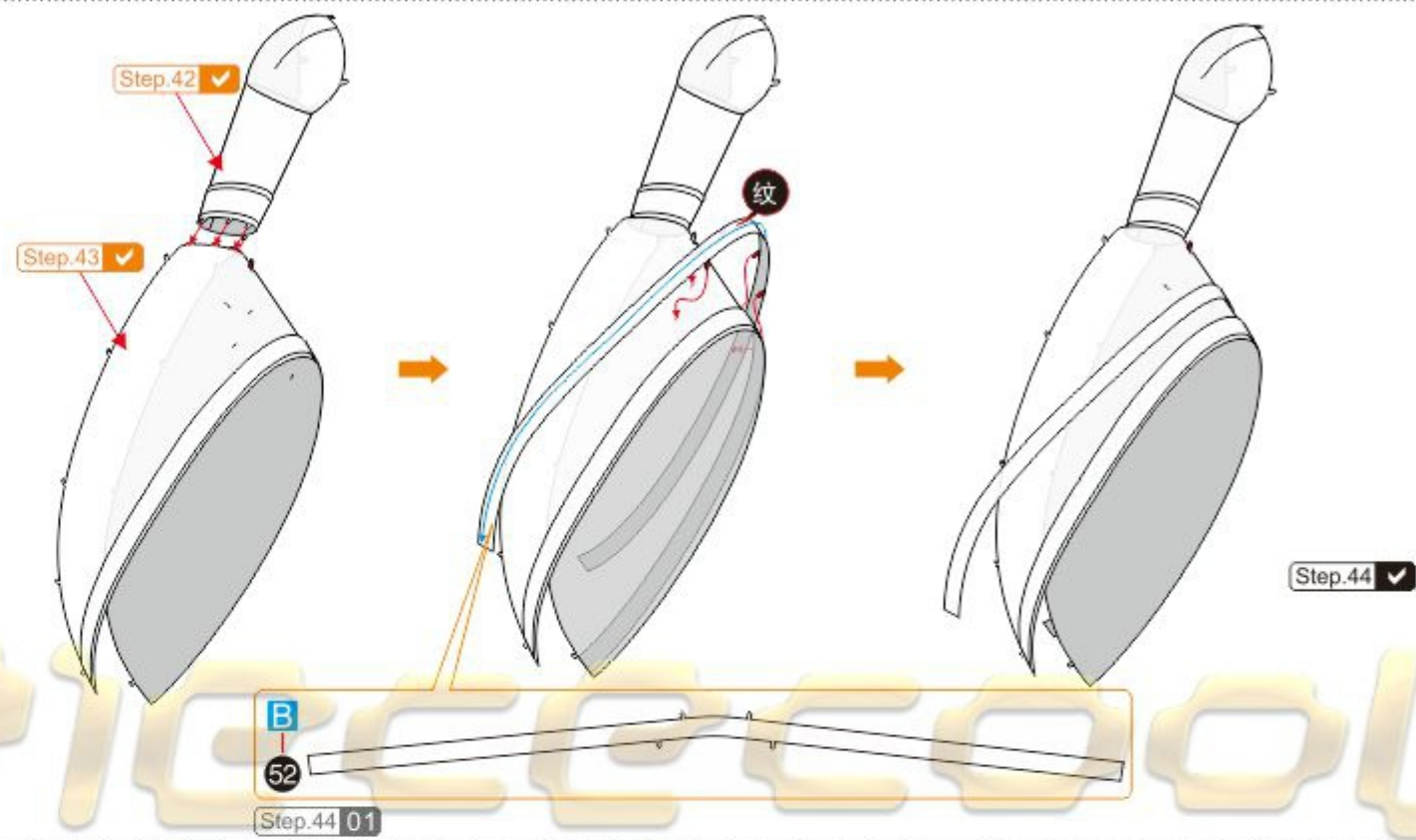

Step
45



Step
46

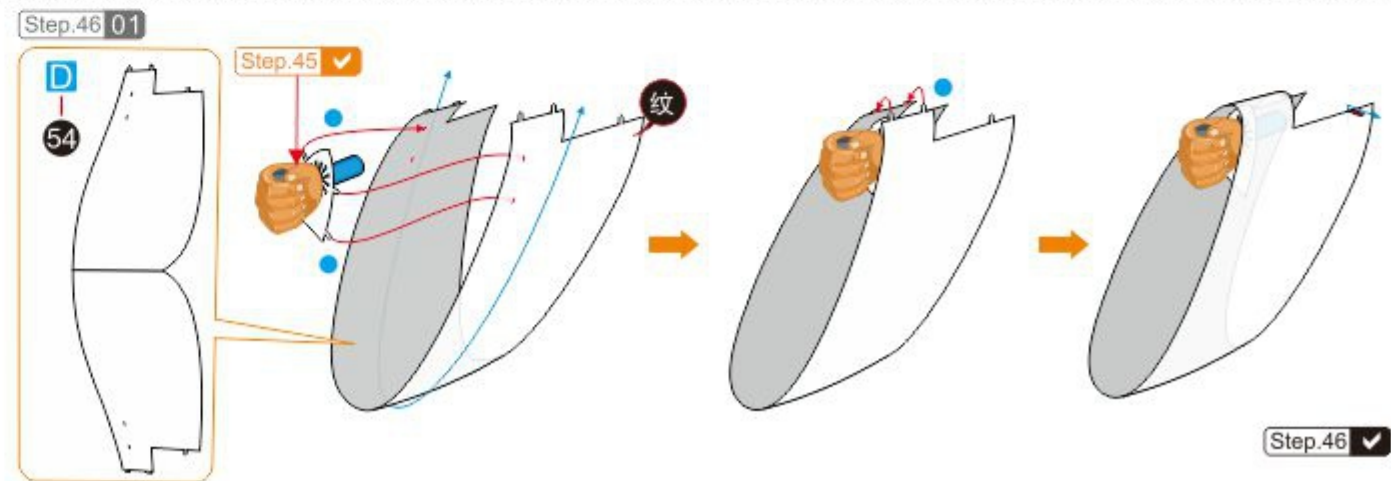

Step
47

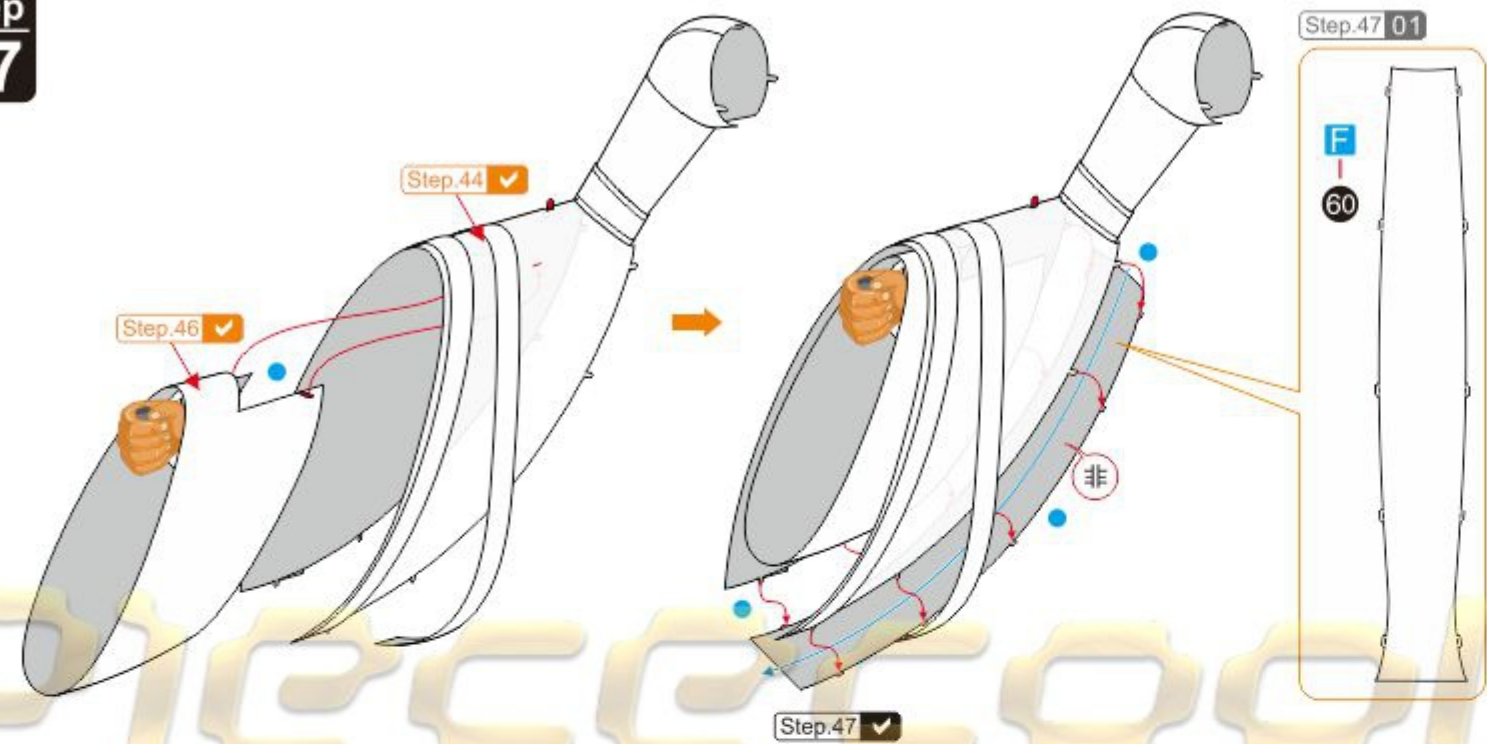

Step
48

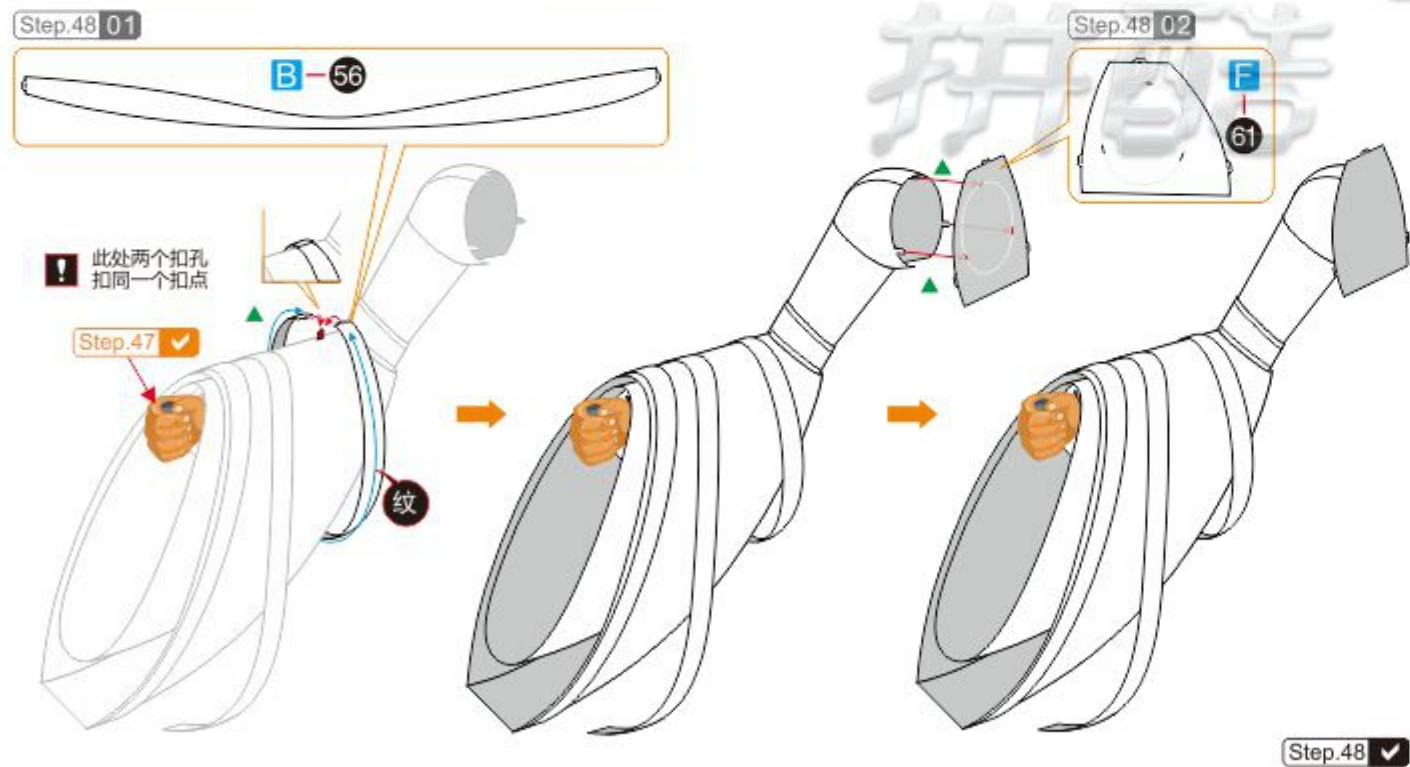

Step
49



Step 50

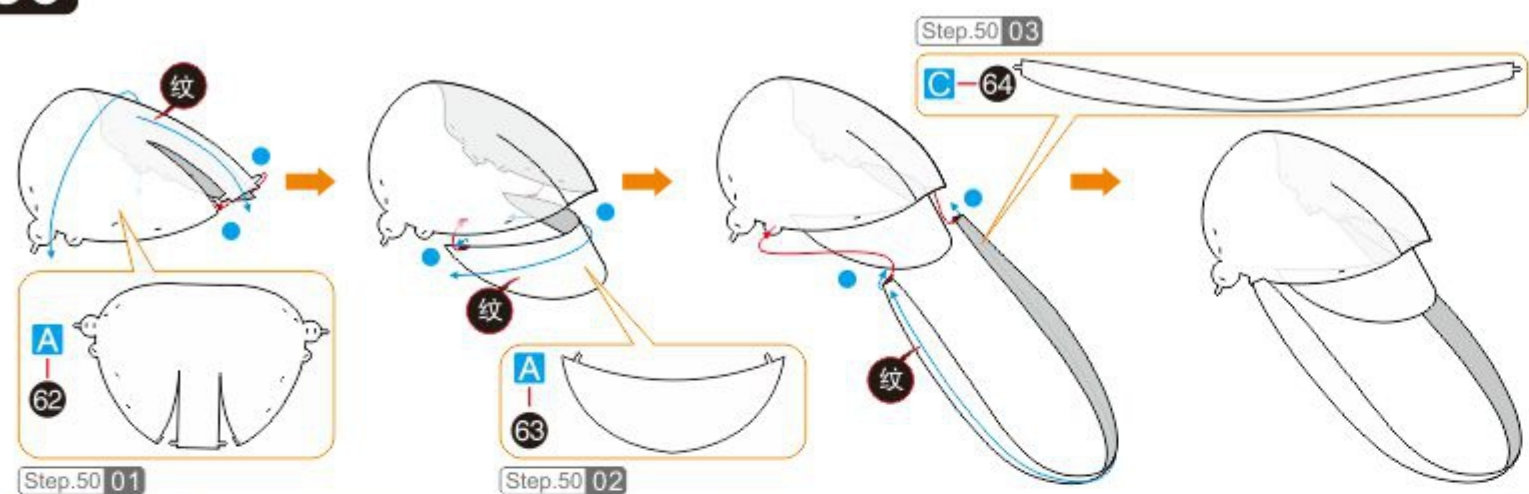

Step 50 ✓

Step 51

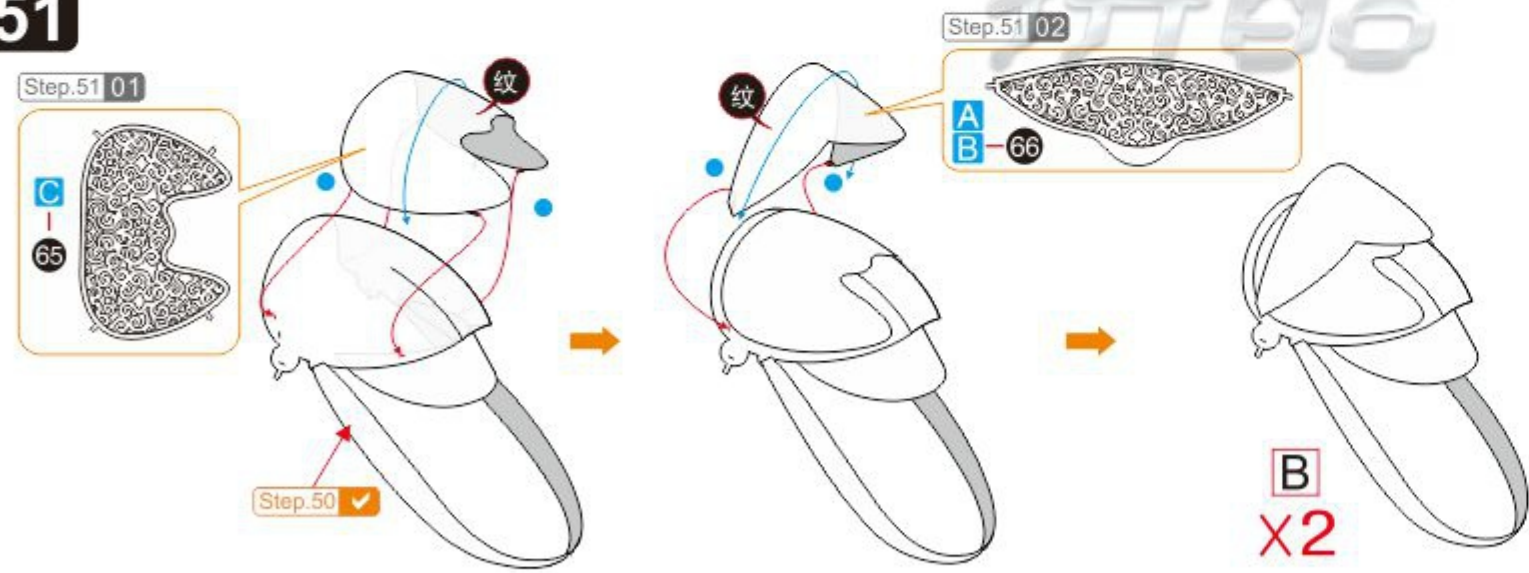

Step 51 ✓

Piececool 拼酷

Step 52

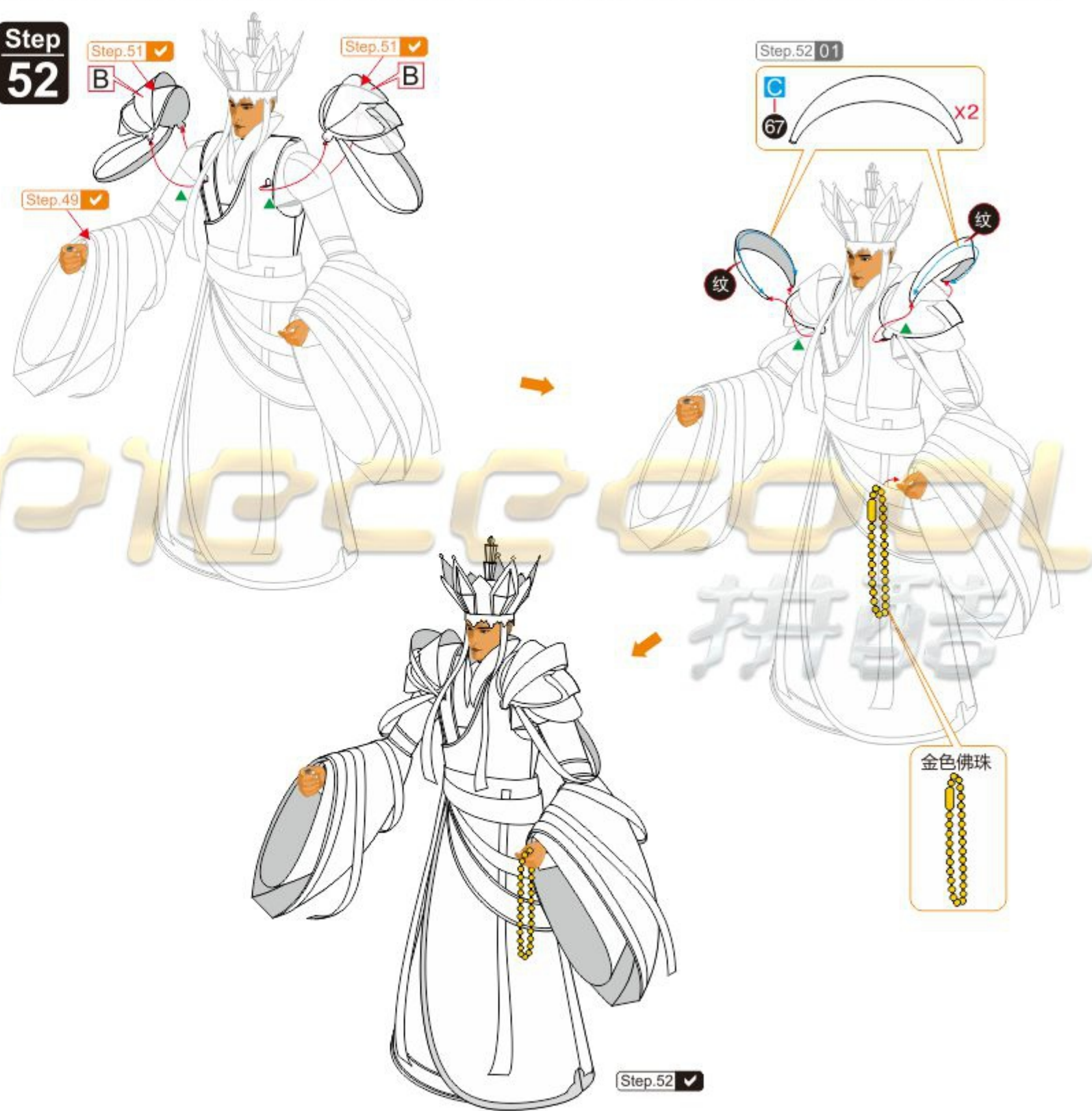

Step 52 ✓

Piececool 拼酷

Step 53

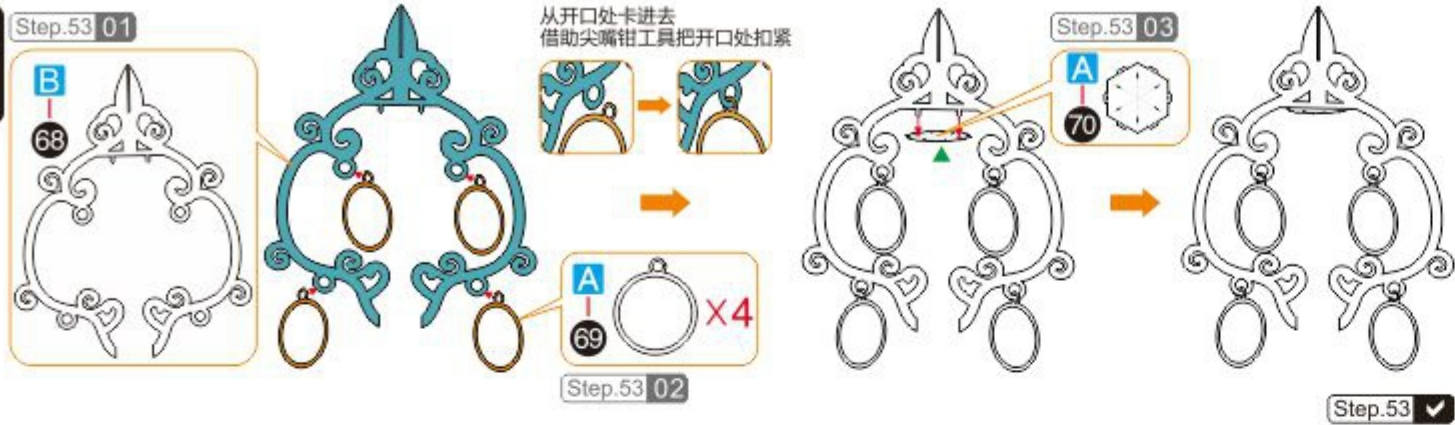

Step 54

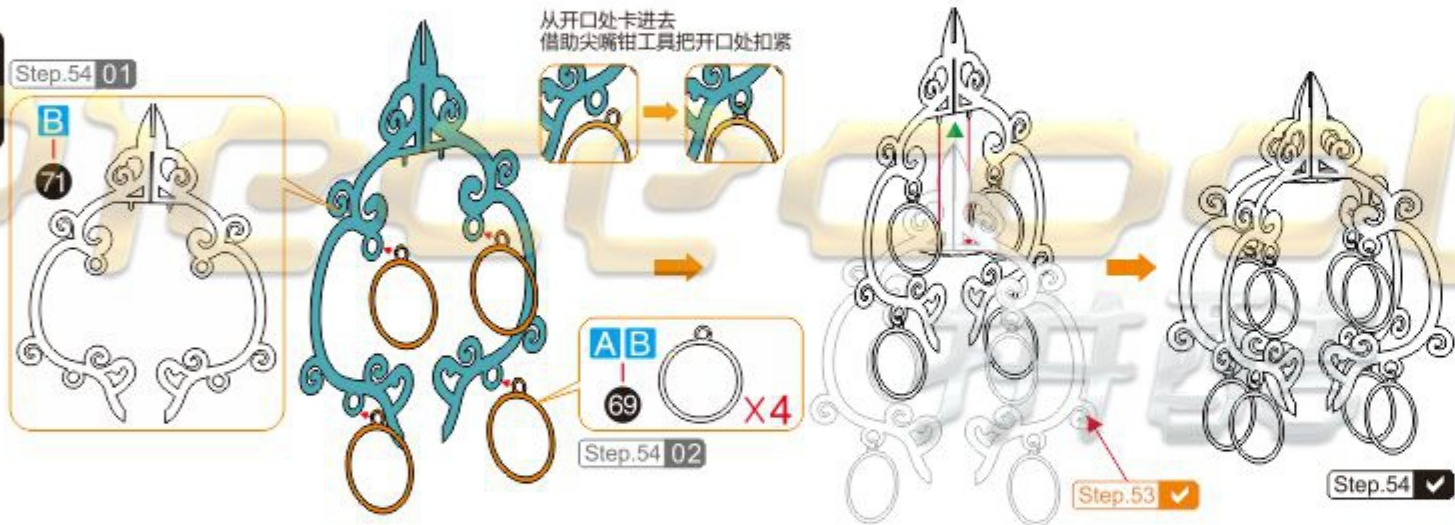

Step 55



Step 56

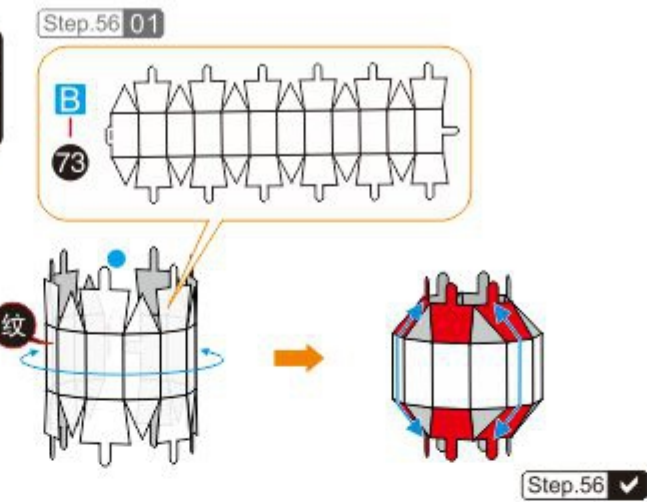

Step 57

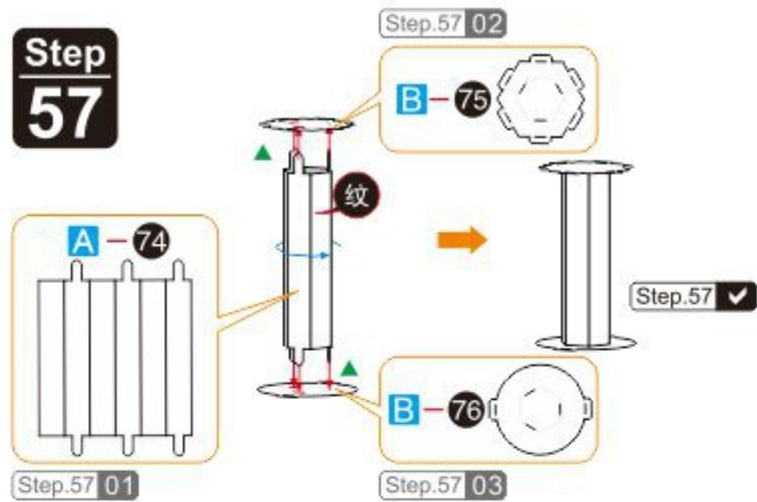

Step 58

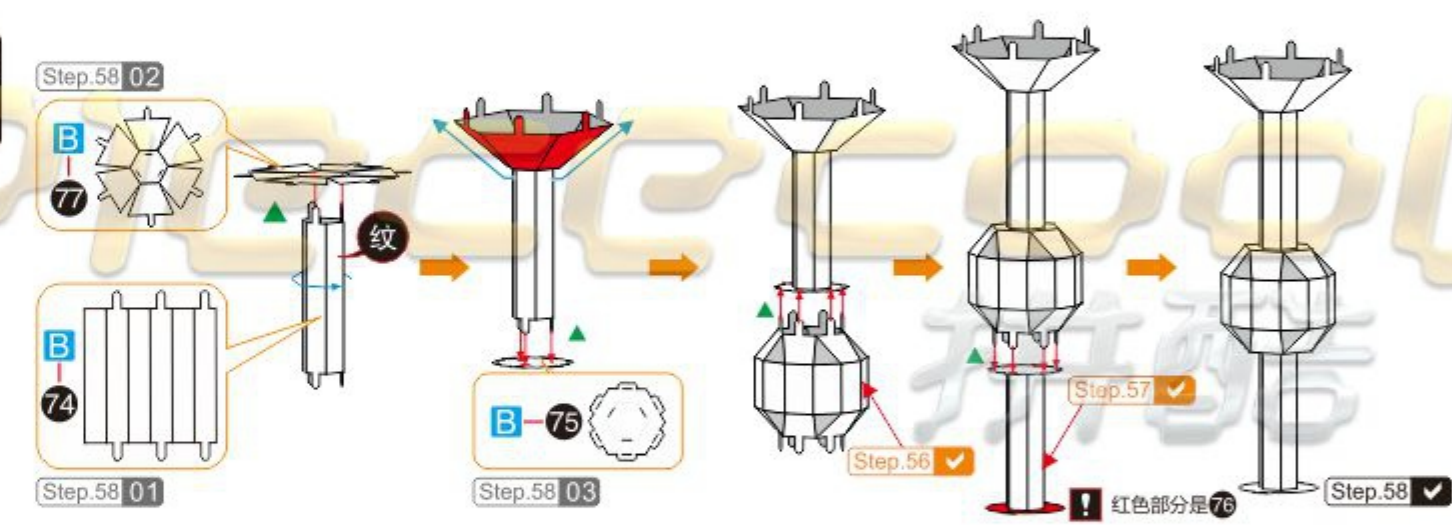

Step 59

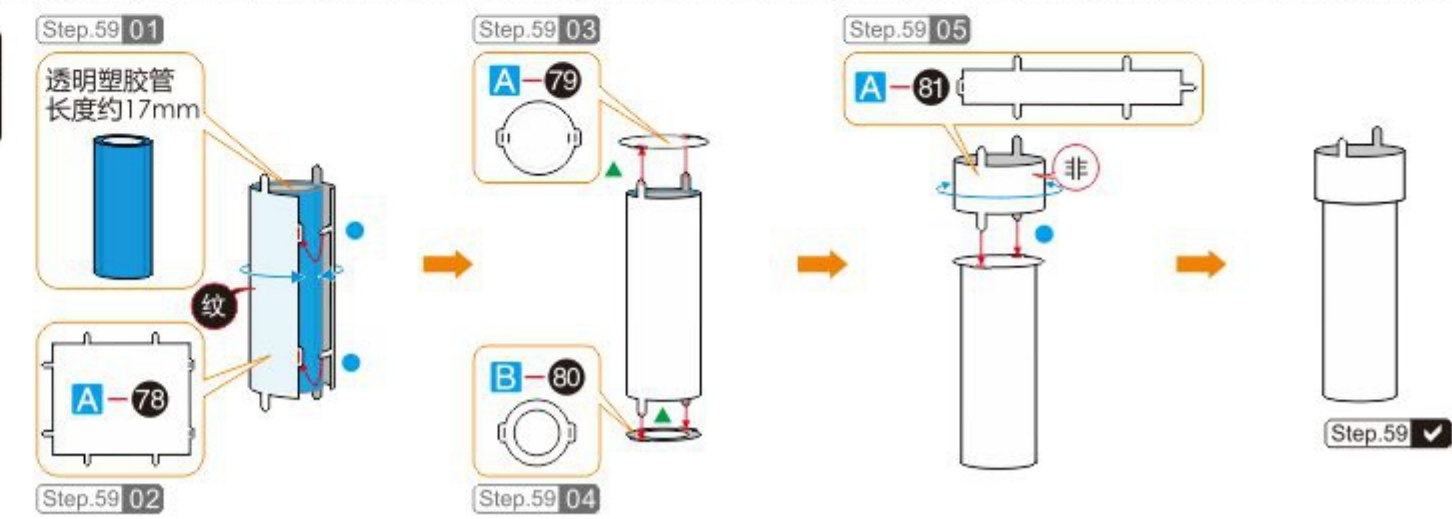

Step
60

Step.60 01

透明塑胶管
长度约10mm

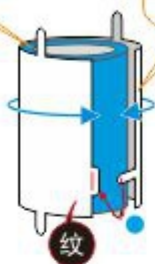

Step.60 02



Step.60 03



Step.60 04

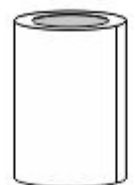

Step.60 ✓

Step
61

金属管

长度约170mm



将金属管从孔中插入

Step.59 ✓



Step.58 ✓

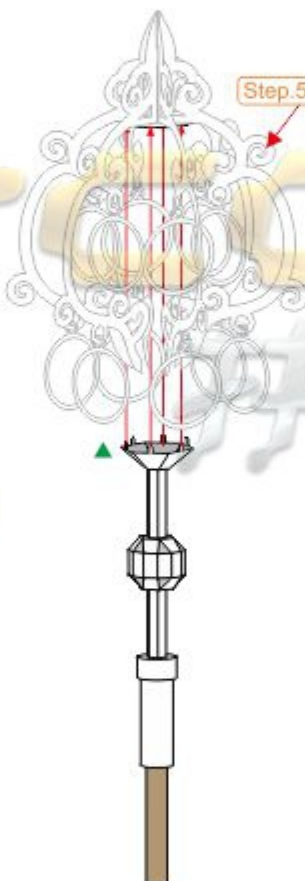

Step.55 ✓

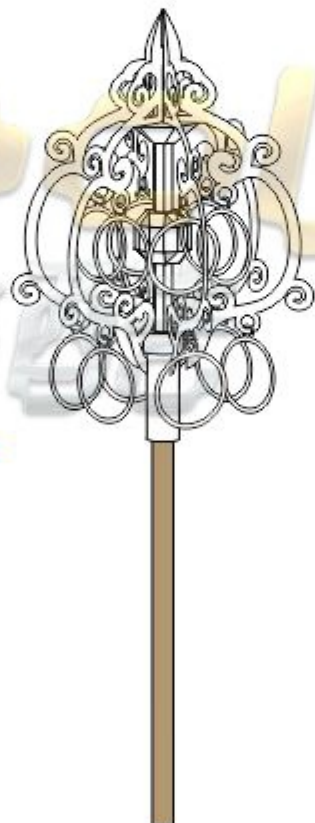

Step.61 ✓

Step
62

Step.61 ✓

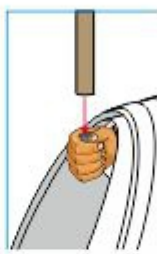

将金属管从手中穿过

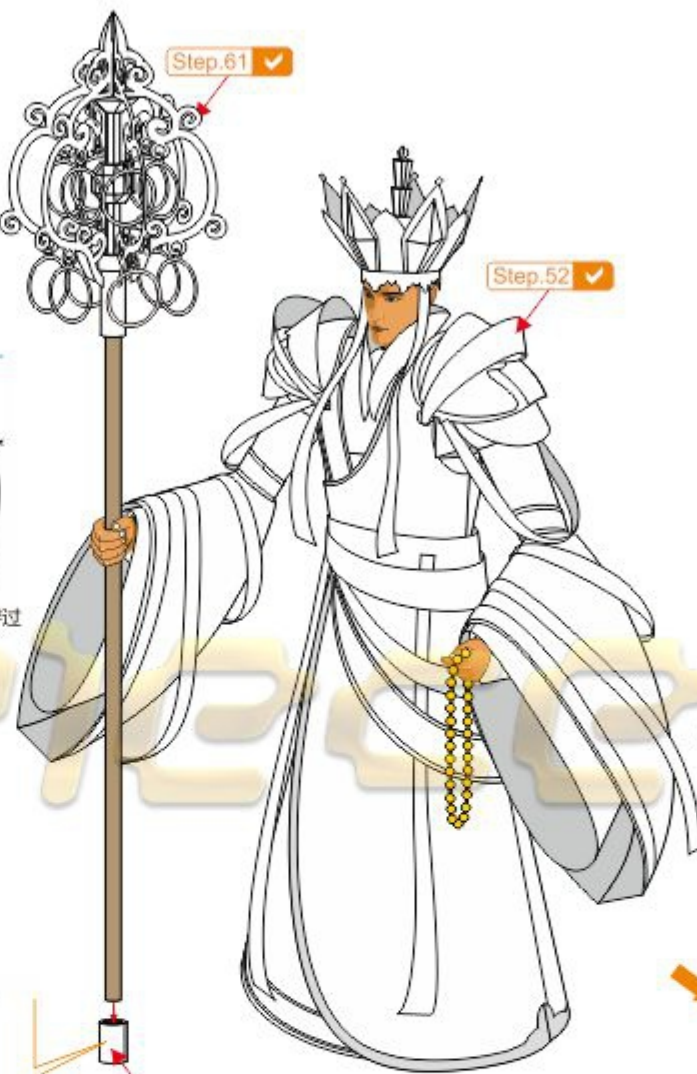

Step.52 ✓

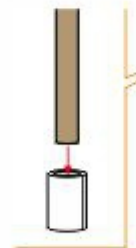

将金属管从孔中插入

Step.60 ✓



Step.62 ✓

东莞市微石塑胶金属科技有限公司 出品
WIST PLASTIC & METAL TECHNOLOGY LIMITED
地址：广东省东莞市寮步镇向西工业区村口街2号 邮编：523408
电子邮箱：kf@wist-group.com
服务热线：0769-8119 2243

© Wist Plastic & Metal Technology Limited. All rights reserved.

P104.SMS.20180517.A1