



网状高跟凉鞋 HIGH HEELED SANDAL P030-G

拼装说明书

拼装提示 TIPS:

本产品采用扣点与扣位卡扣拼折的拼装方式，未发生拼装损坏，无需使用胶水 

建议购买并使用拼酷正品拼装工具， T-SKQ05 水口钳  ， T-JZQ05 尖嘴钳  ， 拼装更省时省力，作品更精细美观！

请参照包装内说明书进行拼装，请勿反复拼折金属零件，以免损坏。

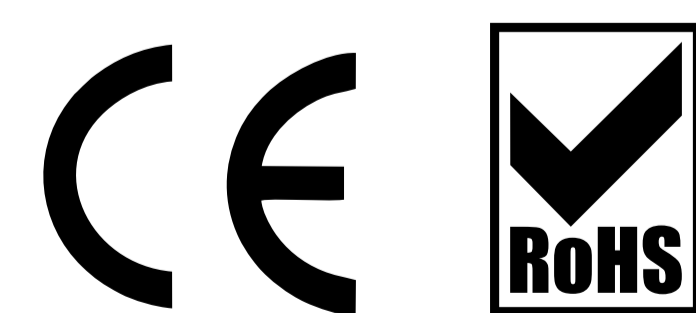

AGES 14+

本产品为金属制品，14岁以下需由成人陪同完成！

30

piececool
拼酷

网状高跟鞋

HIGH HEELED SANDAL

挑战星级 Difficulty Level



P030-G

DIY拼装，动手动脑，乐趣多多，
品类多样，寓意丰富，
收藏、送礼两相宜！

DIY 手工艺术

ORIGINAL DESIGN
原创设计

METAL CRAFT 金属工艺

ASSEMBLY MODEL 拼装模型

HOME ARTWORK
家居陈列饰品

FUNNY GIFTS
创意礼品



综合类别

拼酷金属拼装模型，炫酷的金属材质，精密的空间结构，
意想不到的四维酷爽大挑战，让您享受玩家级的拼装与收藏体验！

网状高跟鞋 拼酷 HIGH HEELED SANDAL

piececool 拼酷

P030

组装基本步骤示意图

● 插入扣孔，平折 90°

▲ 插入扣孔，旋转 90°

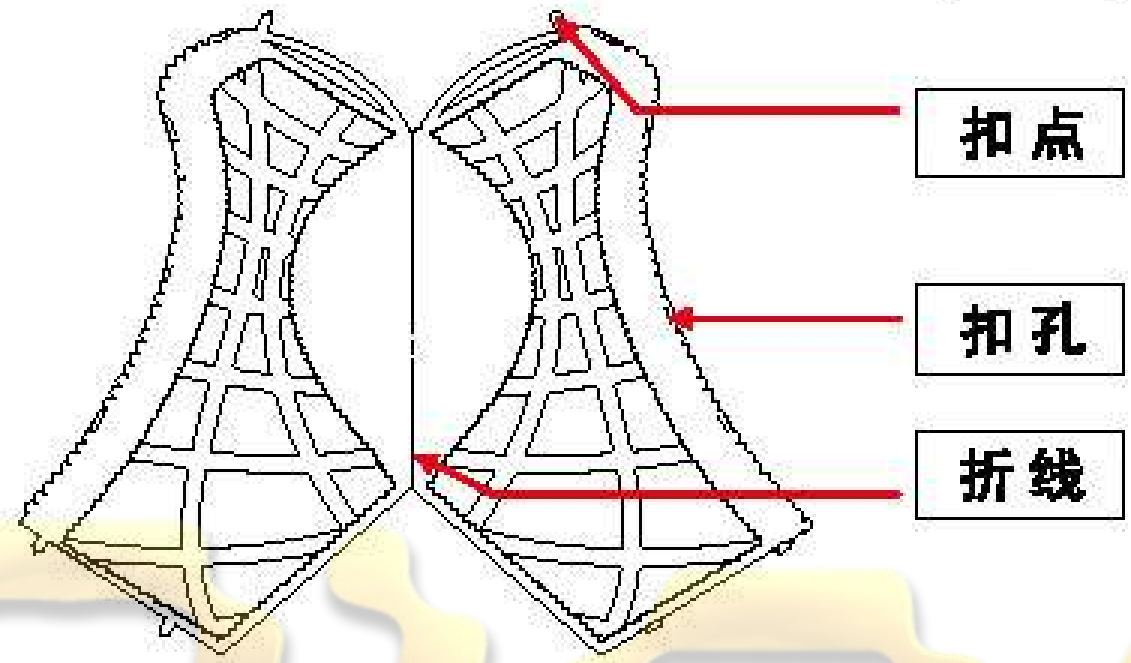
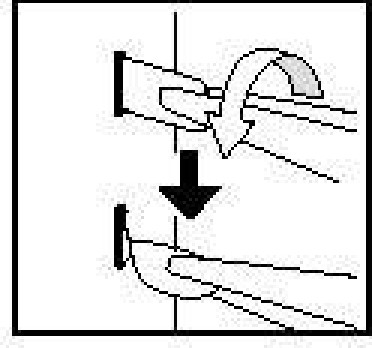
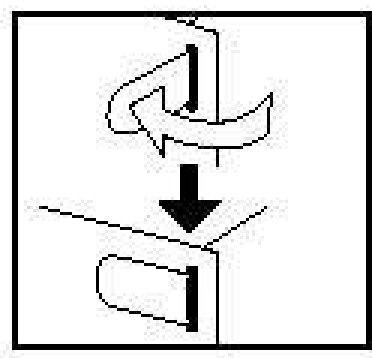

拼装工具



金属部件

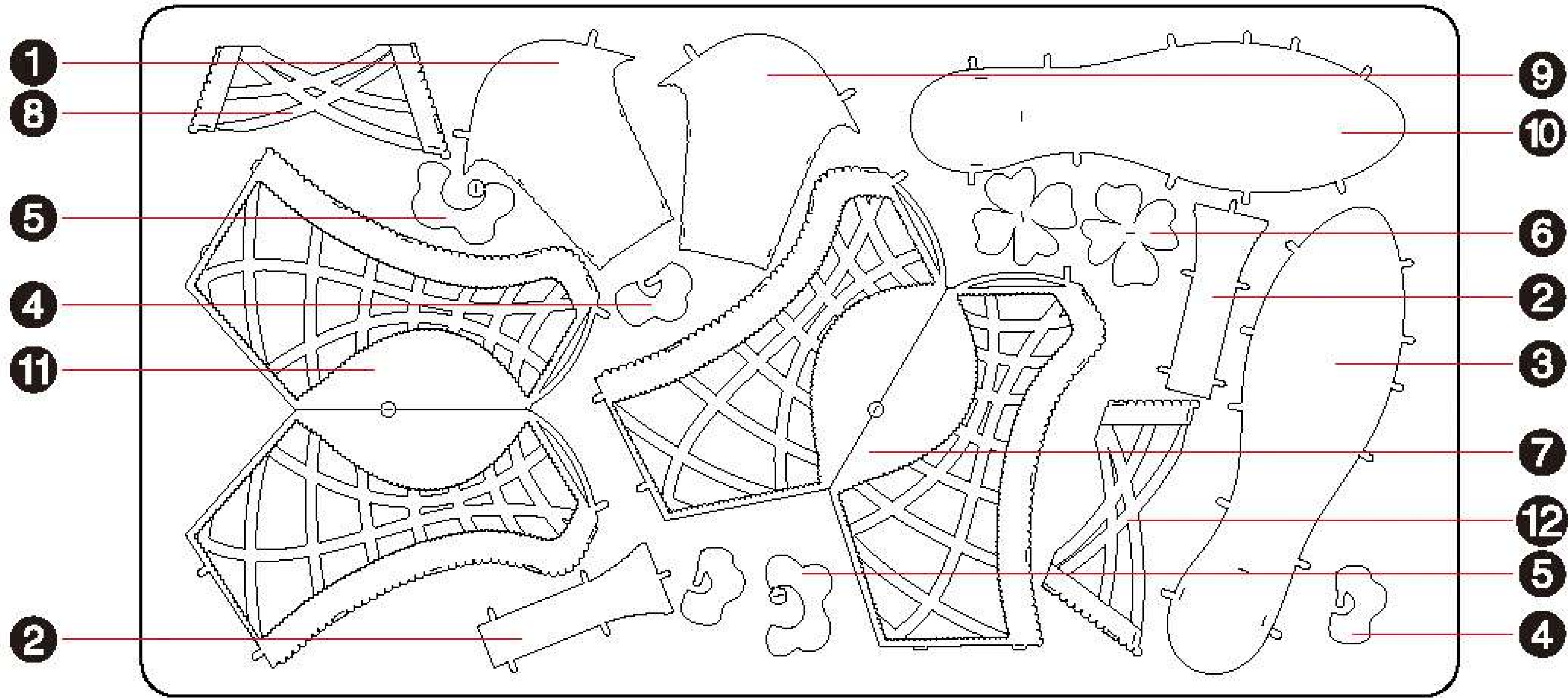

⚠ 请小心处理金属边料，以防划伤

拼装步骤

Step 1

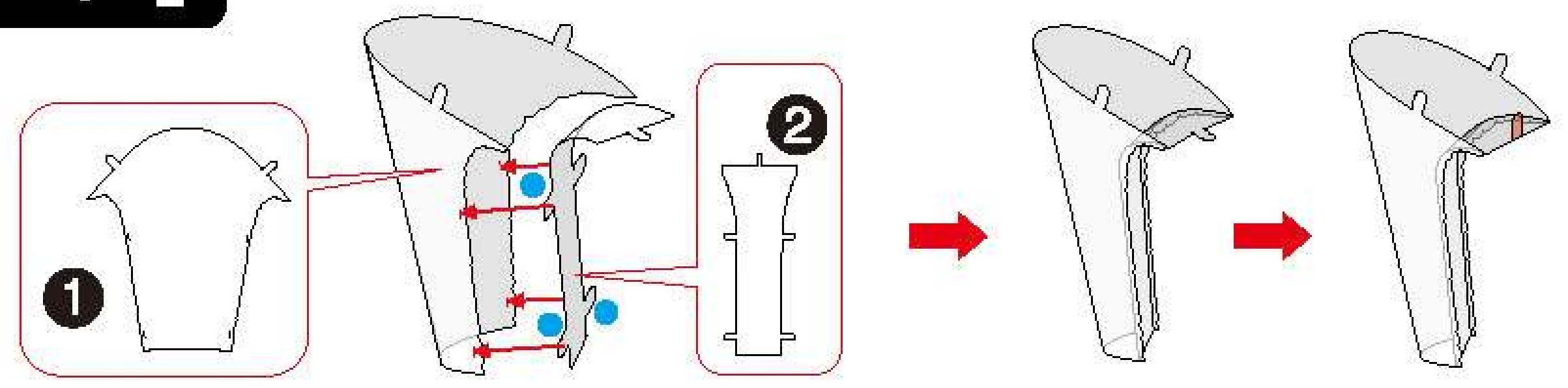

Step 2

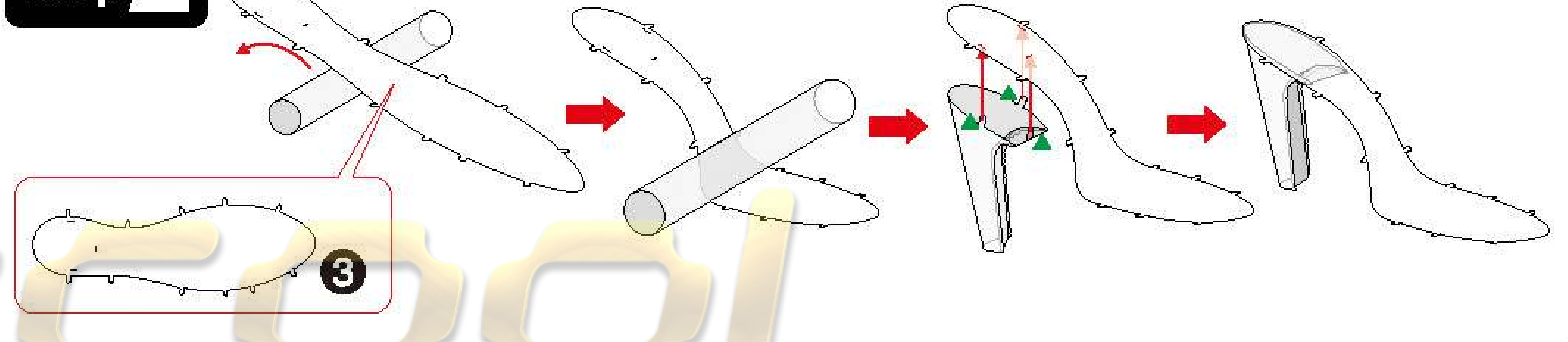

Step 3

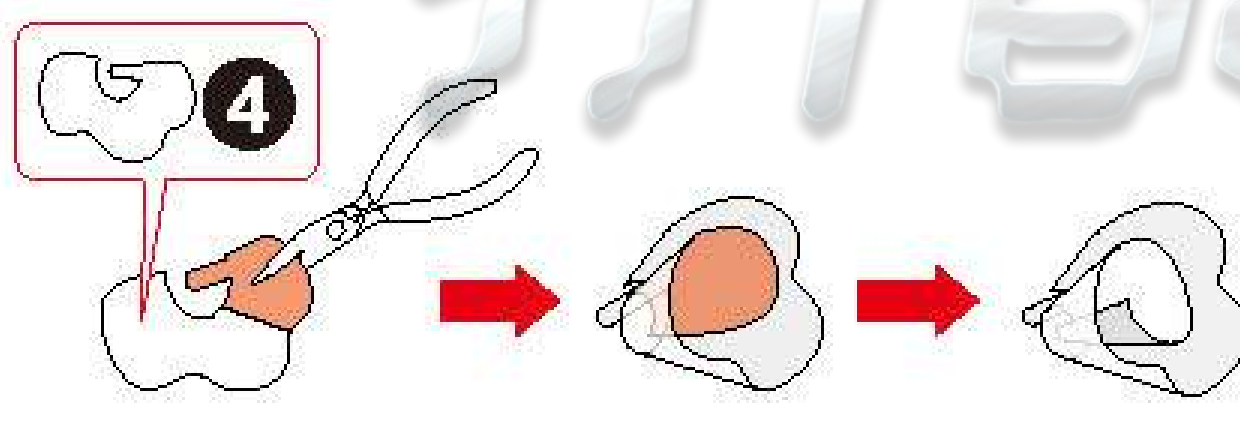

Step 4

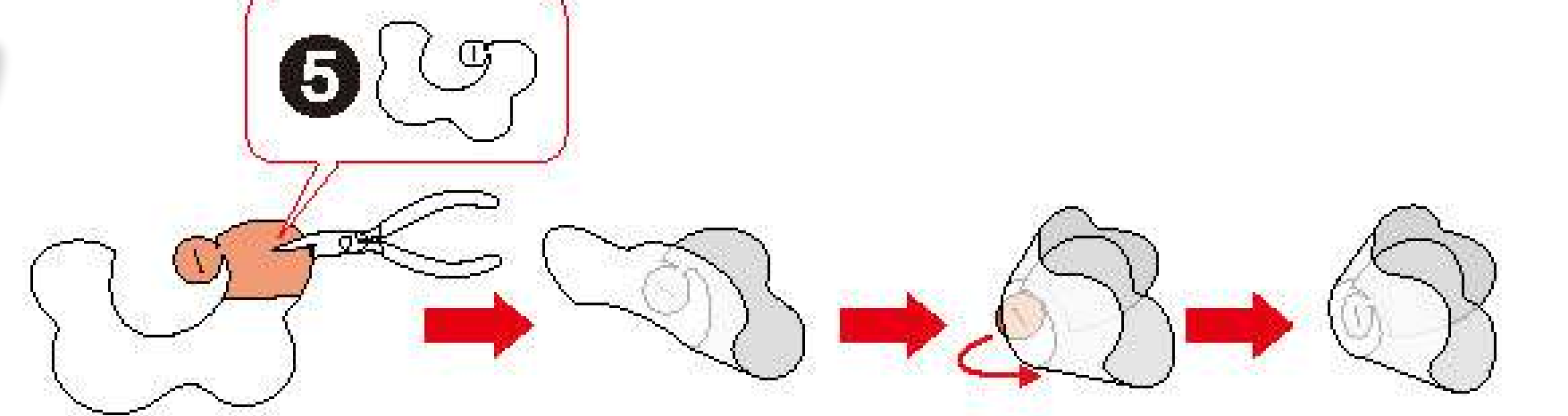

Step 5

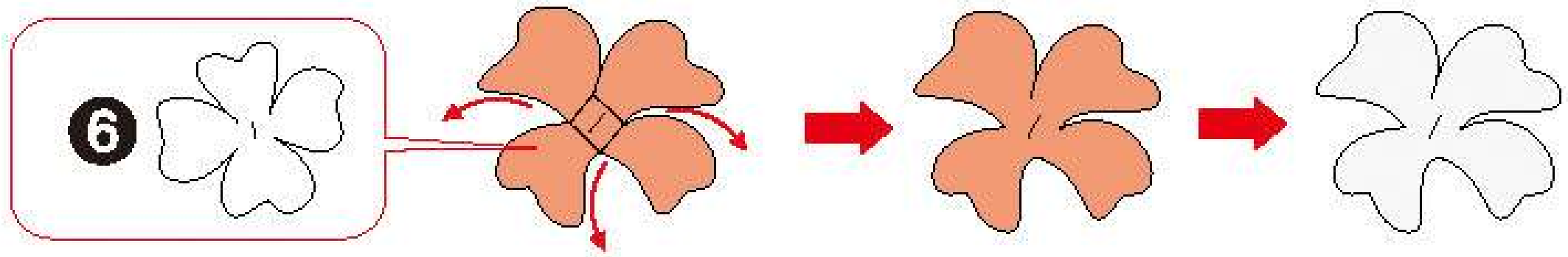

Step 6

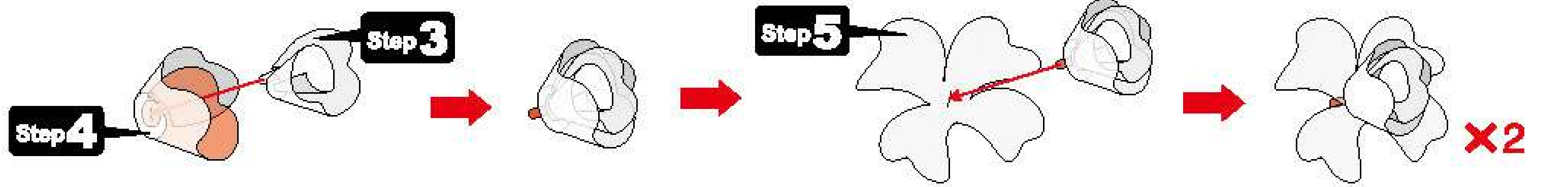

Step 7

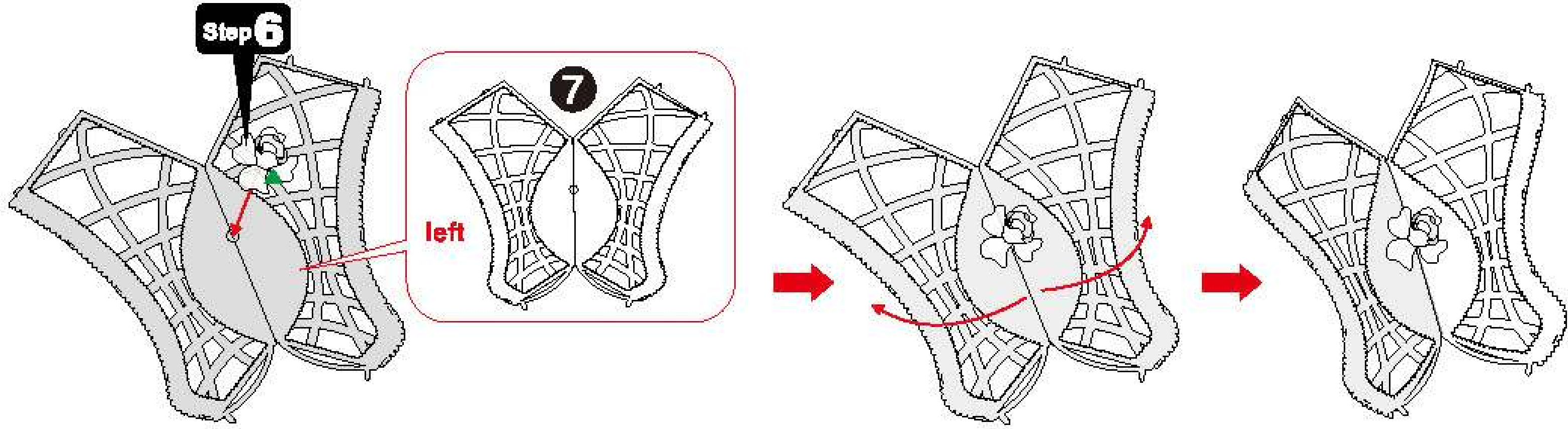

Step 11

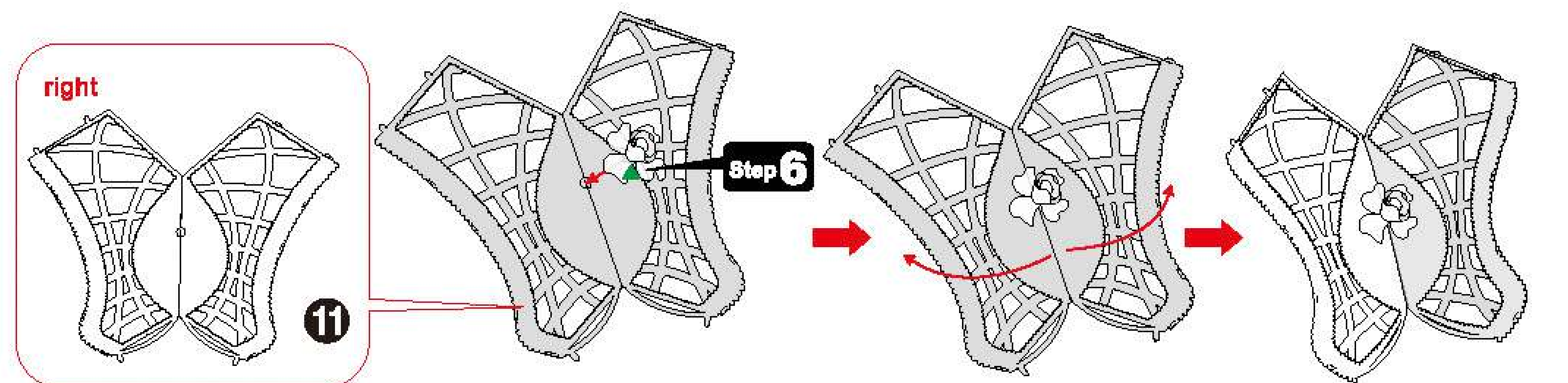

Step 8

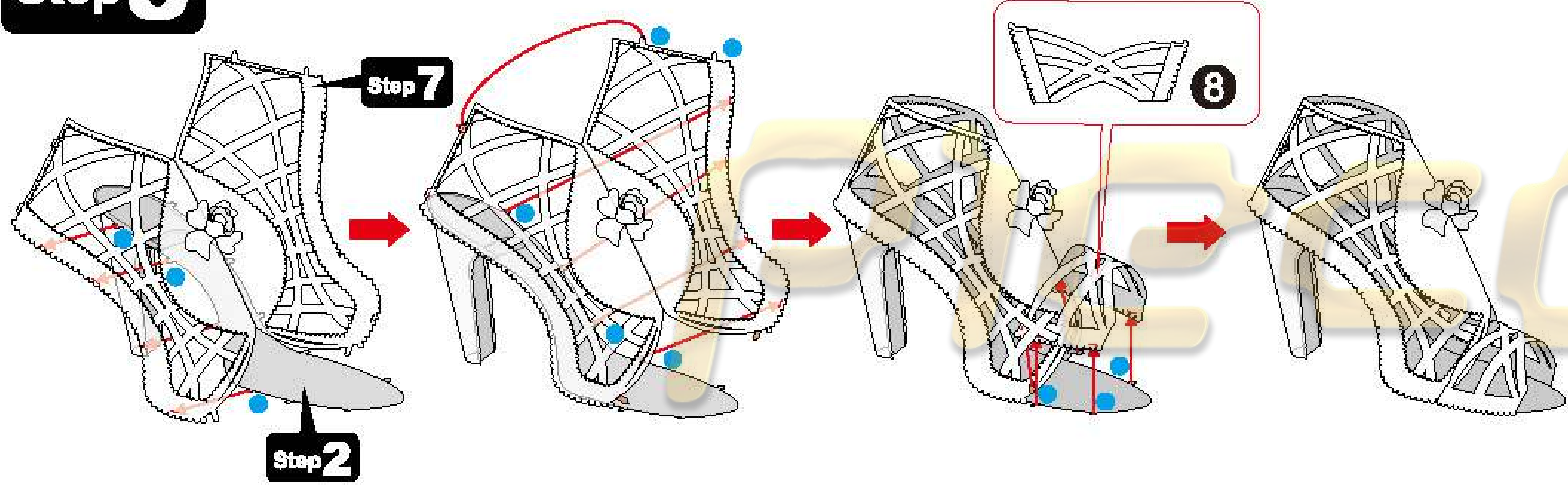

Step 12

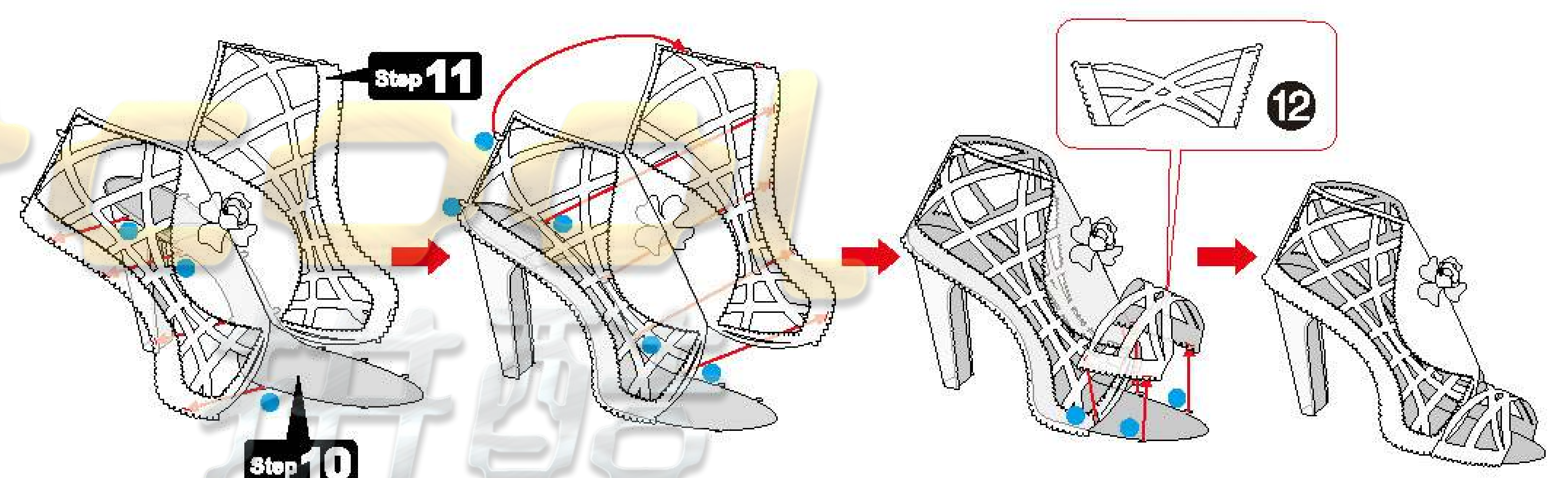

Step 9

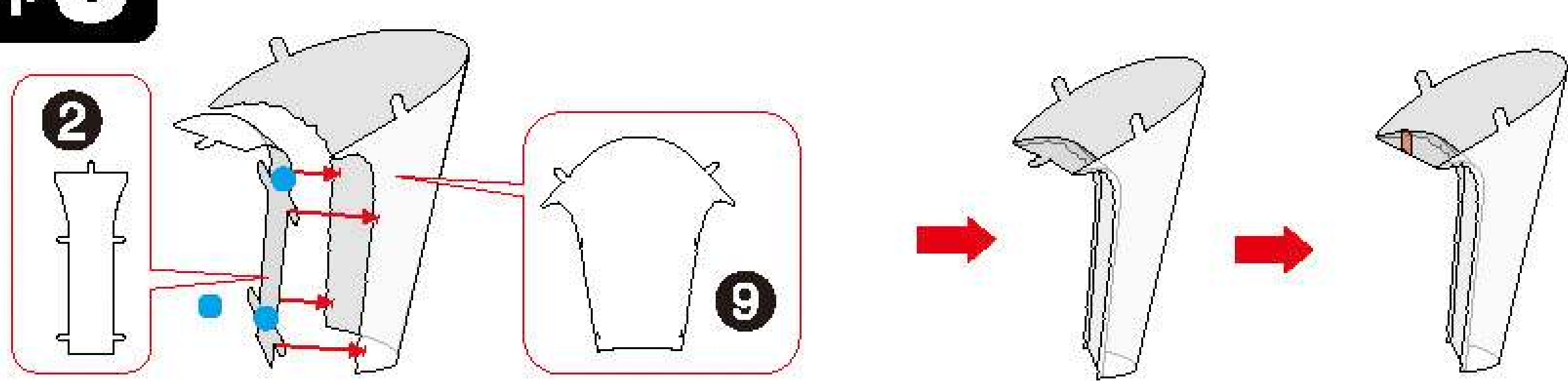

Step 13



Step 10

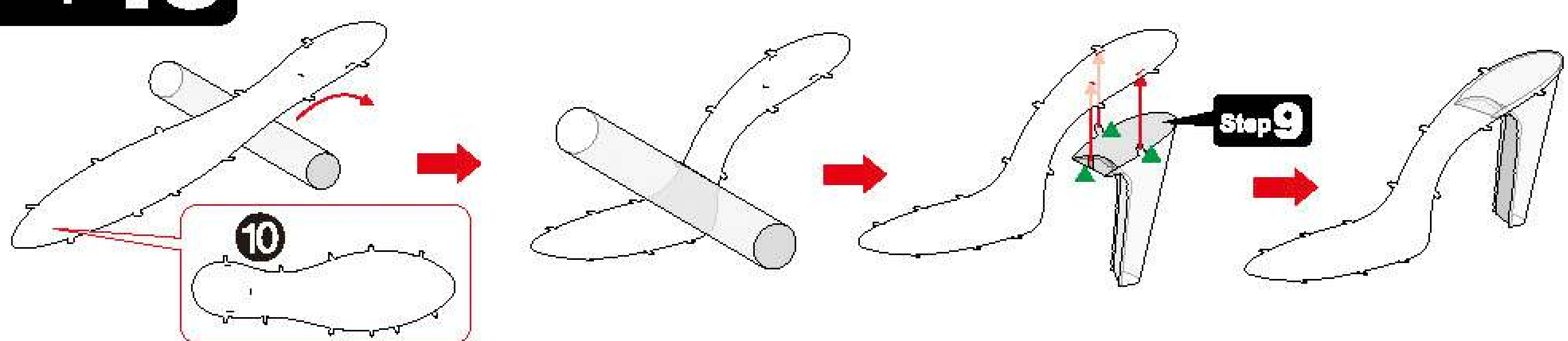

Piececool
拼酷

www.Piececool.com

© WIST PLASTIC & METAL TECHNOLOGY LIMITED. ALL RIGHTS RESERVED.