



美国国会 US CAPITOL P015-G/S

拼装说明书

拼装提示 TIPS:

本产品采用扣点与扣位卡扣拼折的拼装方式，未发生拼装损坏，无需使用胶水 

建议购买并使用拼酷正品拼装工具， T-SKQ05 水口钳  ， T-JZQ05 尖嘴钳  ， 拼装更省时省力，作品更精细美观！

请参照包装内说明书进行拼装，请勿反复拼折金属零件，以免损坏。

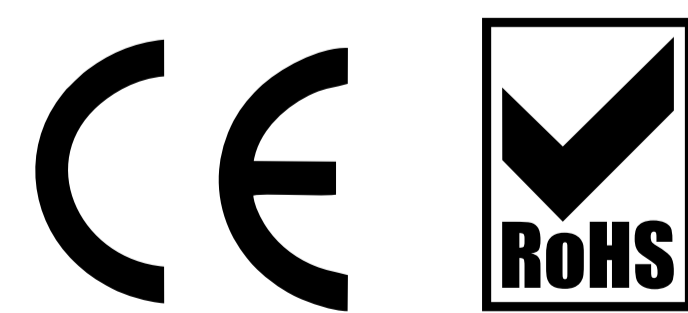

AGES 14+

本产品为金属制品，14岁以下需由成人陪同完成！

15

piececool
拼酷

美国国会

US CAPITOL

挑战星级 Difficulty Level



P015-G

DIY拼装，动手动脑，乐趣多多，
品类多样，寓意丰富，
收藏、送礼两相宜！

DIY 手工艺艺术

ORIGINAL
DESIGN
原创设计

METAL
CRAFT 金属工艺

ASSEMBLY
MODEL 拼装模型

HOME
ARTWORK
家居陈列饰品

FUNNY
GIFTS
创意礼品



建筑
类别

拼酷金属拼装模型，炫酷的金属材质，精密的空间结构，
意想不到的四维酷爽大挑战，让您享受玩家级的拼装与收藏体验！

美国国会 US CAPITOL

piececool 拼酷

15

piececool
拼酷

美国国会

US CAPITOL

挑战星级 Difficulty Level



P015-S

DIY拼装，动手动脑，乐趣多多，
品类多样，寓意丰富，
收藏、送礼两相宜！

DIY 手工艺艺术

ORIGINAL
DESIGN
原创设计

METAL
CRAFT 金属工艺

ASSEMBLY
MODEL 拼装模型

HOME
ARTWORK
家居陈列饰品

FUNNY
GIFTS
创意礼品



建筑
类别

拼酷金属拼装模型，炫酷的金属材质，精密的空间结构，
意想不到的四维酷爽大挑战，让您享受玩家级的拼装与收藏体验！

美国国会 US CAPITOL

piececool 拼酷

组装基本步骤示意图

● 插入扣孔，平折 90°

▲ 插入扣孔，旋转 90°

折线

扣点

扣孔

拼装工具

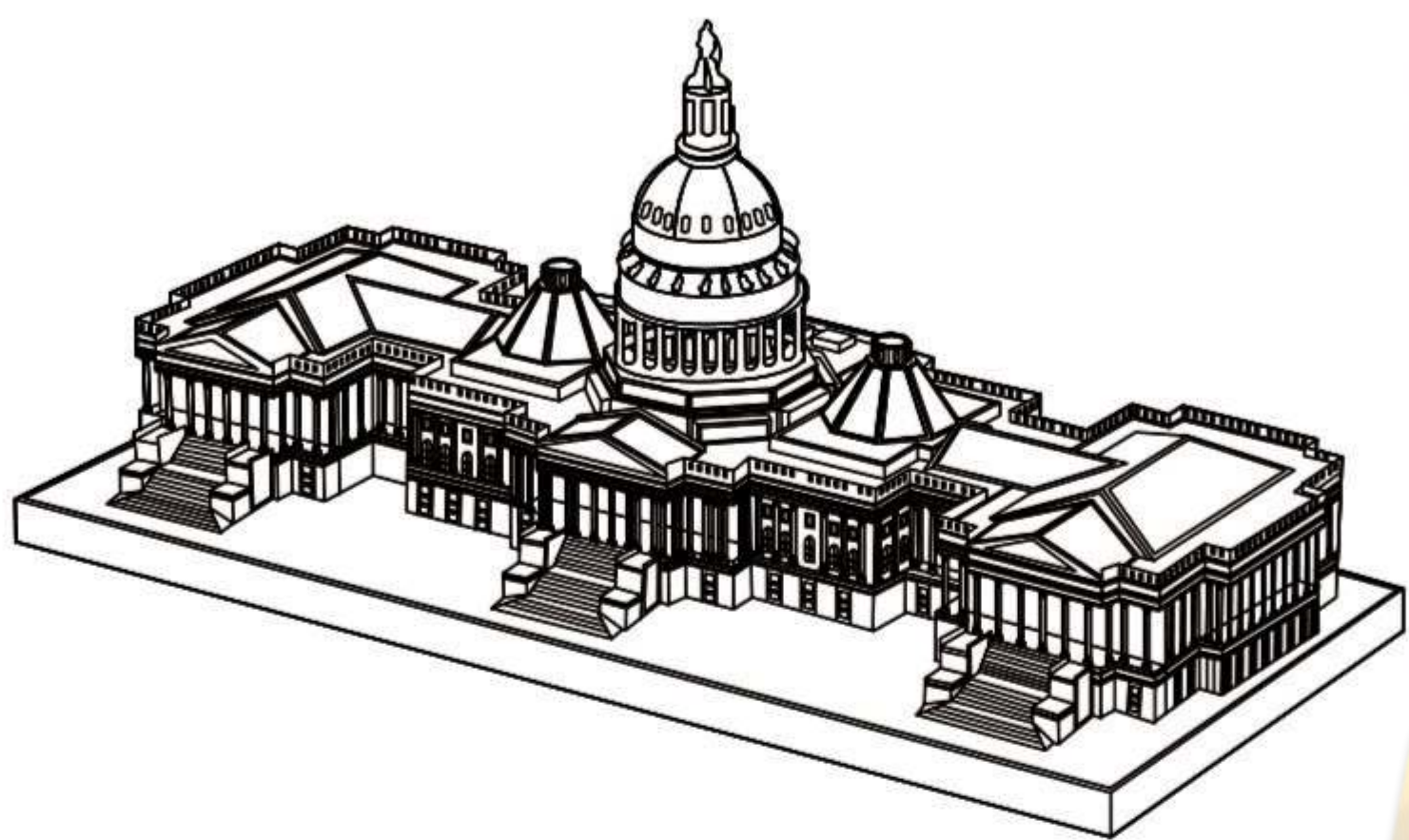

金属部件

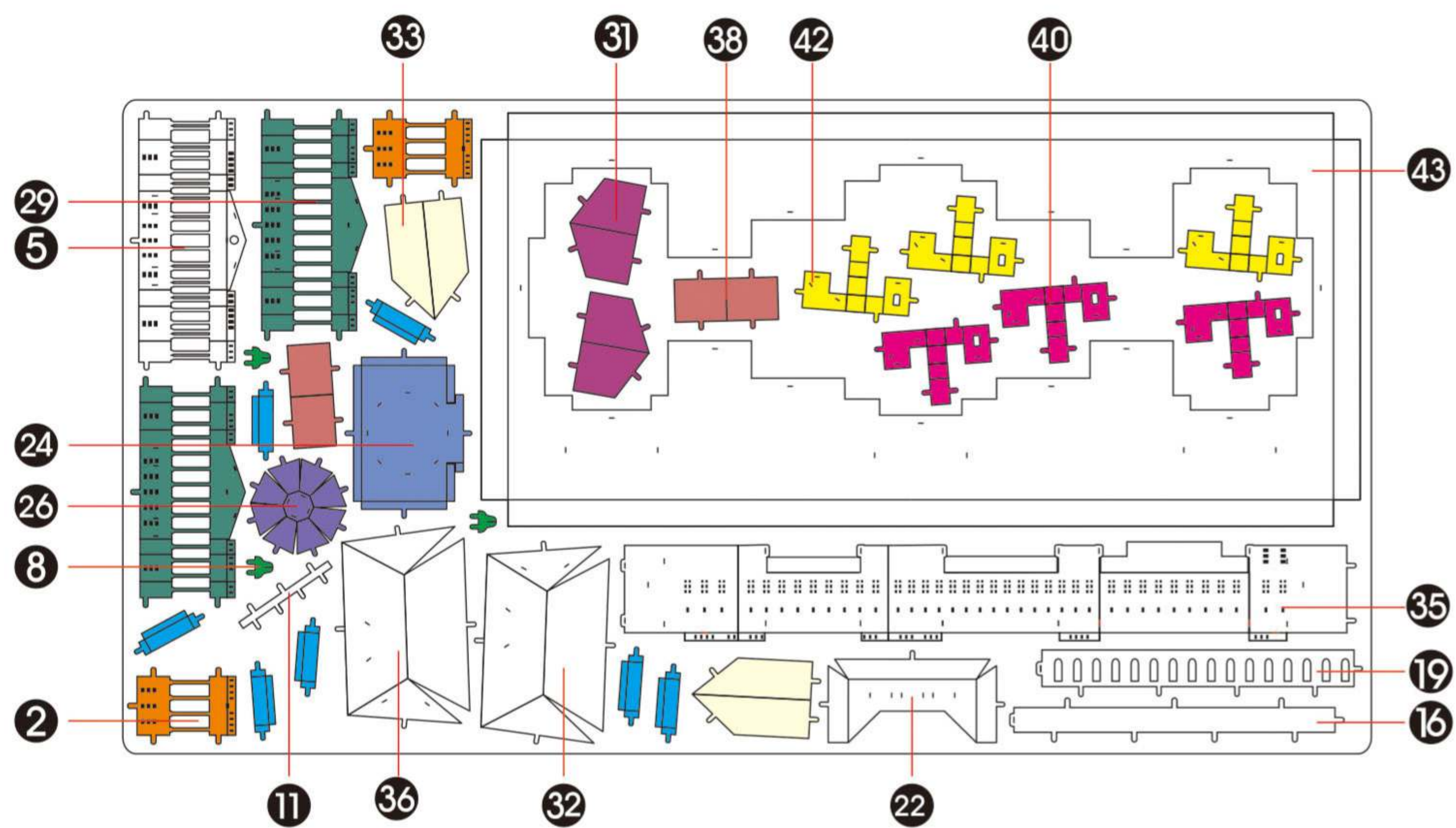

⚠ 请小心处理金属边料，以防划伤

拼装步骤

Step 1

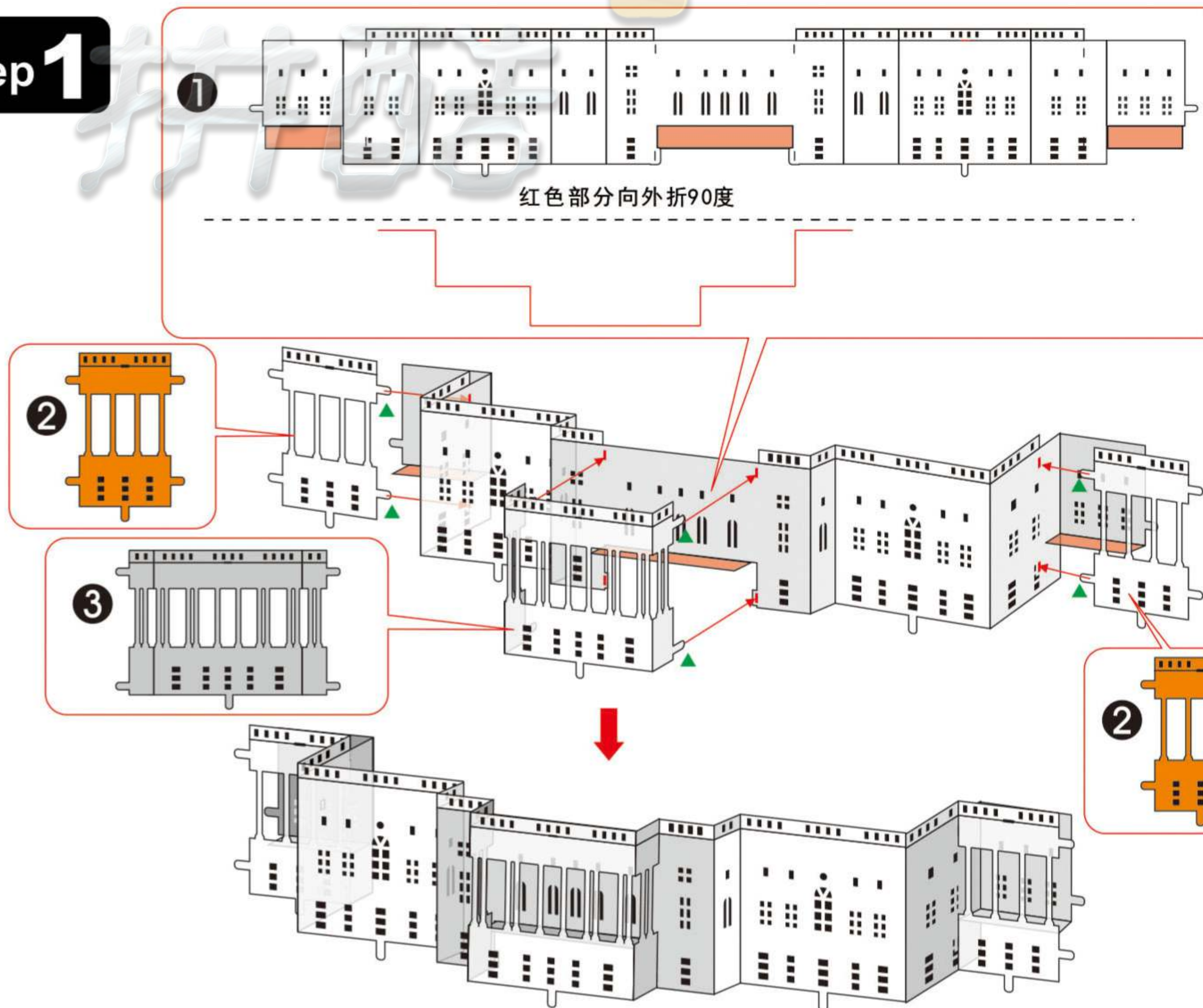

Step 2

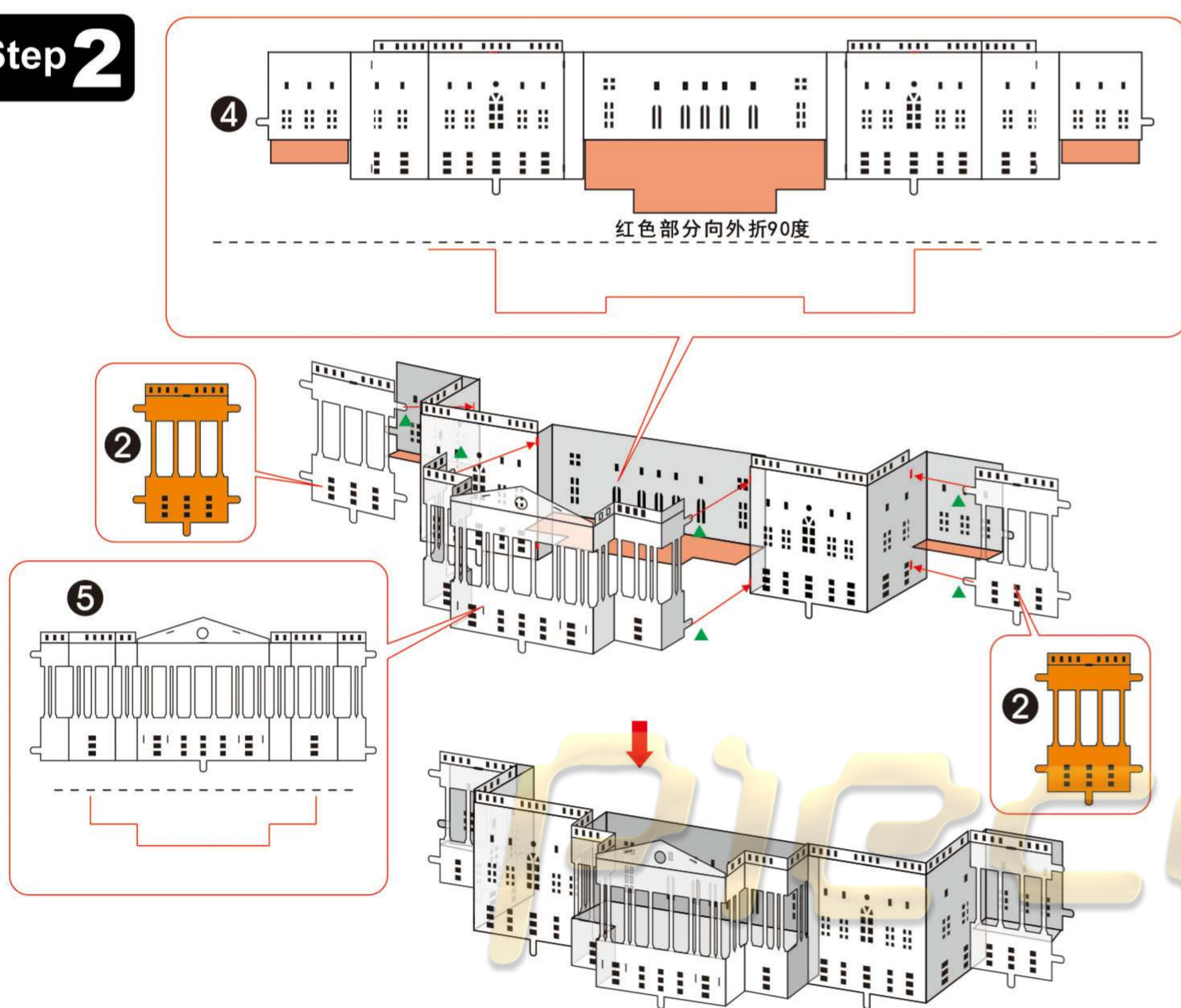

Step 4

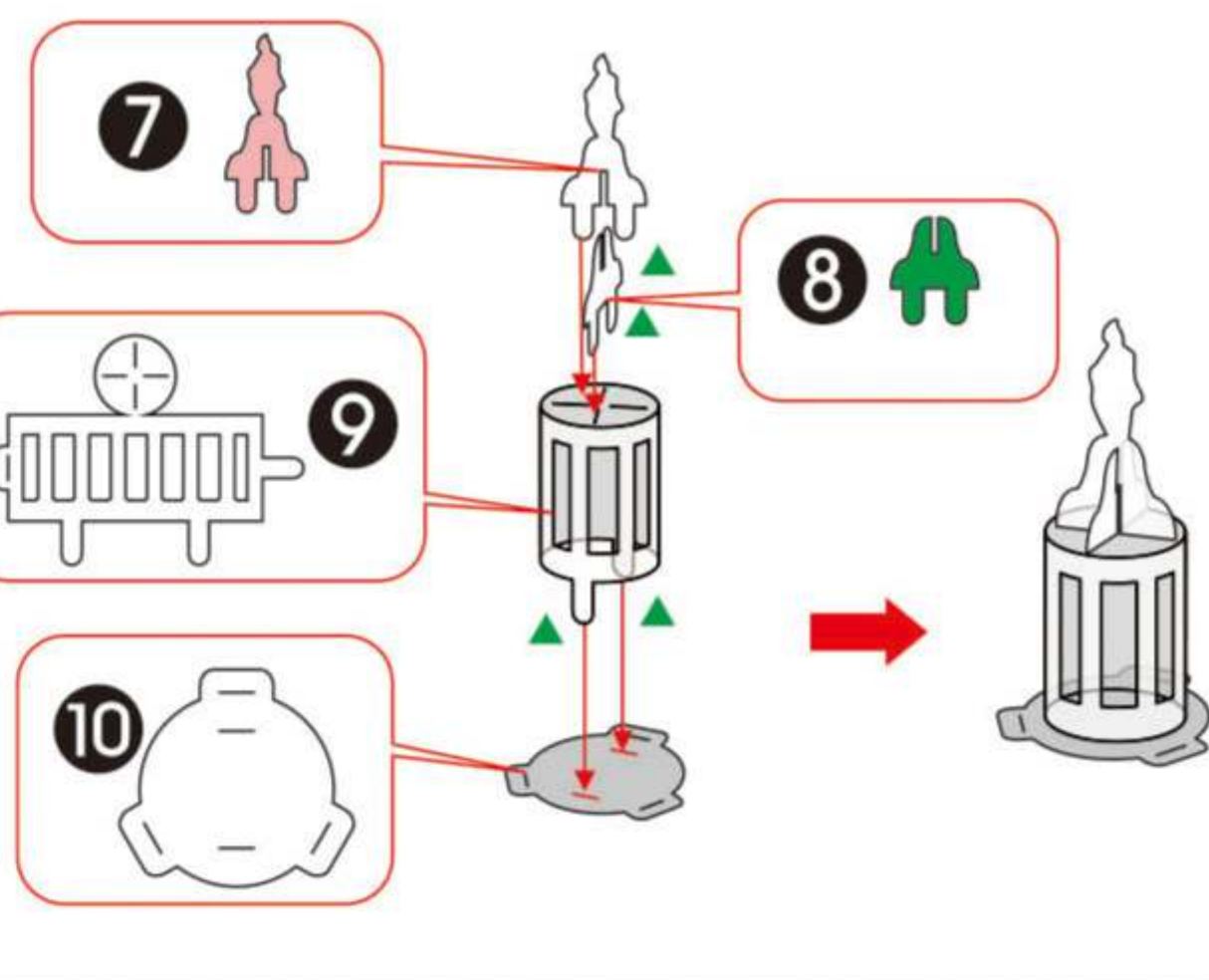

Step 5

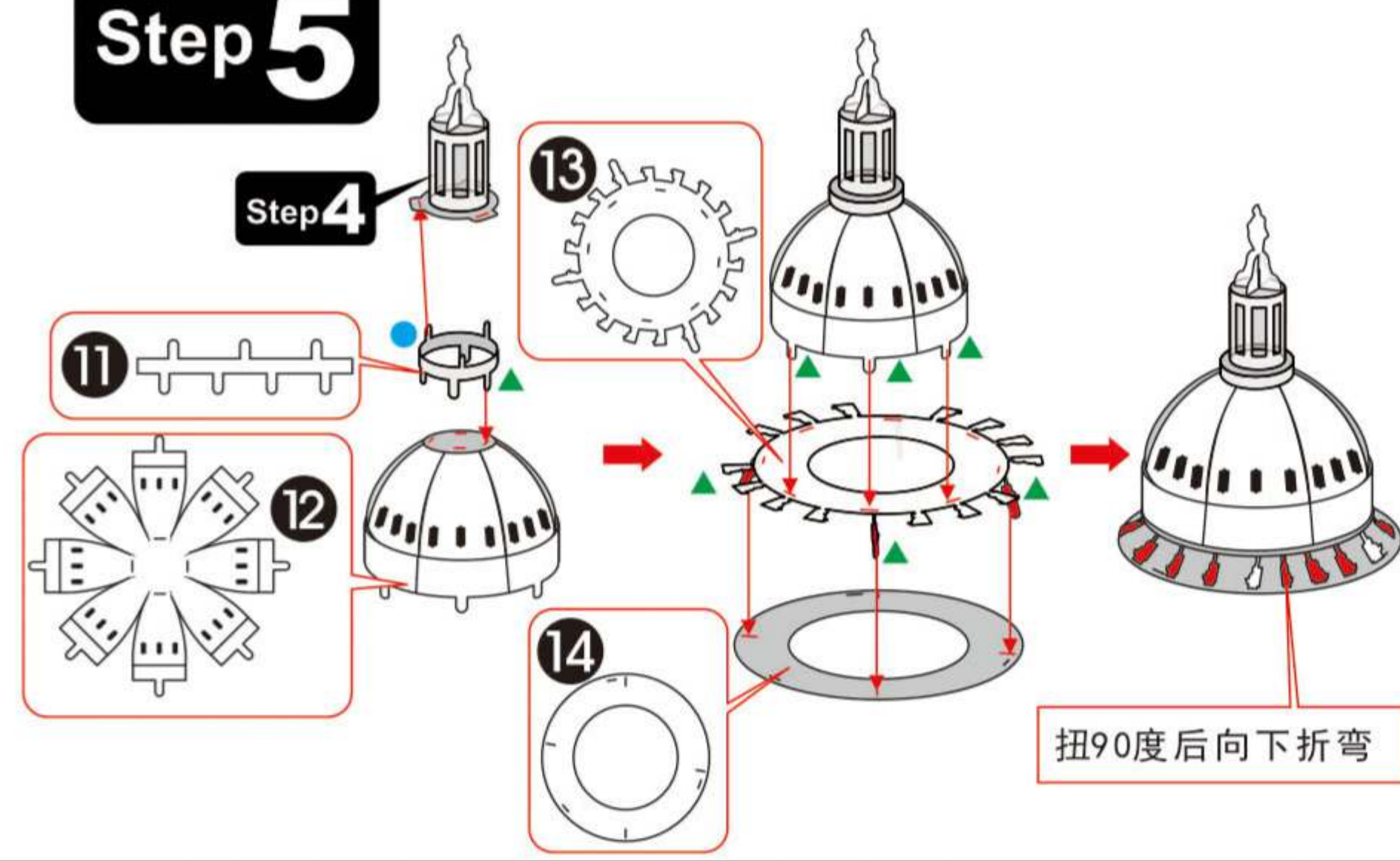

Step 6

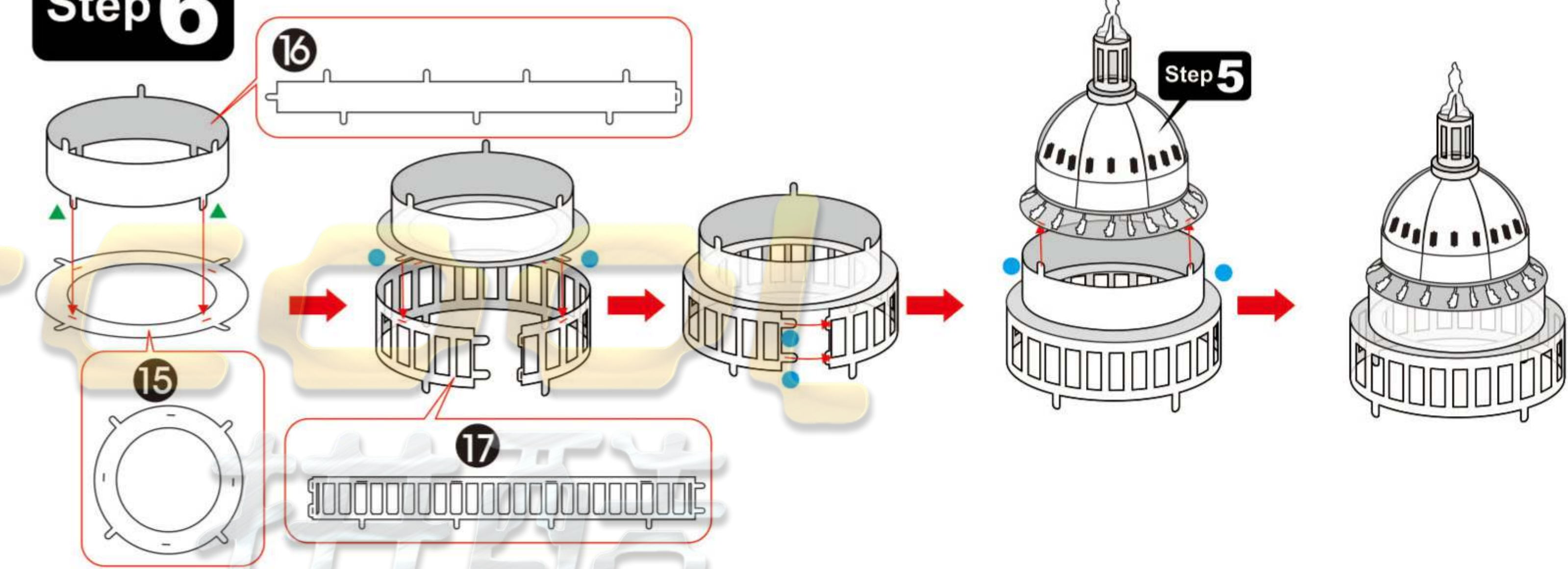

Step 3

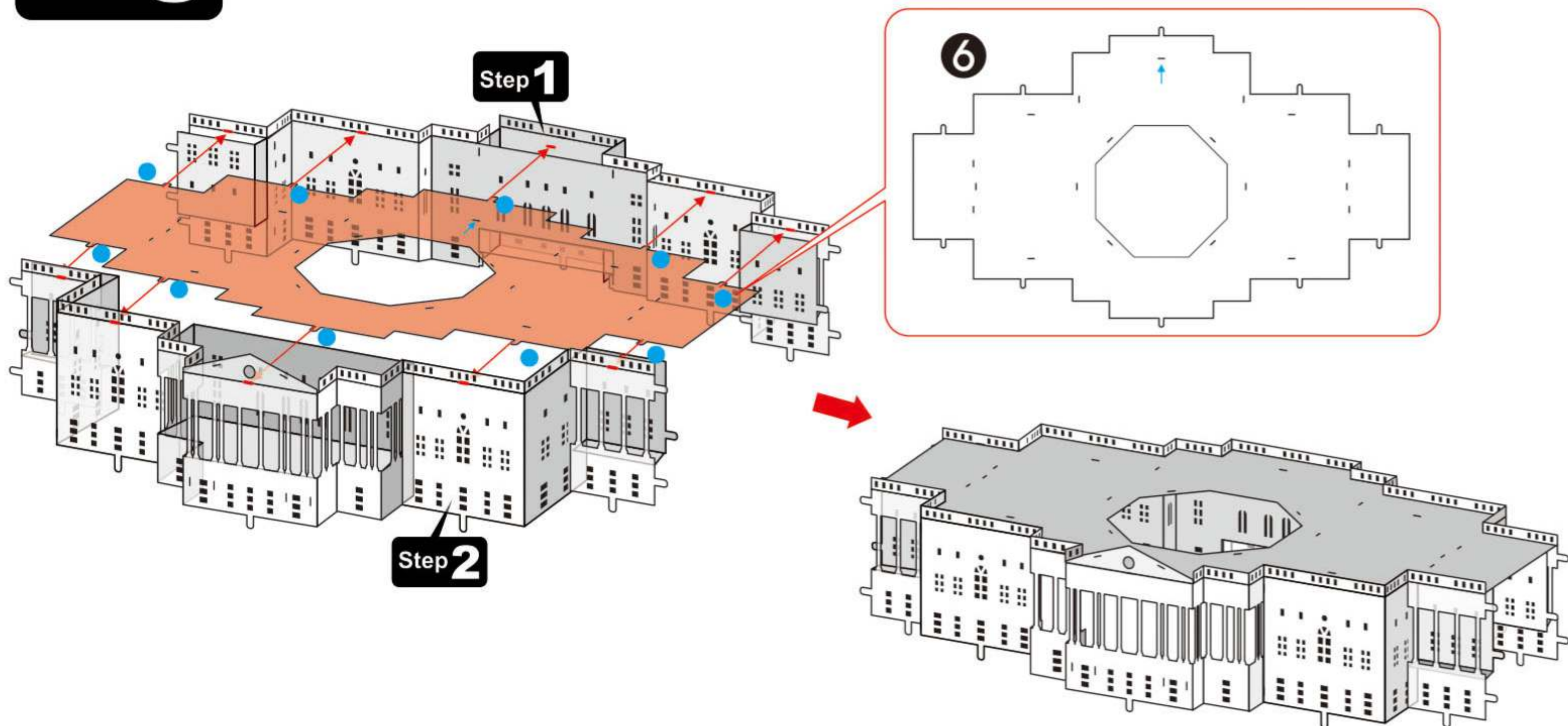

Step 7

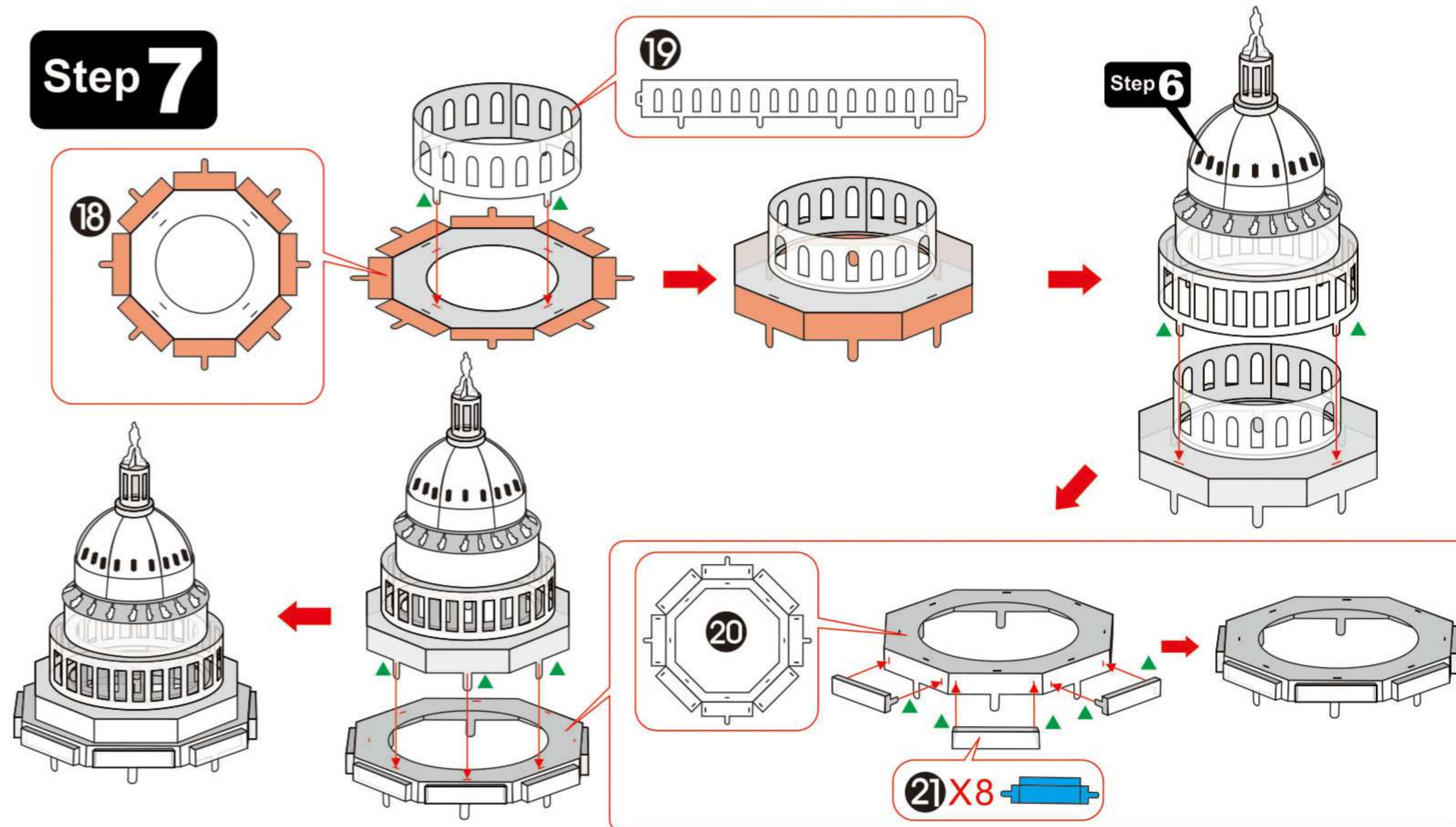

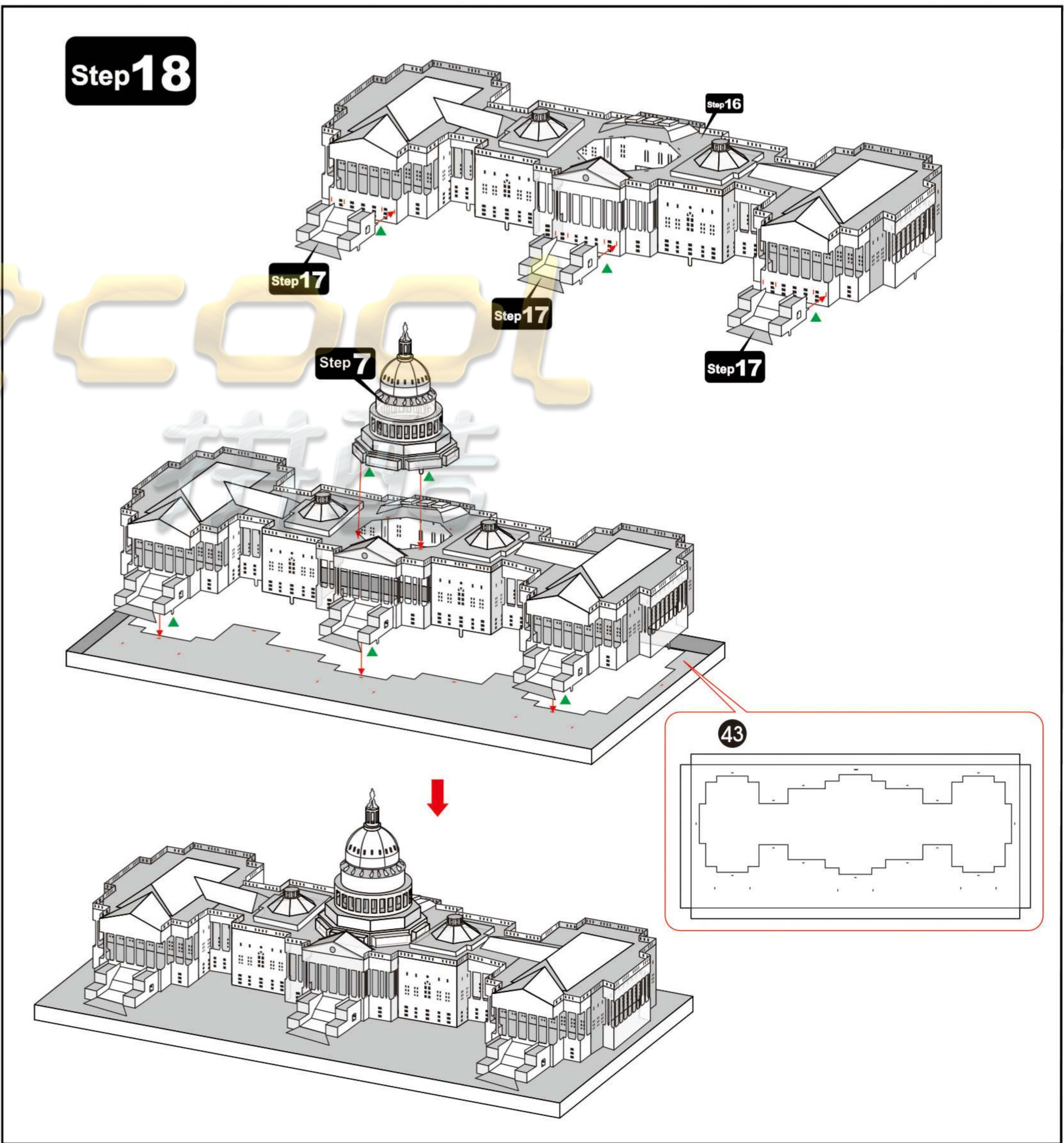
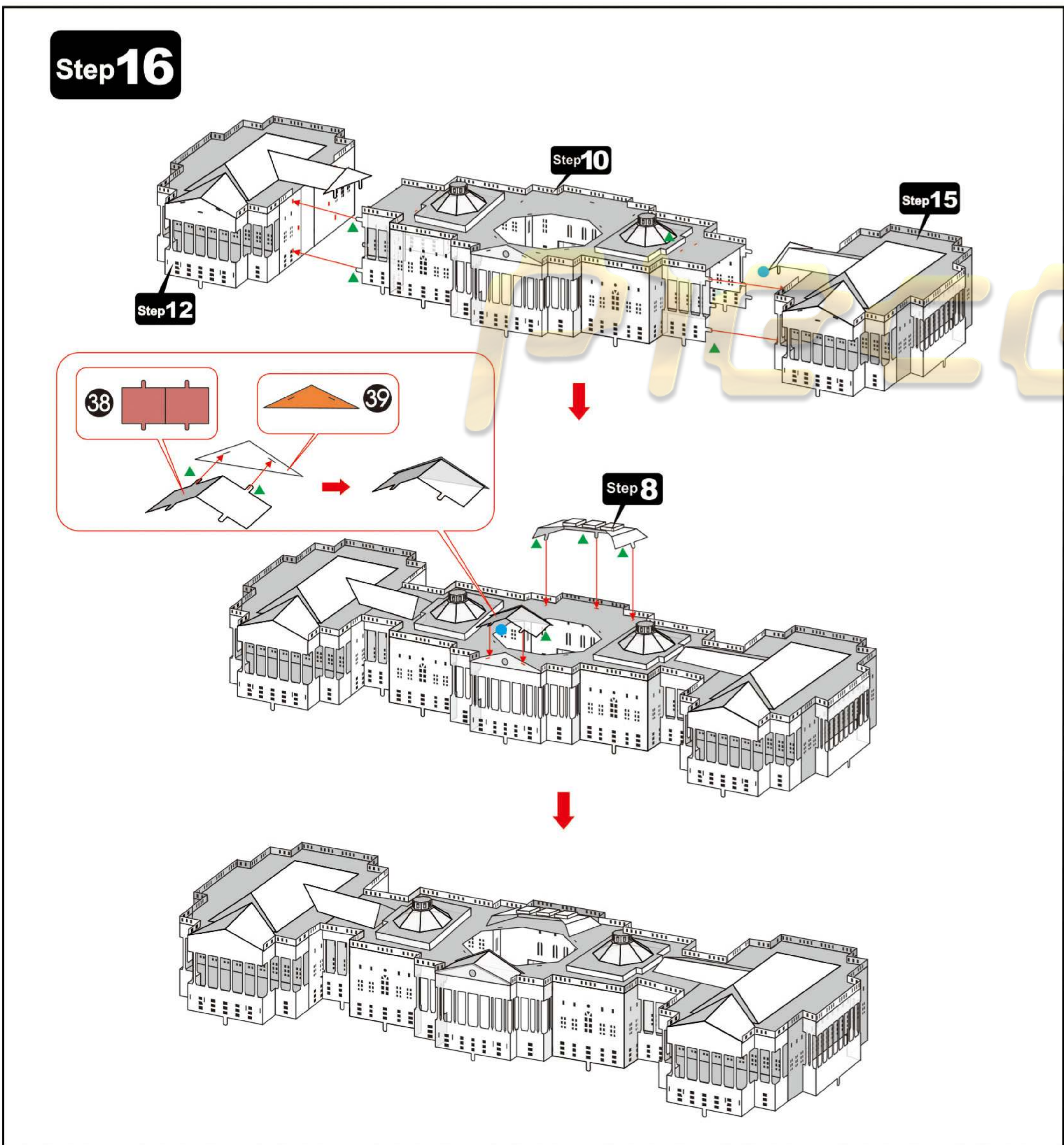
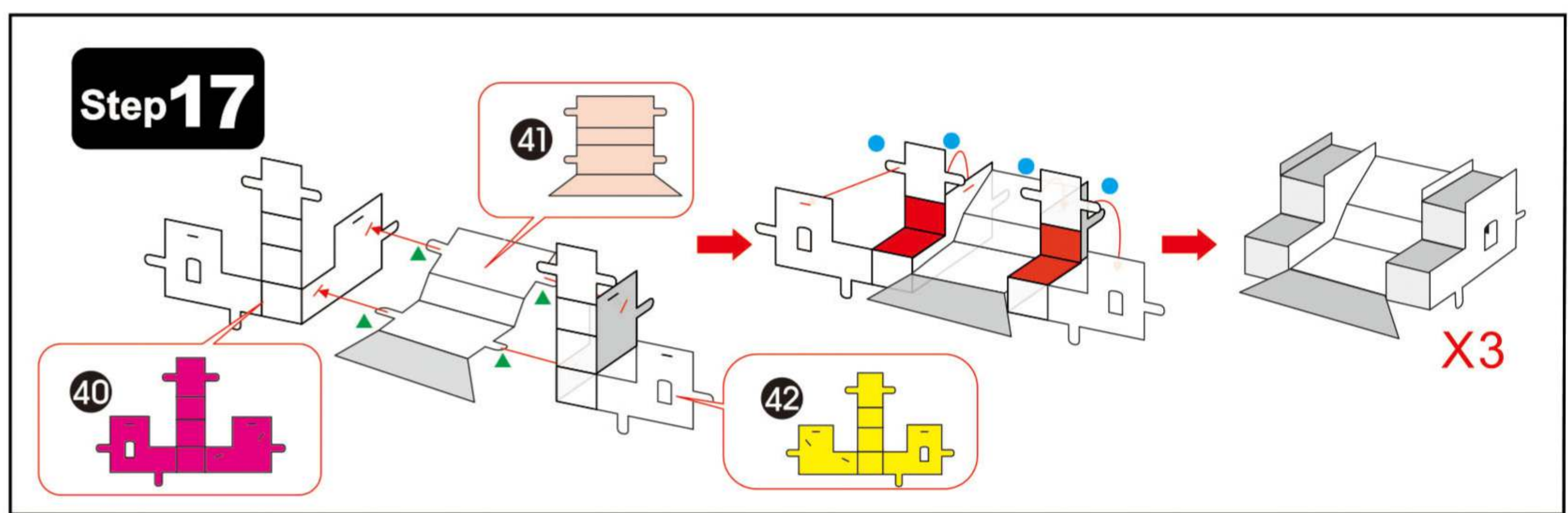
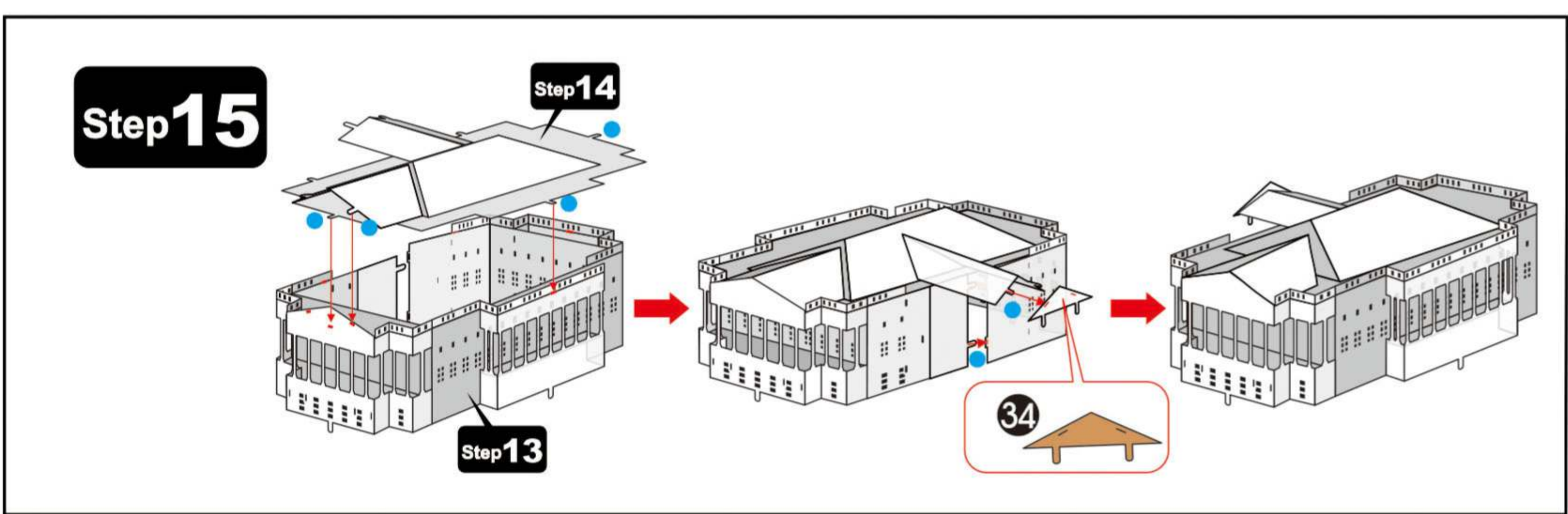
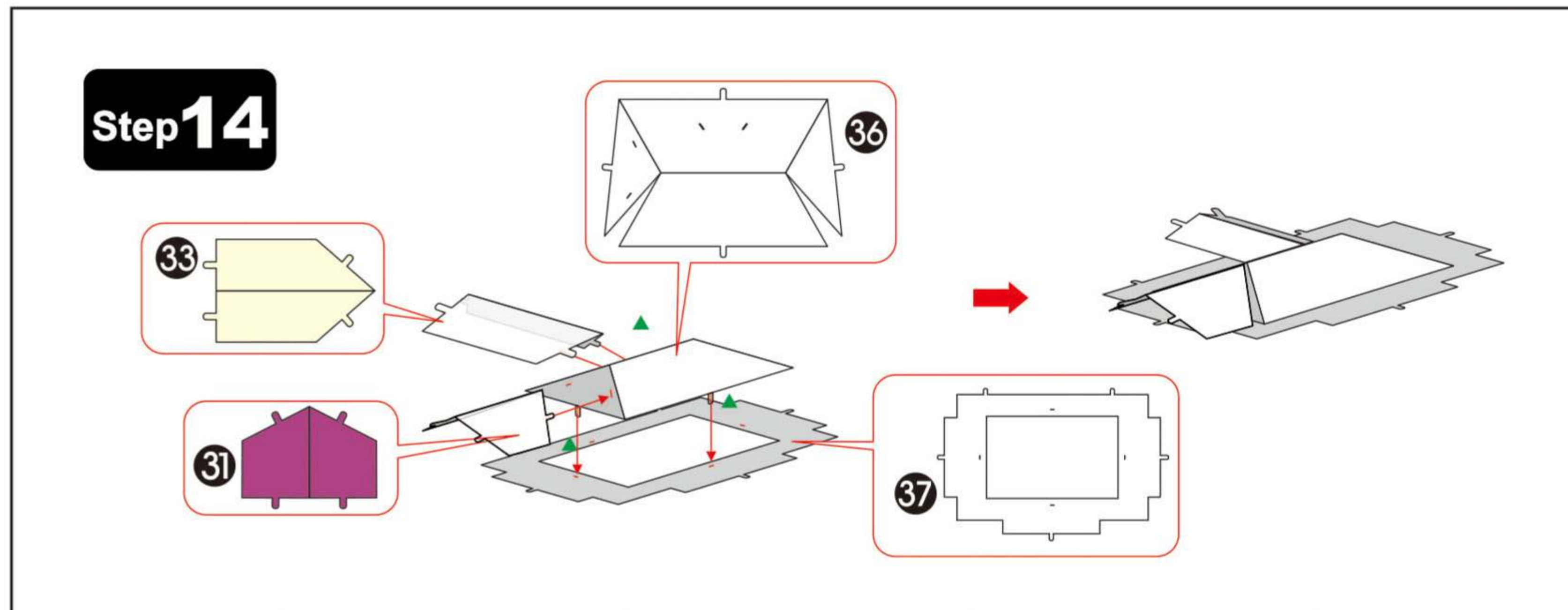
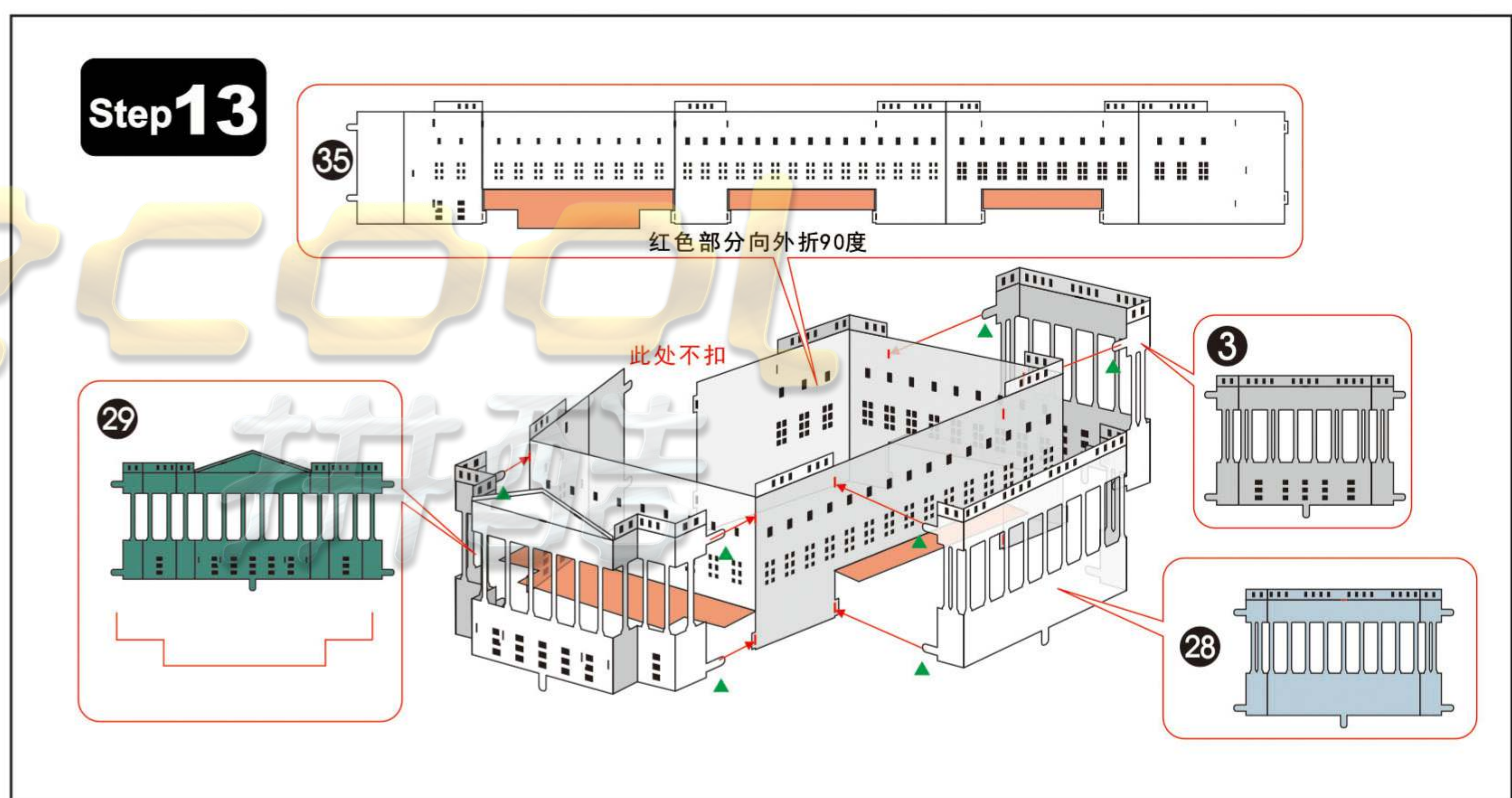
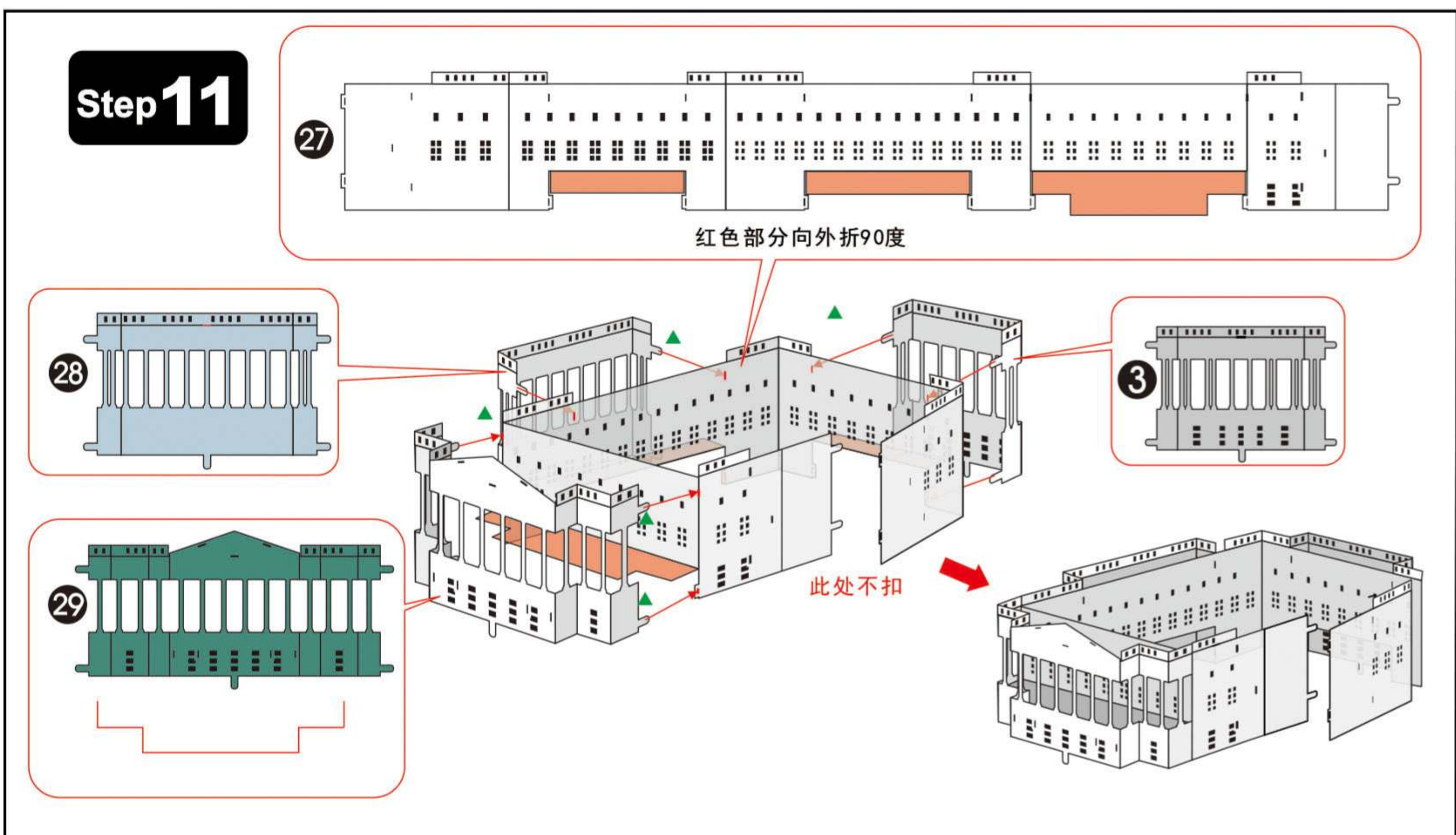
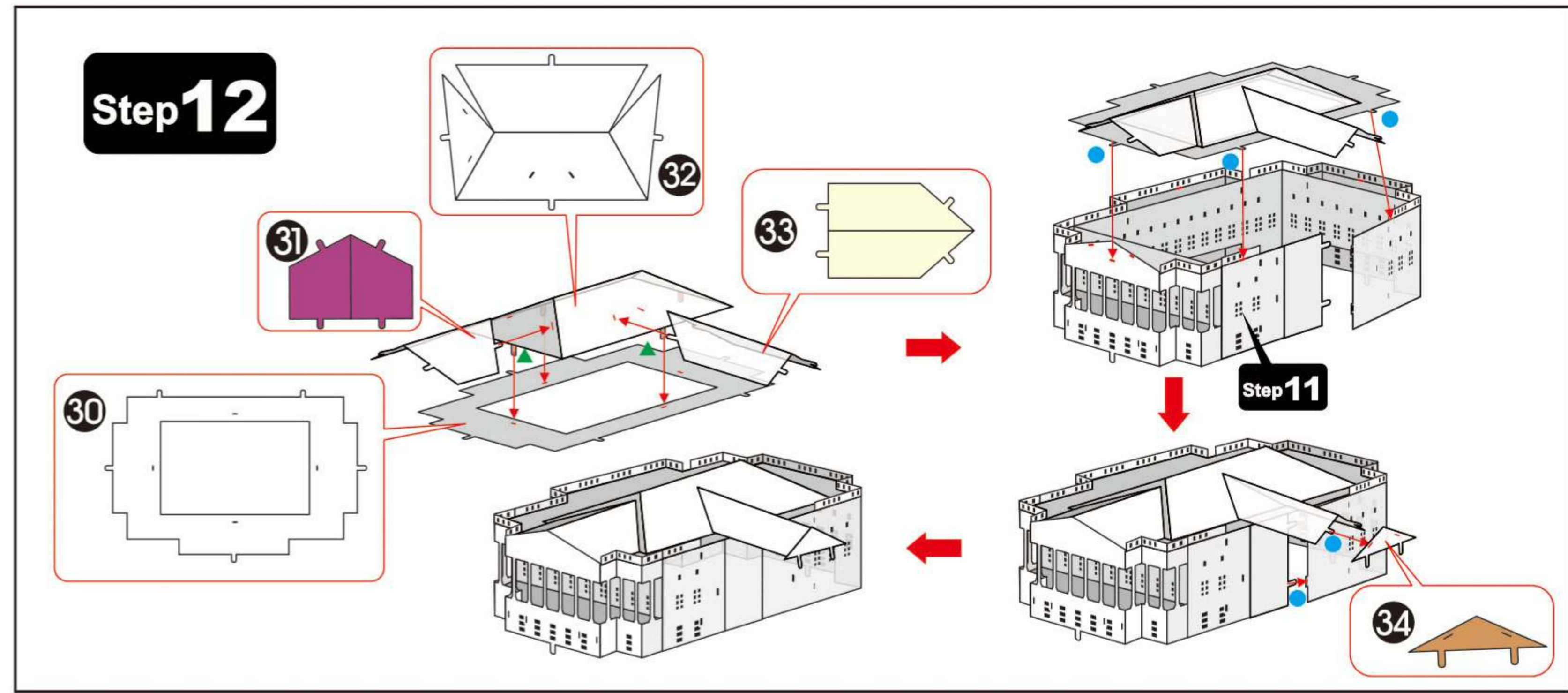
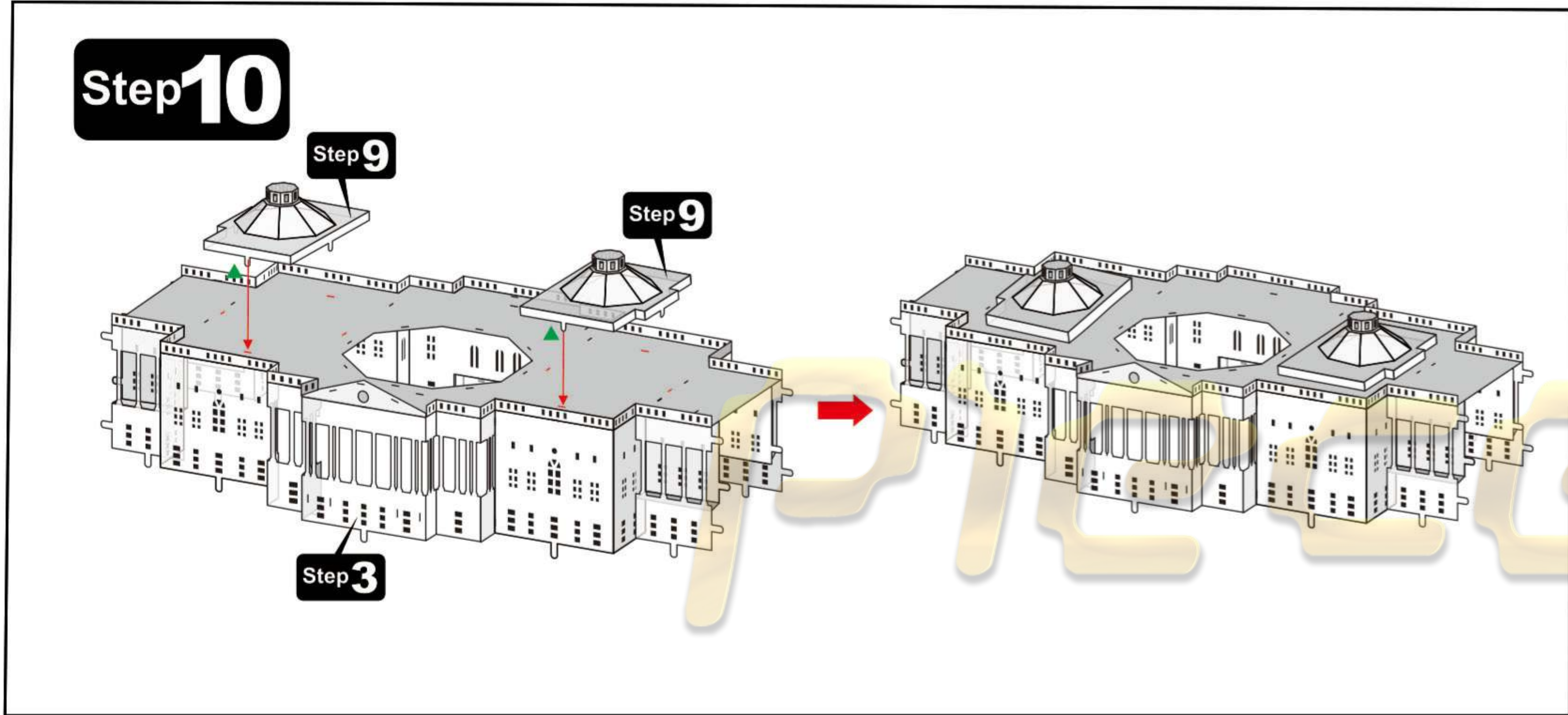
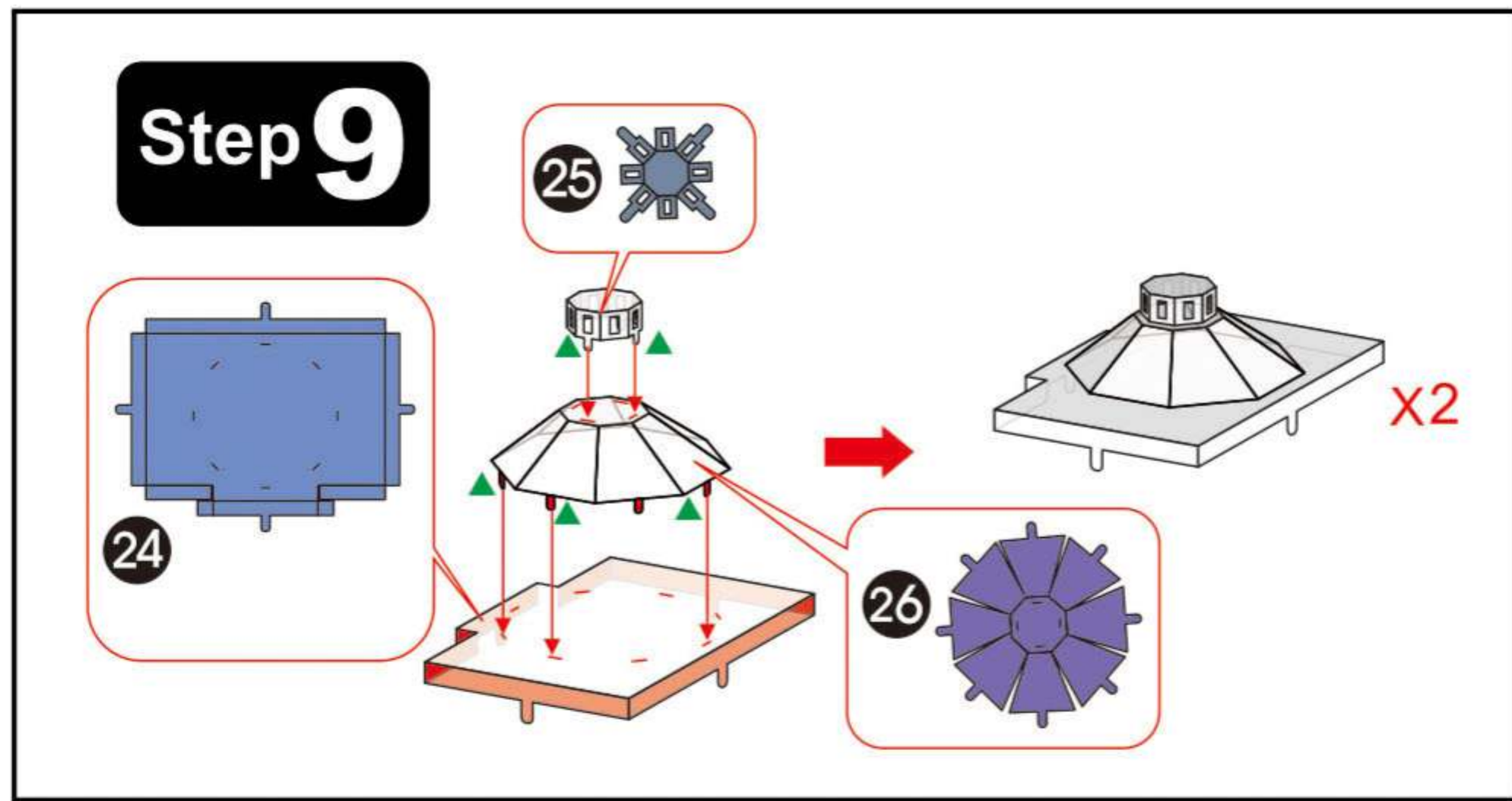
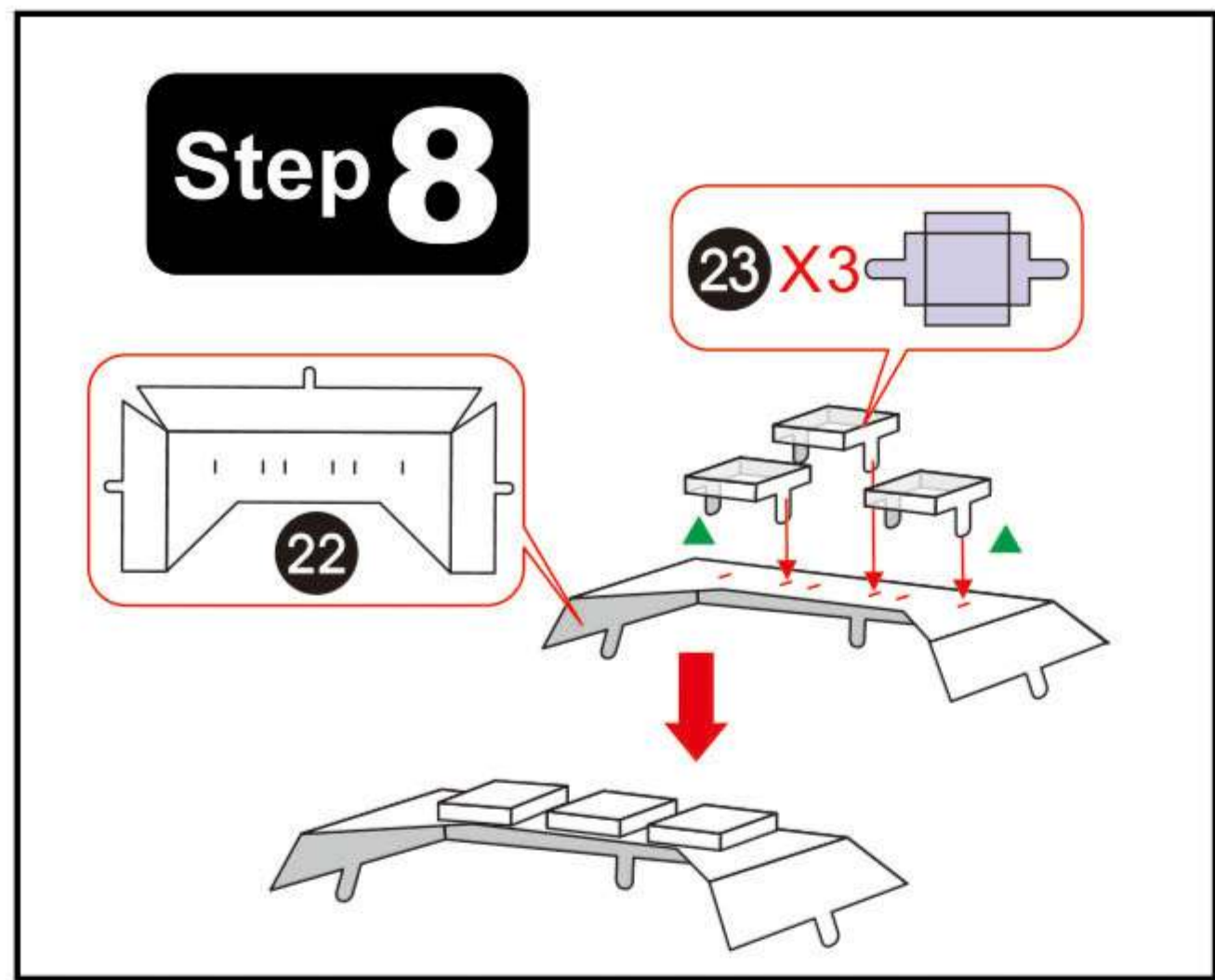

Piececool
拼酷

www.Piececool.com

© WIST PLASTIC & METAL TECHNOLOGY LIMITED. ALL RIGHTS RESERVED.