



白宫
THE WHITE HOUSE
P010-G/S

拼装说明书

拼装提示 TIPS:

本产品采用扣点与扣位卡扣拼折的拼装方式，未发生拼装损坏，无需使用胶水 

建议购买并使用拼酷正品拼装工具， T-SKQ05 水口钳  ， T-JZQ05 尖嘴钳  ， 拼装更省时省力，作品更精细美观！

请参照包装内说明书进行拼装，请勿反复拼折金属零件，以免损坏。

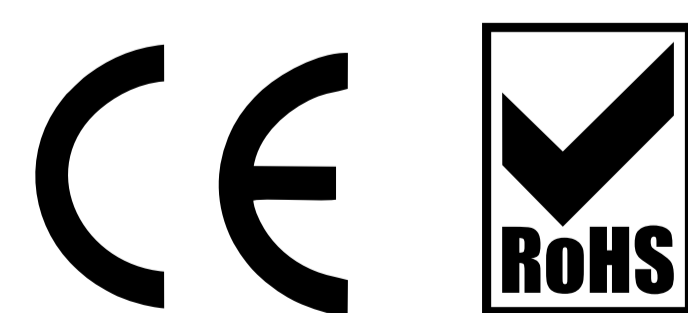

AGES 14+

本产品为金属制品，14岁以下需由成人陪同完成！

10

piececool
拼酷

白宫

THE WHITE HOUSE

挑战星级 Difficulty Level



P010-G

DIY拼装, 动手动脑, 乐趣多多,
品类多样, 寓意丰富,
收藏、送礼两相宜!

DIY 手工艺艺术

ORIGINAL DESIGN
原创设计

METAL CRAFT 金属工艺

ASSEMBLY MODEL 拼装模型

HOME ARTWORK
家居陈列饰品

FUNNY GIFTS
创意礼品



建筑类别

拼酷金属拼装模型, 炫酷的金属材质, 精密的空间结构,
意想不到的四维酷爽大挑战, 让您享受玩家级的拼装与收藏体验!

THE WHITE HOUSE

piececool
拼酷

10

piececool
拼酷

白宫

THE WHITE HOUSE

挑战星级 Difficulty Level



P010-S

DIY拼装, 动手动脑, 乐趣多多,
品类多样, 寓意丰富,
收藏、送礼两相宜!

DIY 手工艺艺术

ORIGINAL DESIGN
原创设计

METAL CRAFT 金属工艺

ASSEMBLY MODEL 拼装模型

HOME ARTWORK
家居陈列饰品

FUNNY GIFTS
创意礼品



建筑类别

拼酷金属拼装模型, 炫酷的金属材质, 精密的空间结构,
意想不到的四维酷爽大挑战, 让您享受玩家级的拼装与收藏体验!

THE WHITE HOUSE

piececool
拼酷

组装基本步骤示意图

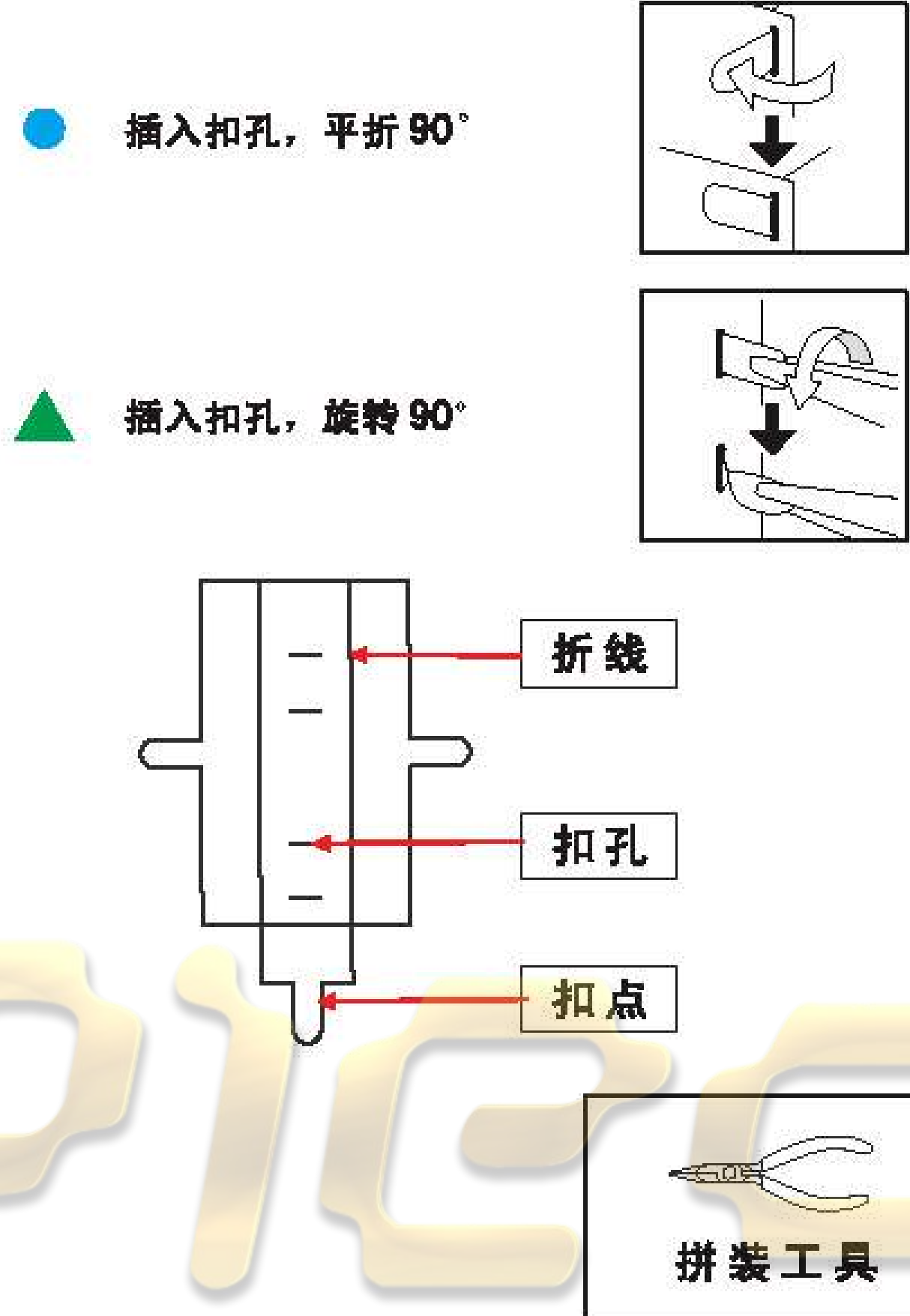
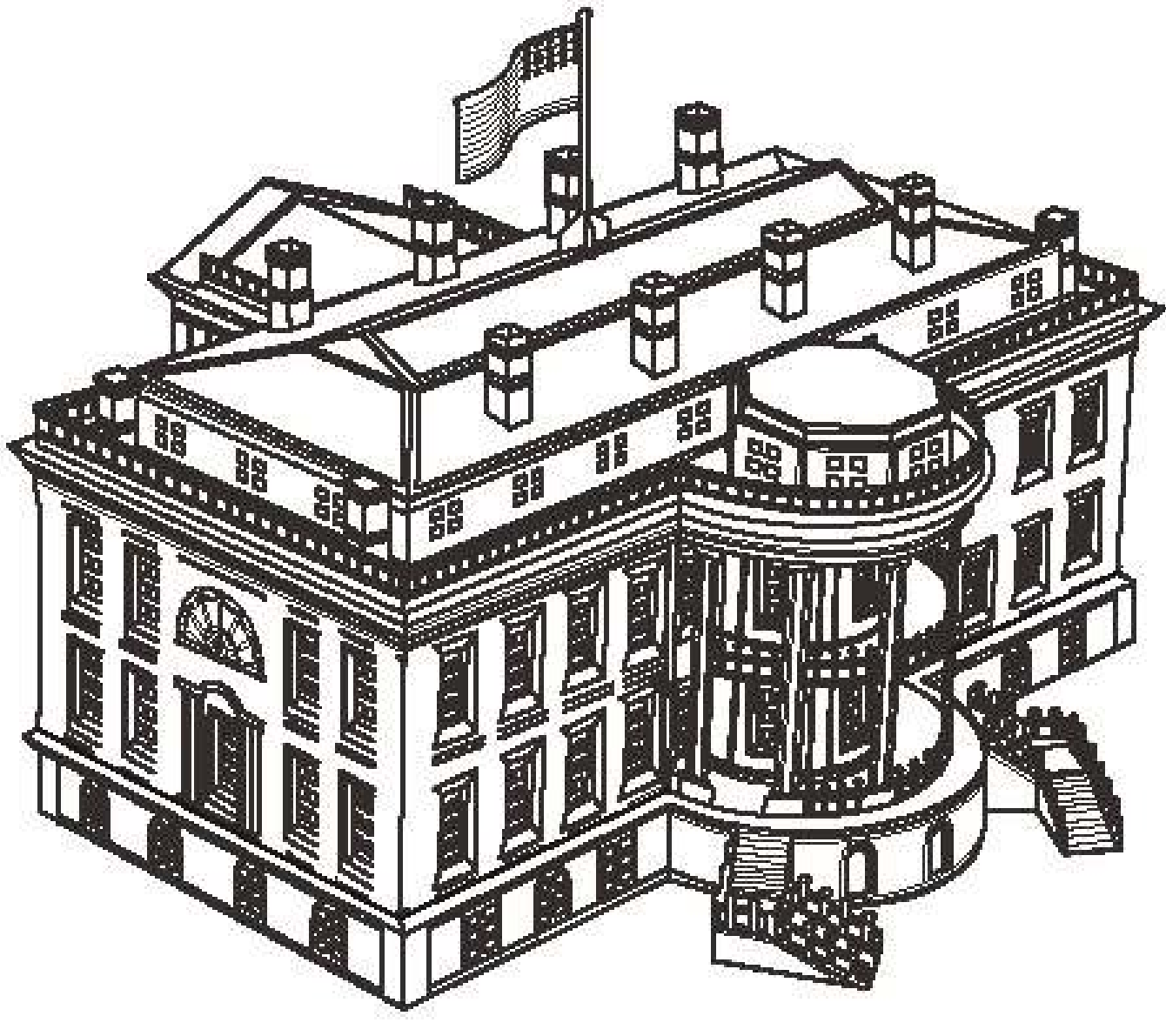

金属部件

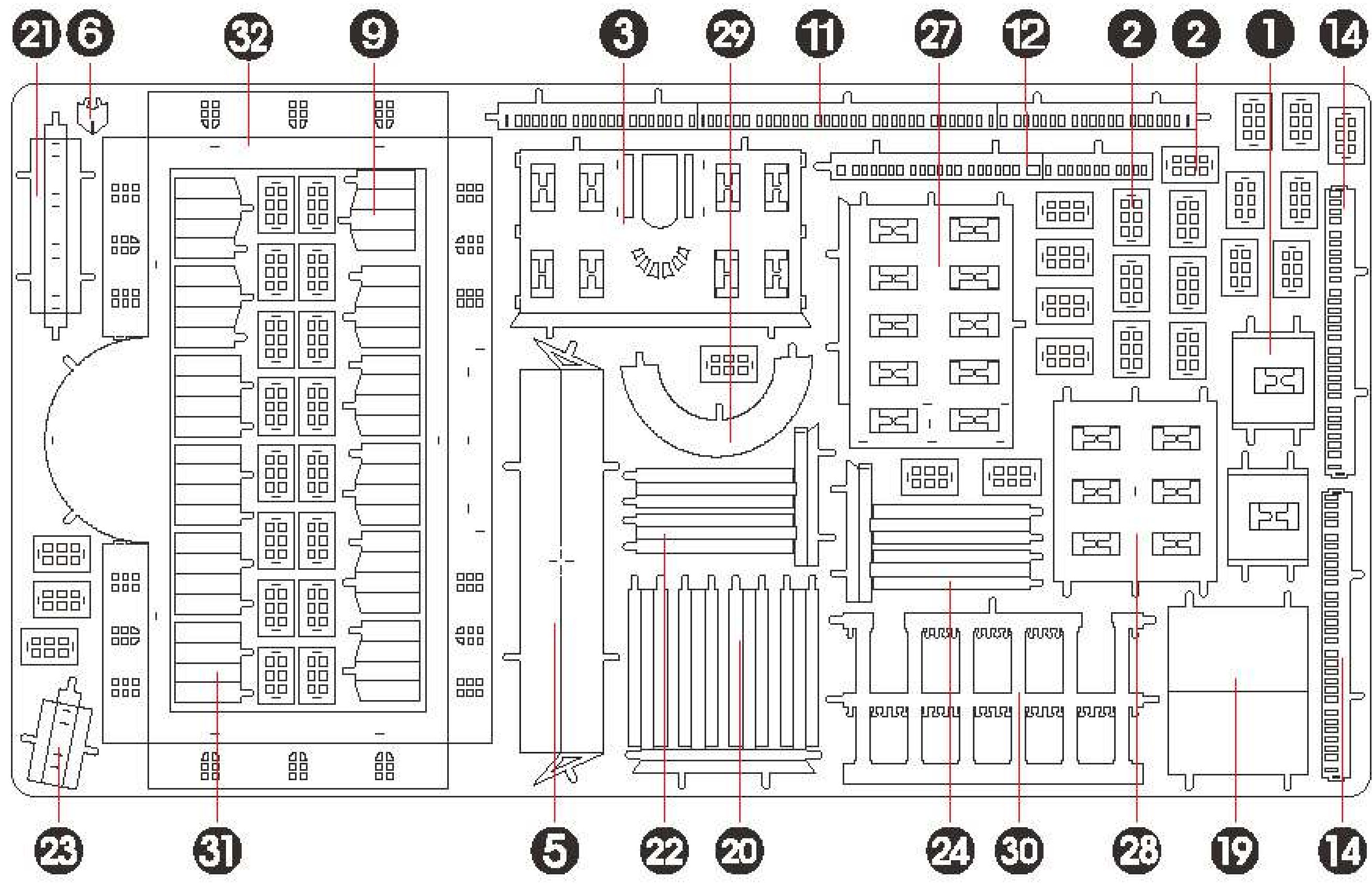

⚠ 请小心处理金属边料，以防划伤

拼装步骤

Step 1

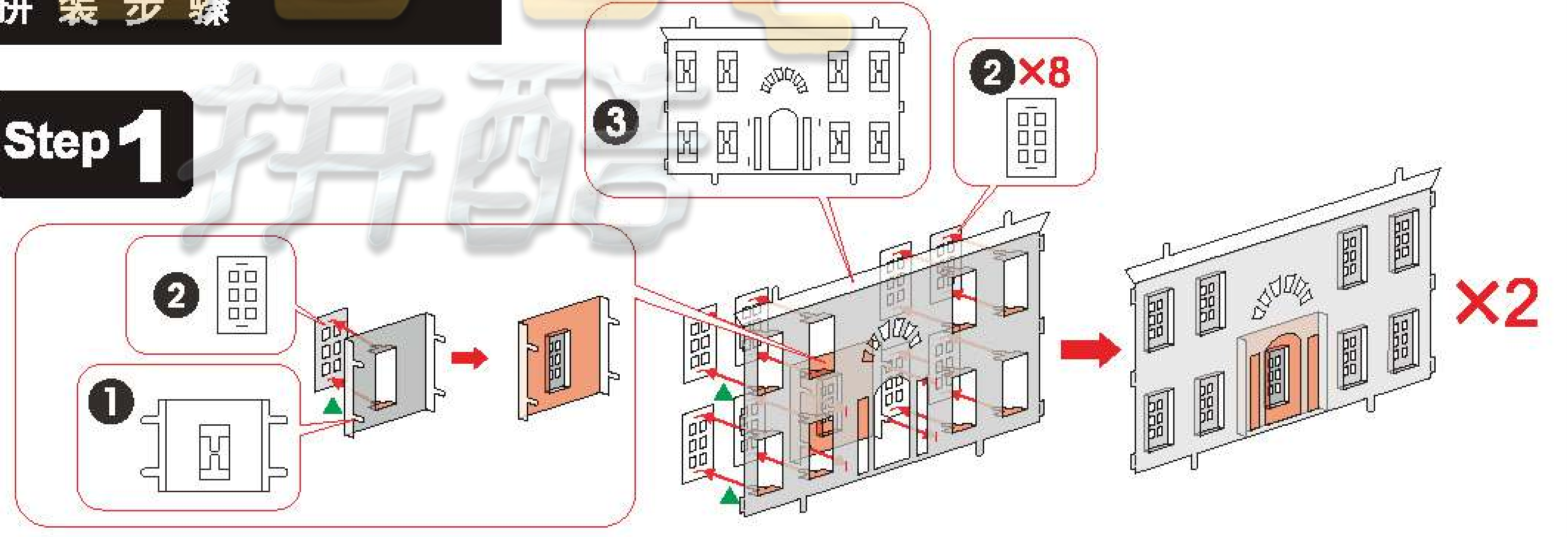

Step 2

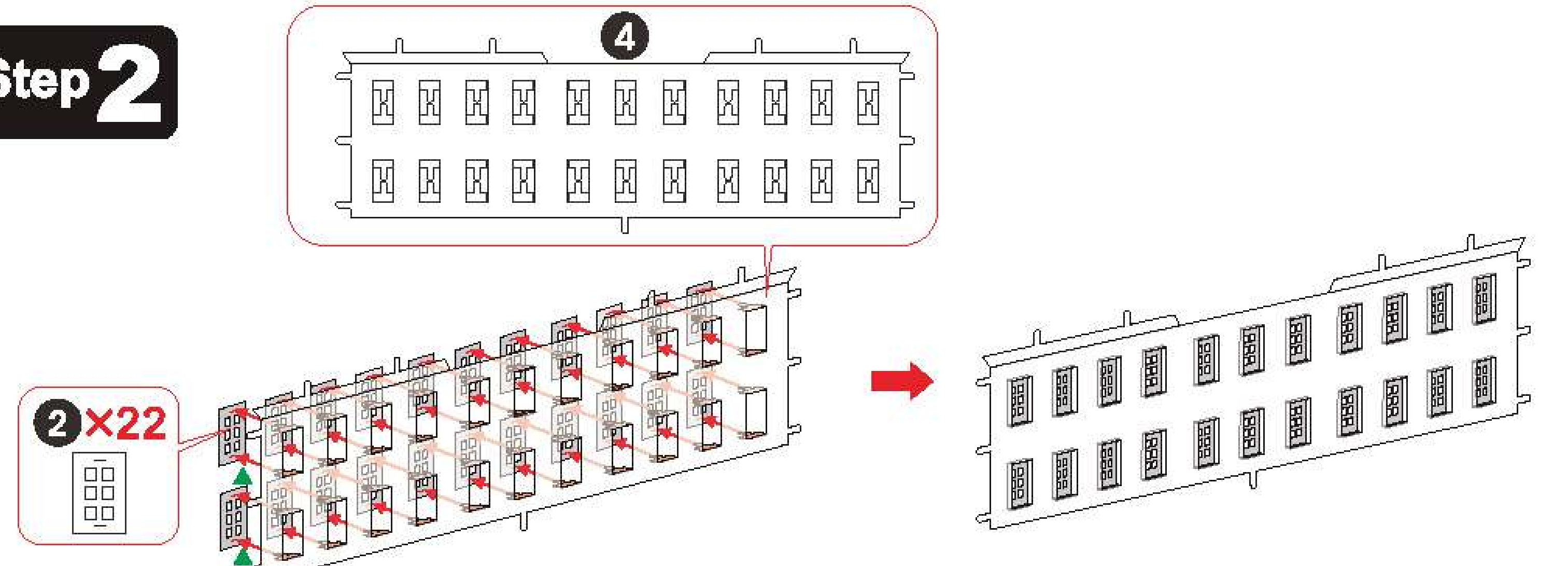

Step 3

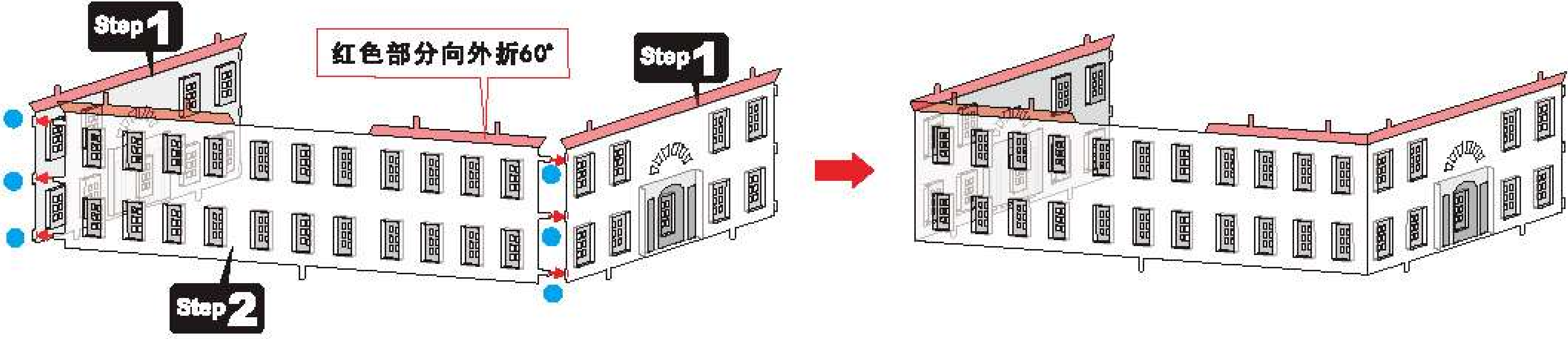

Step 4

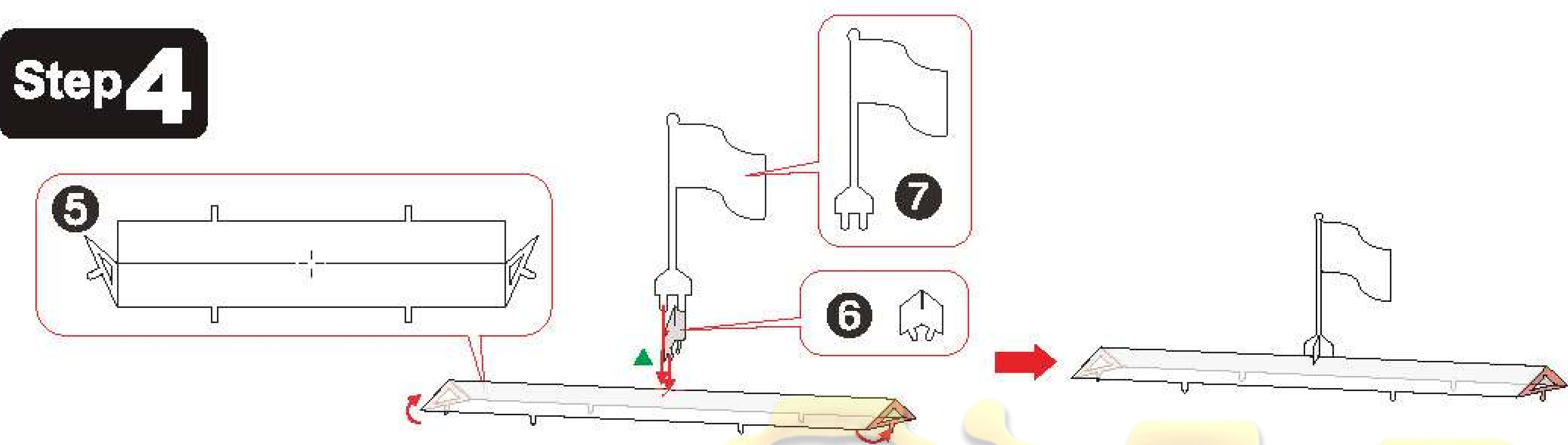

Step 5

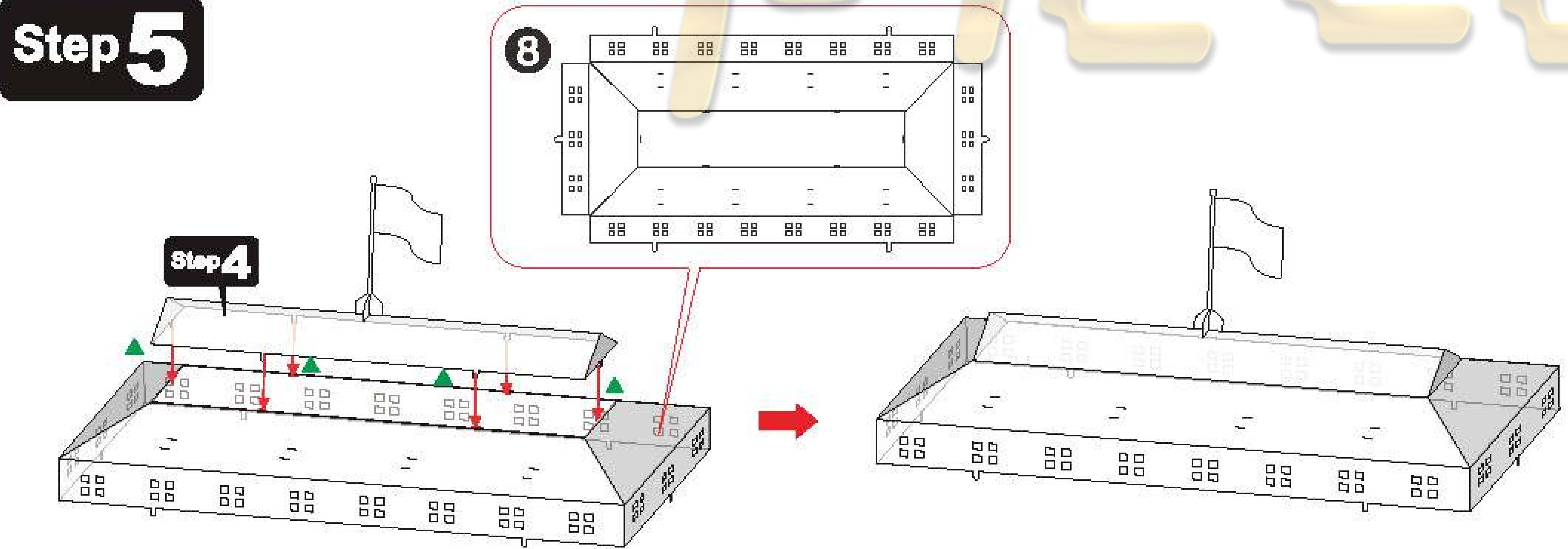

Step 6

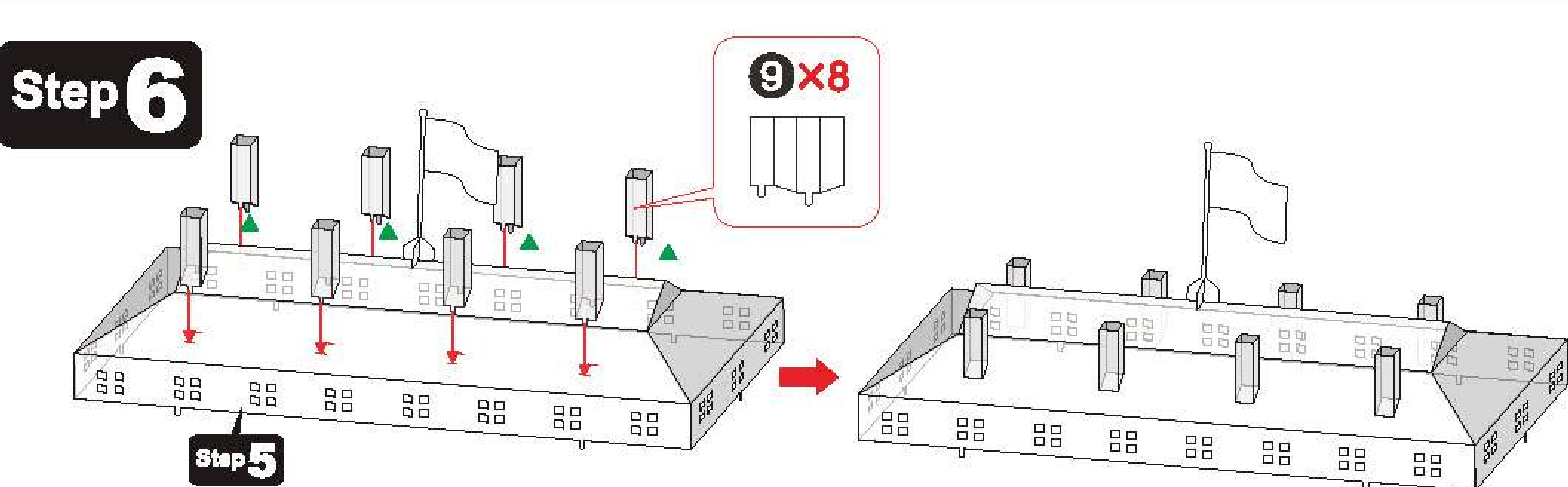

Step 7

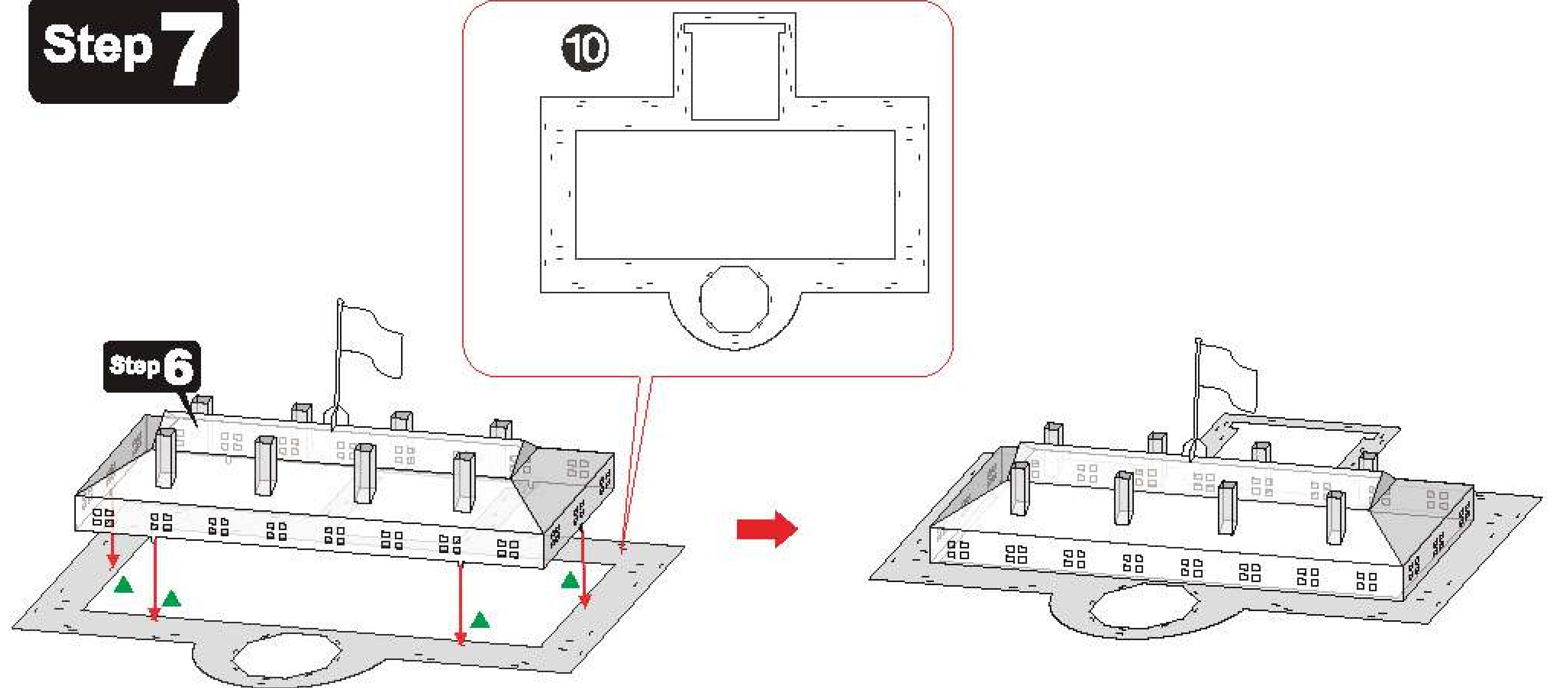

Step 8

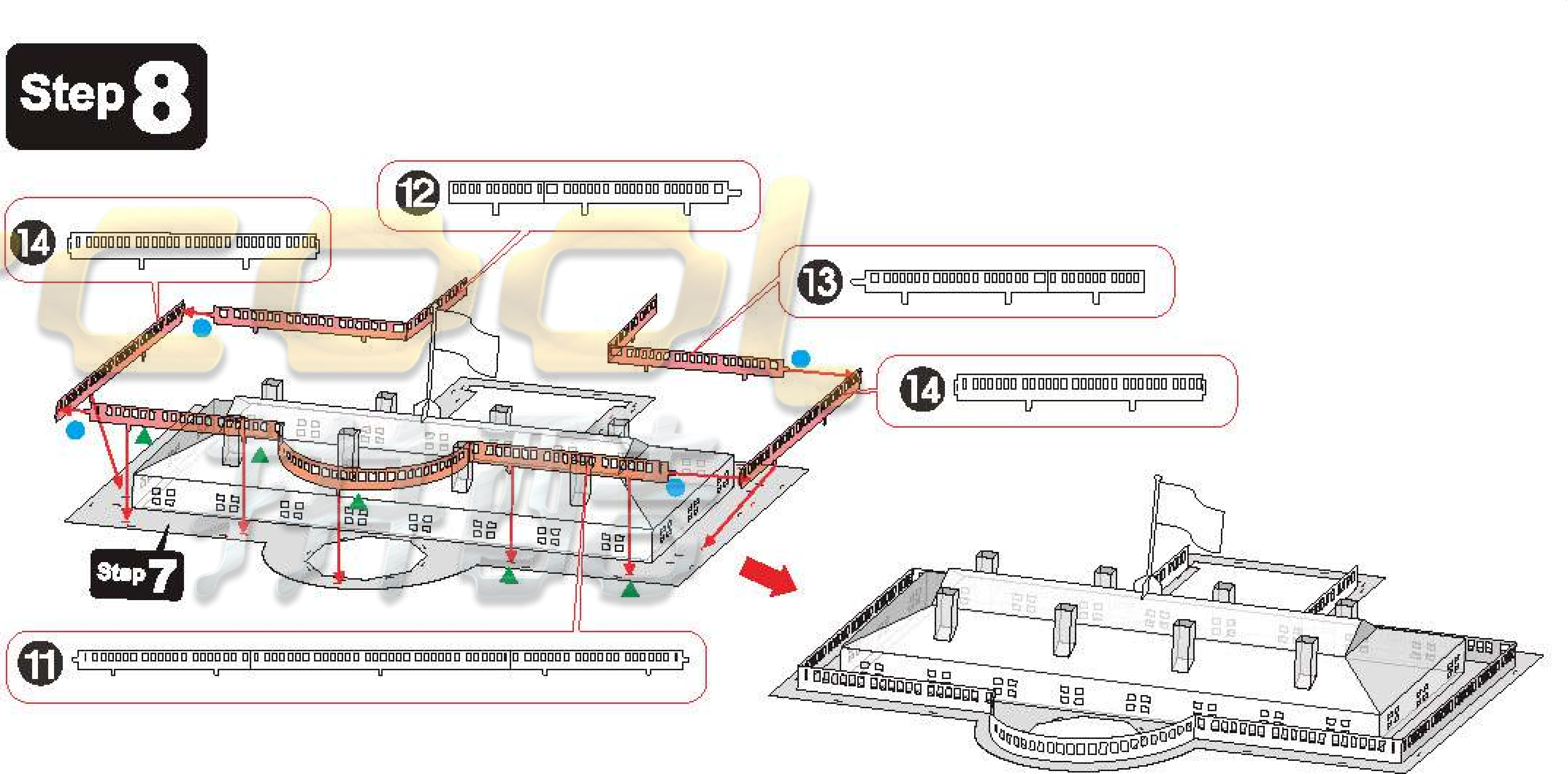

Step 9

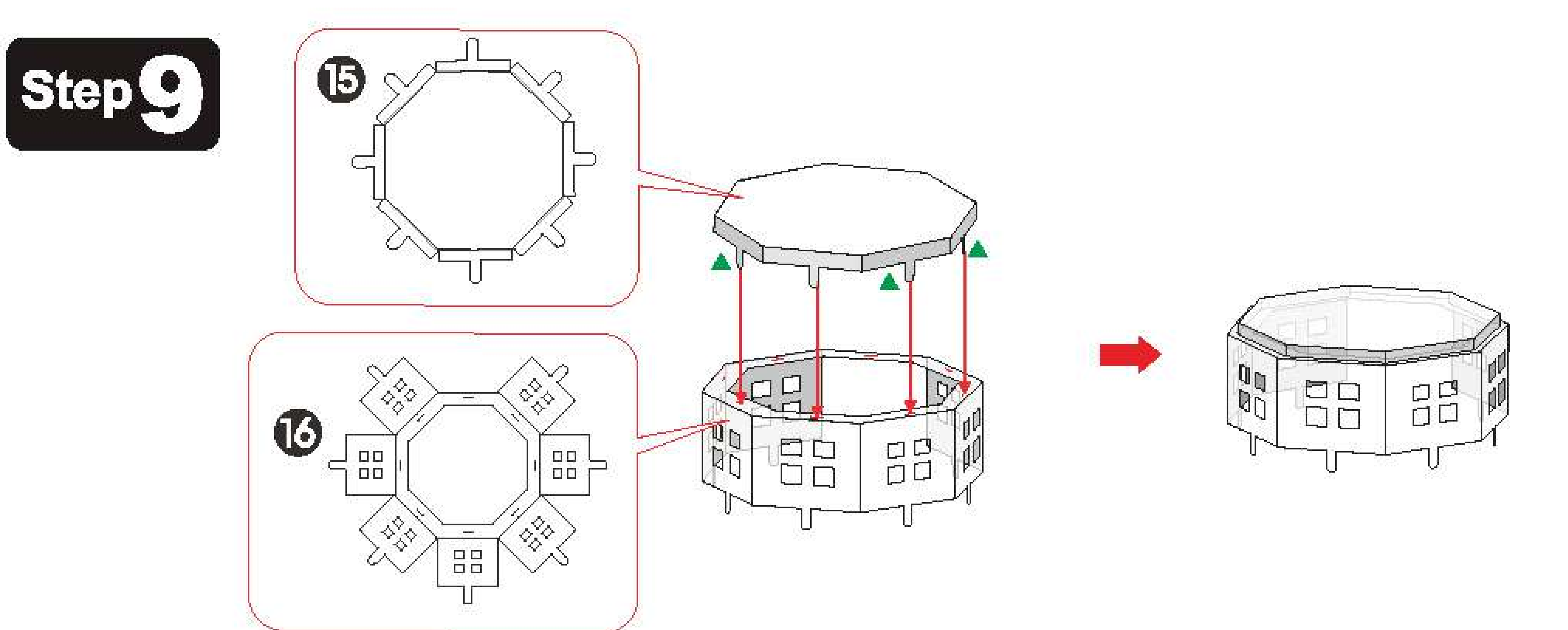

Step 10

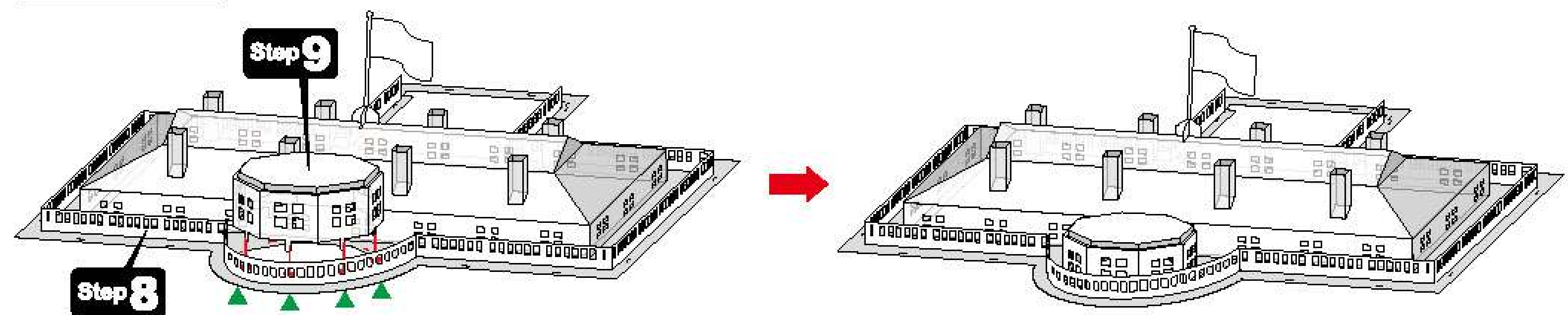

Step 11

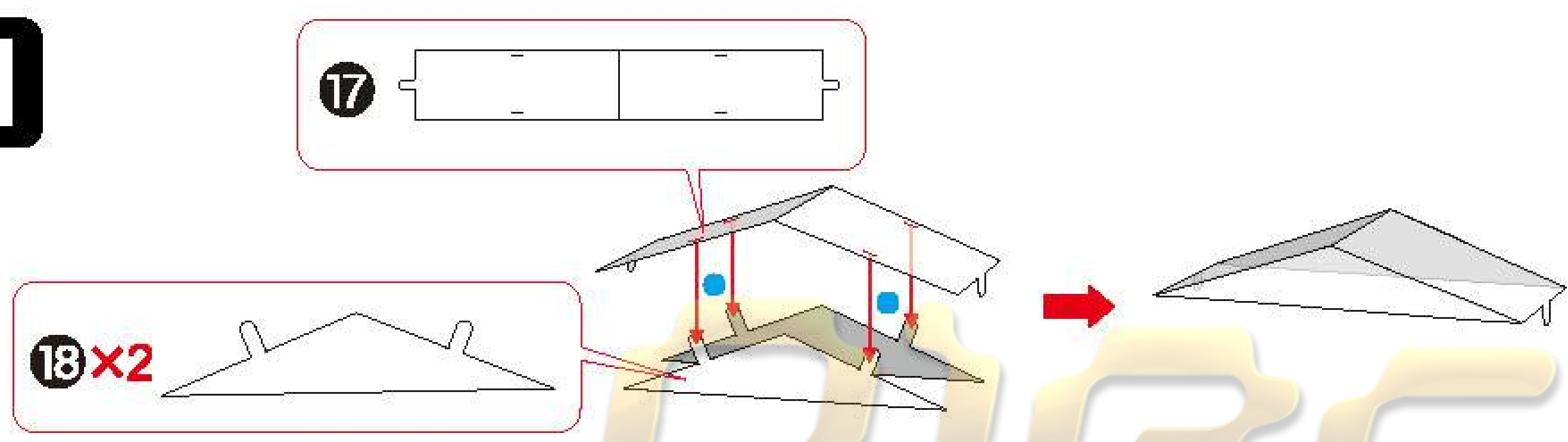

Step 12

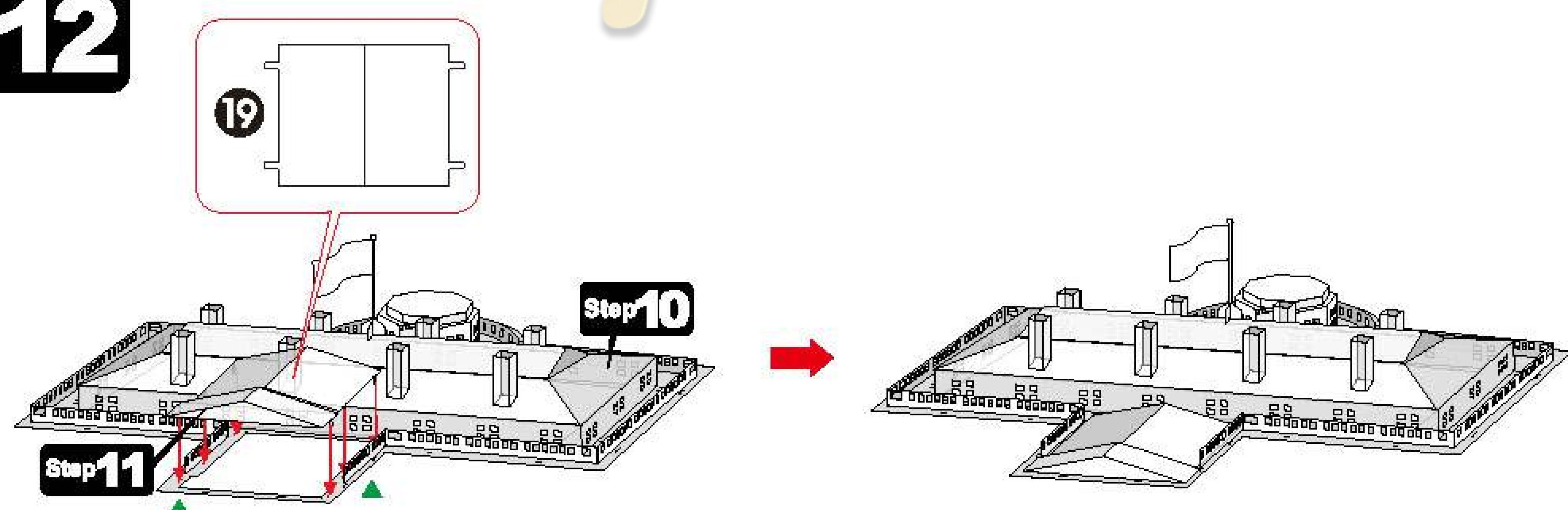

Step 14

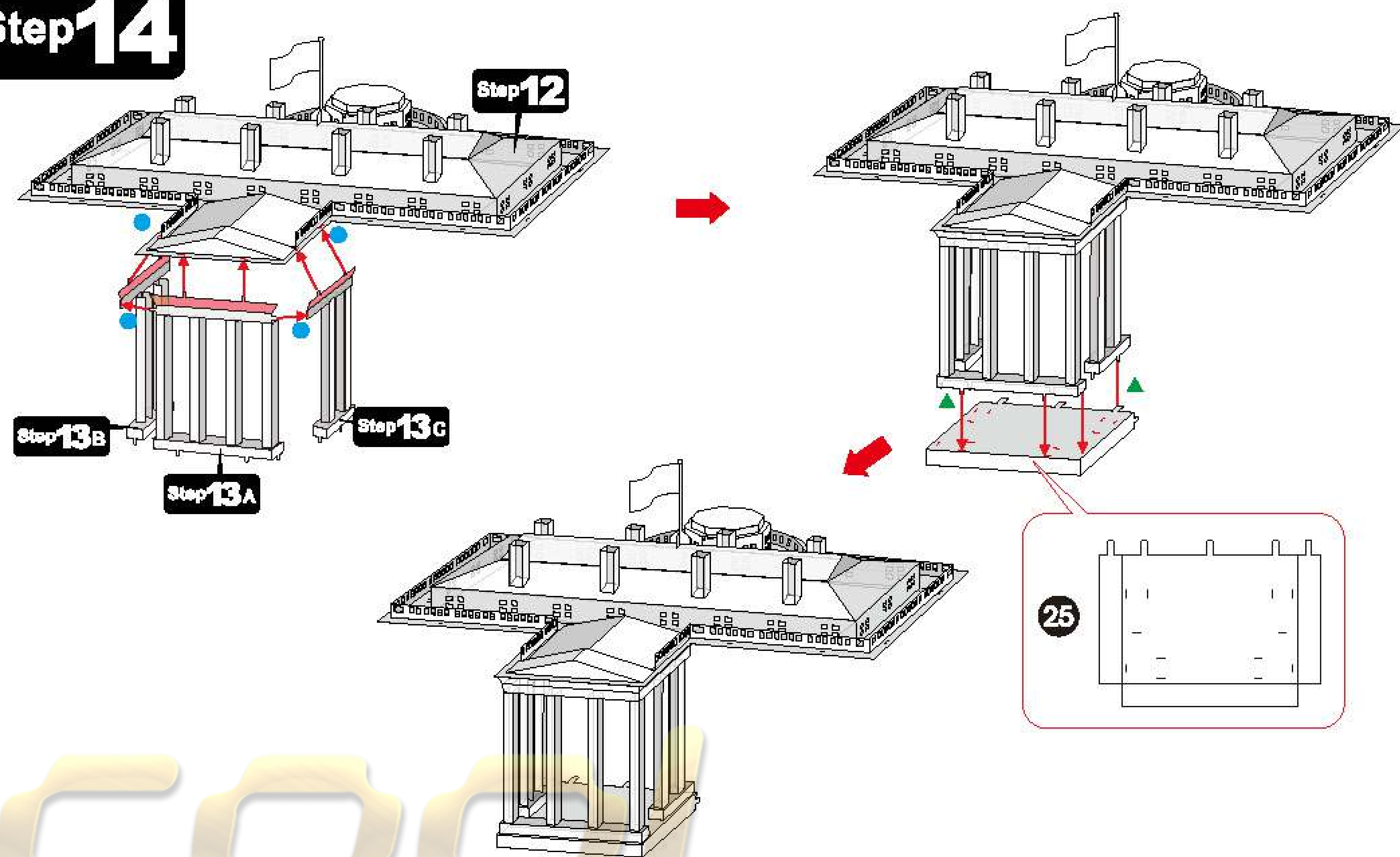

Step 15

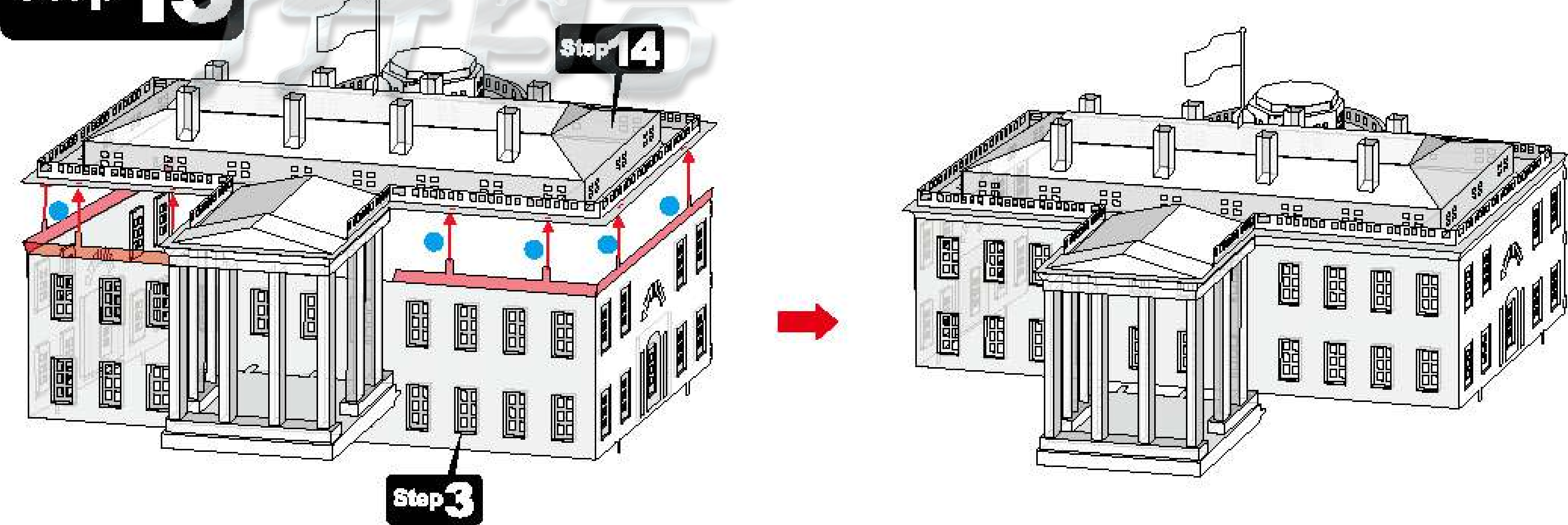

Step 13A

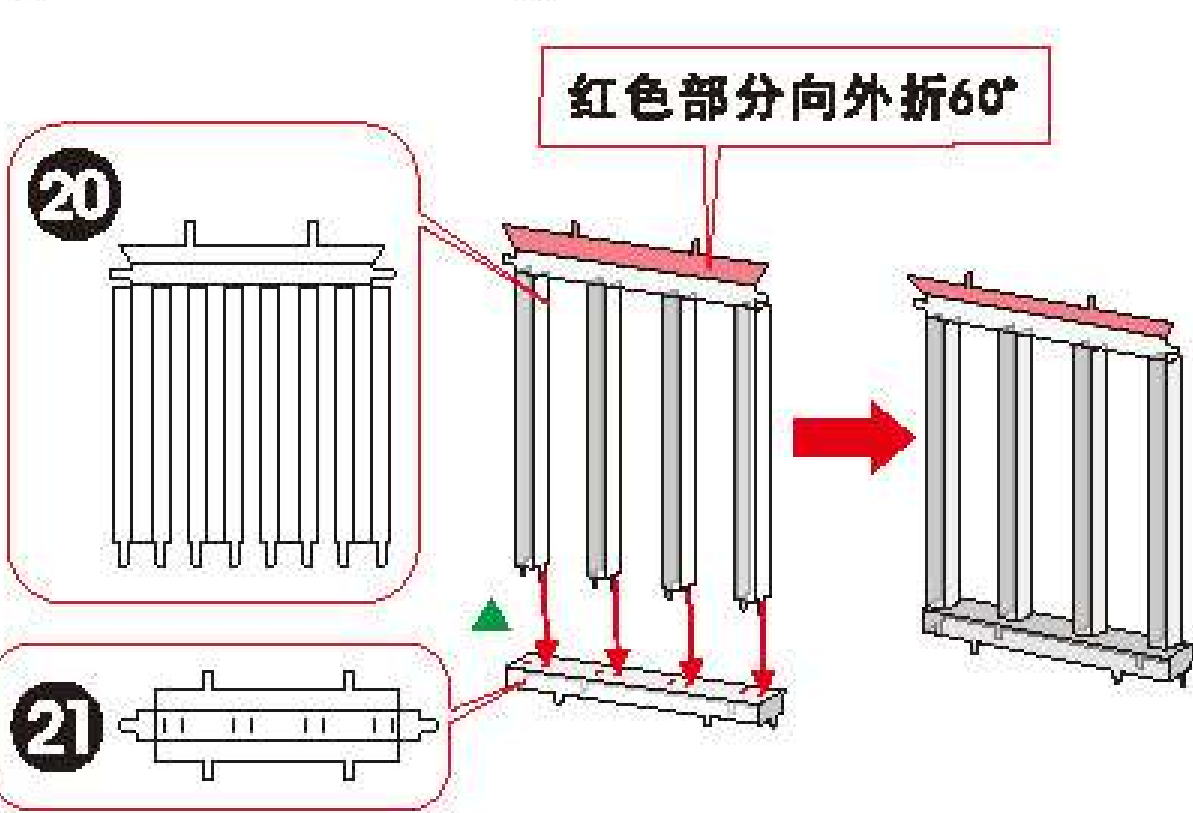

Step 13B

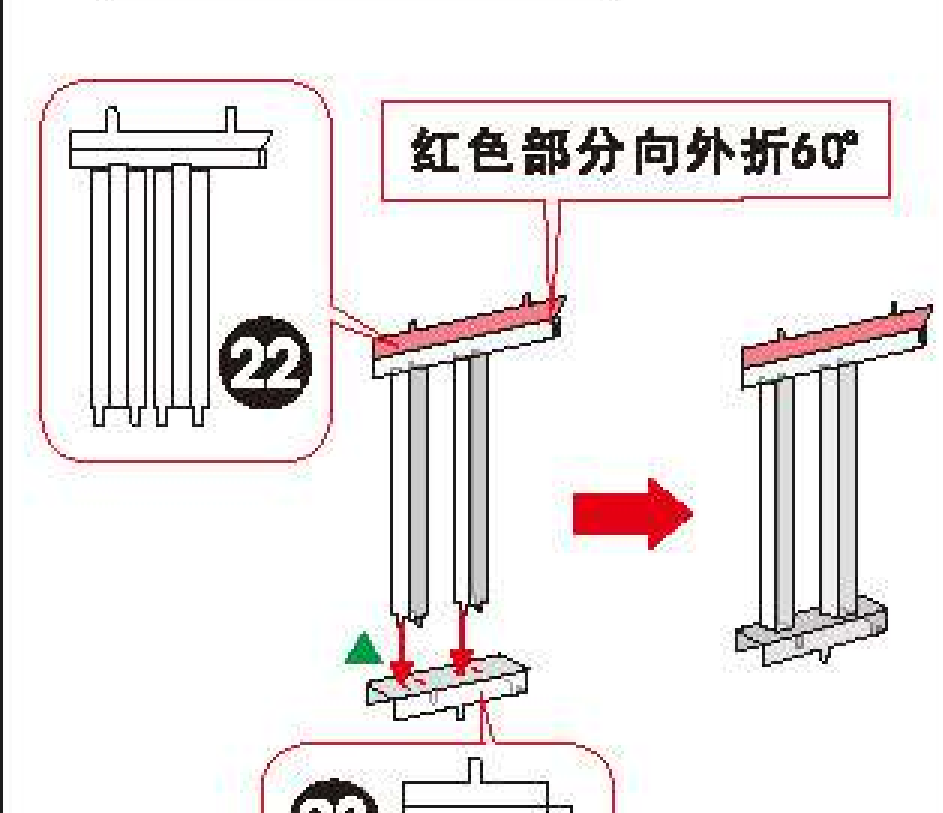

Step 13C

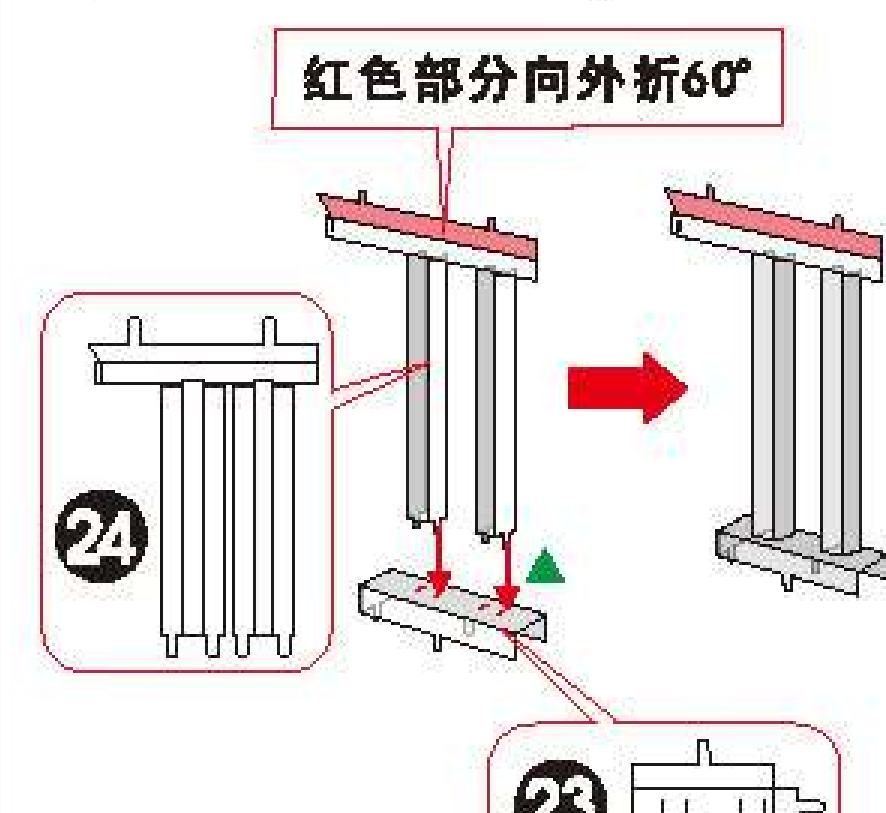

Step 16A

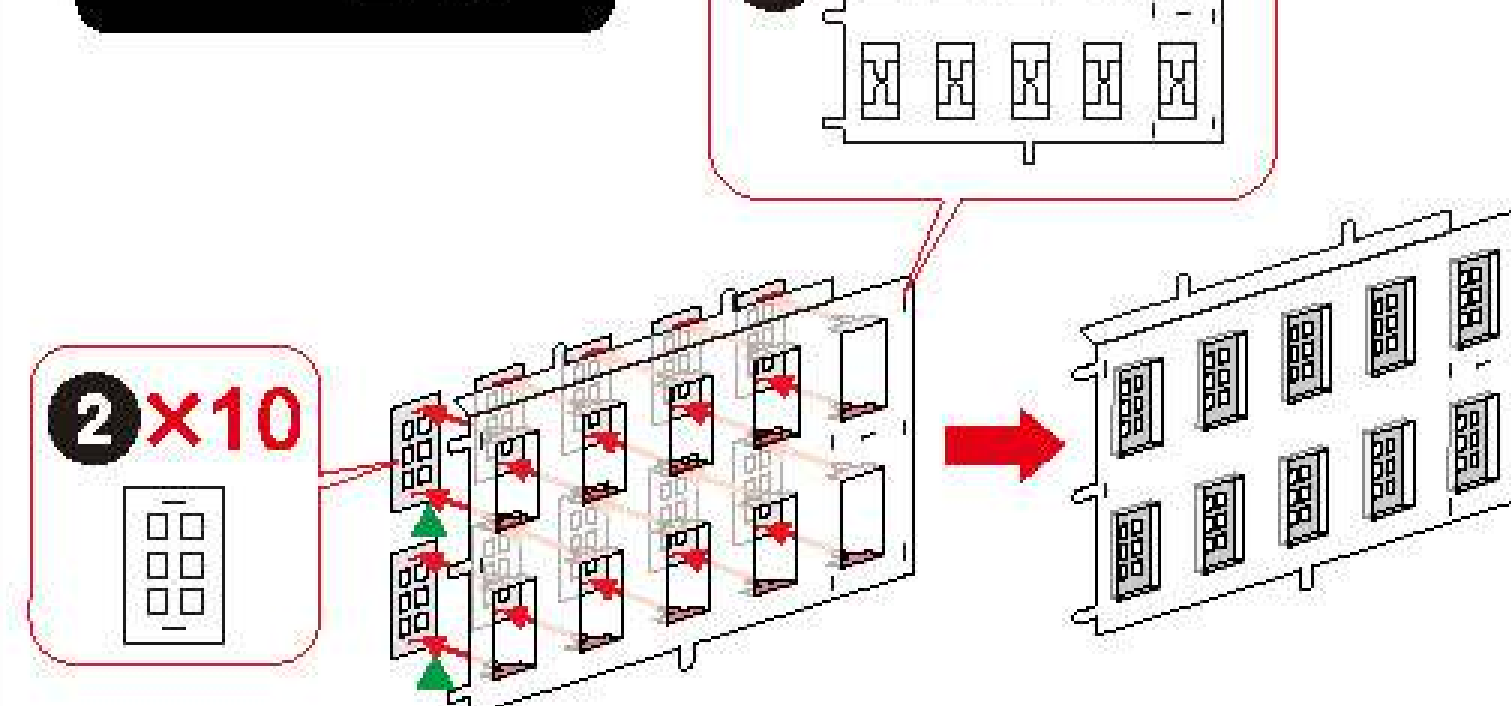

Step 16B

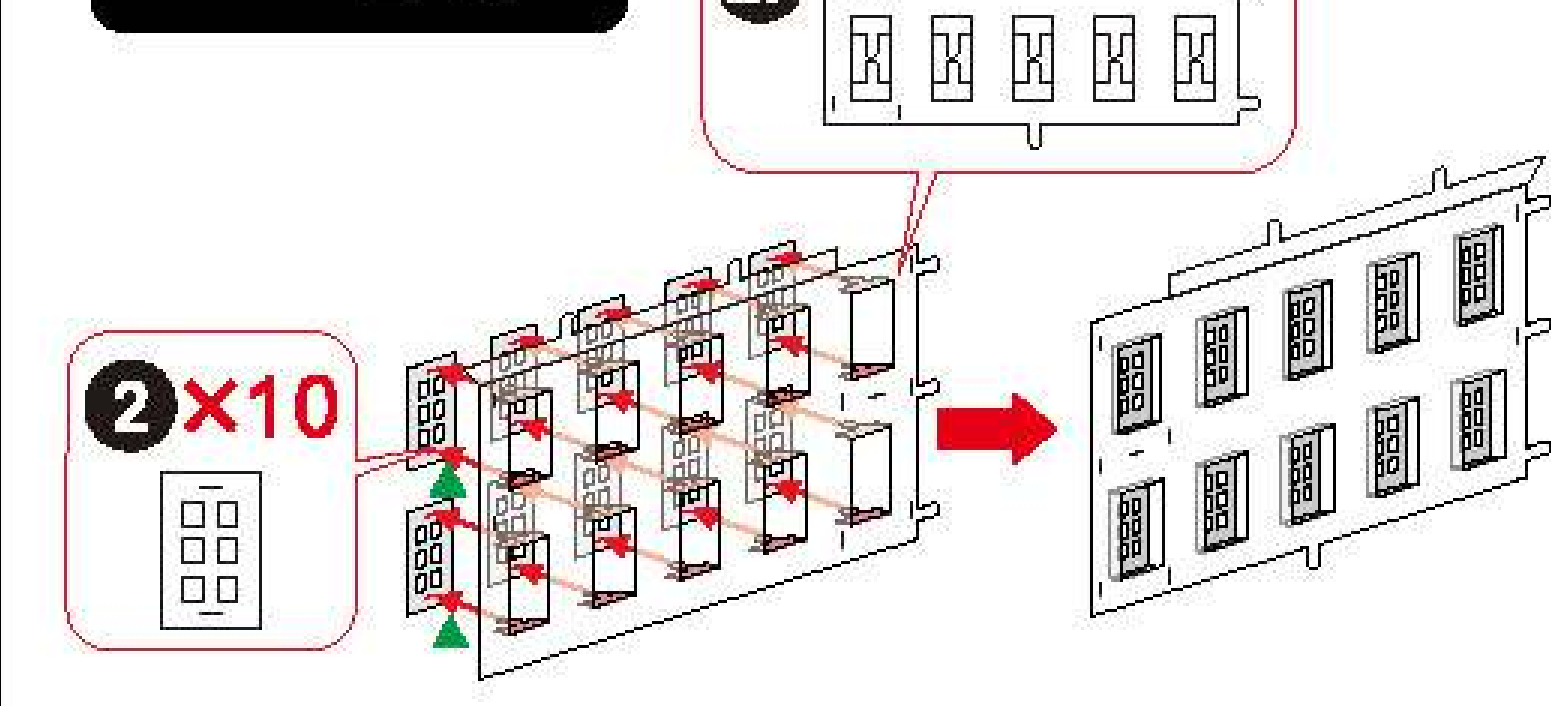

Step 17

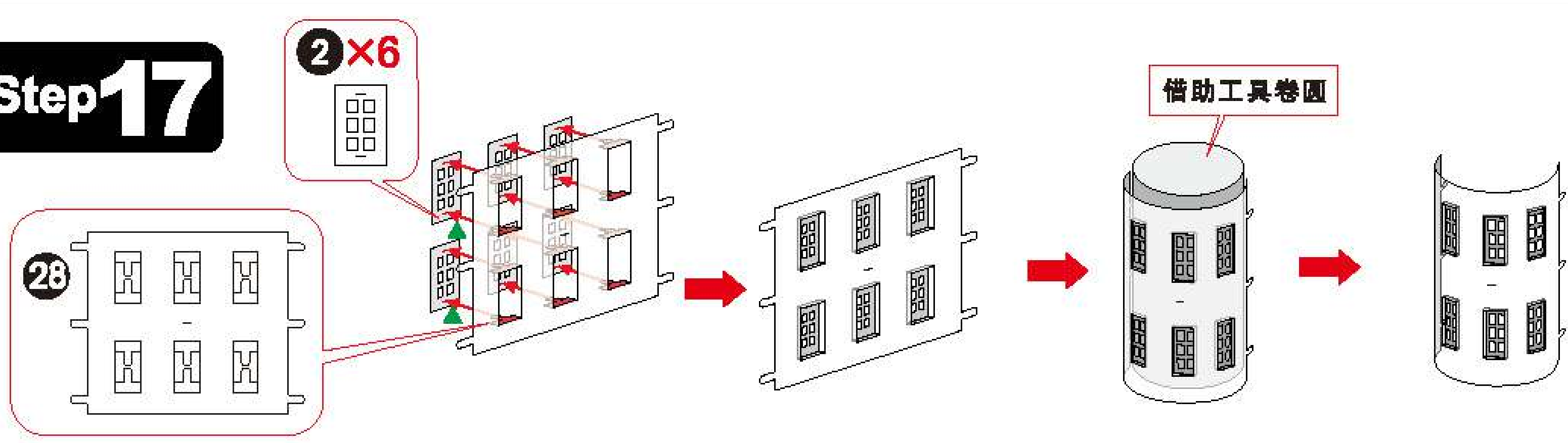

Step 18

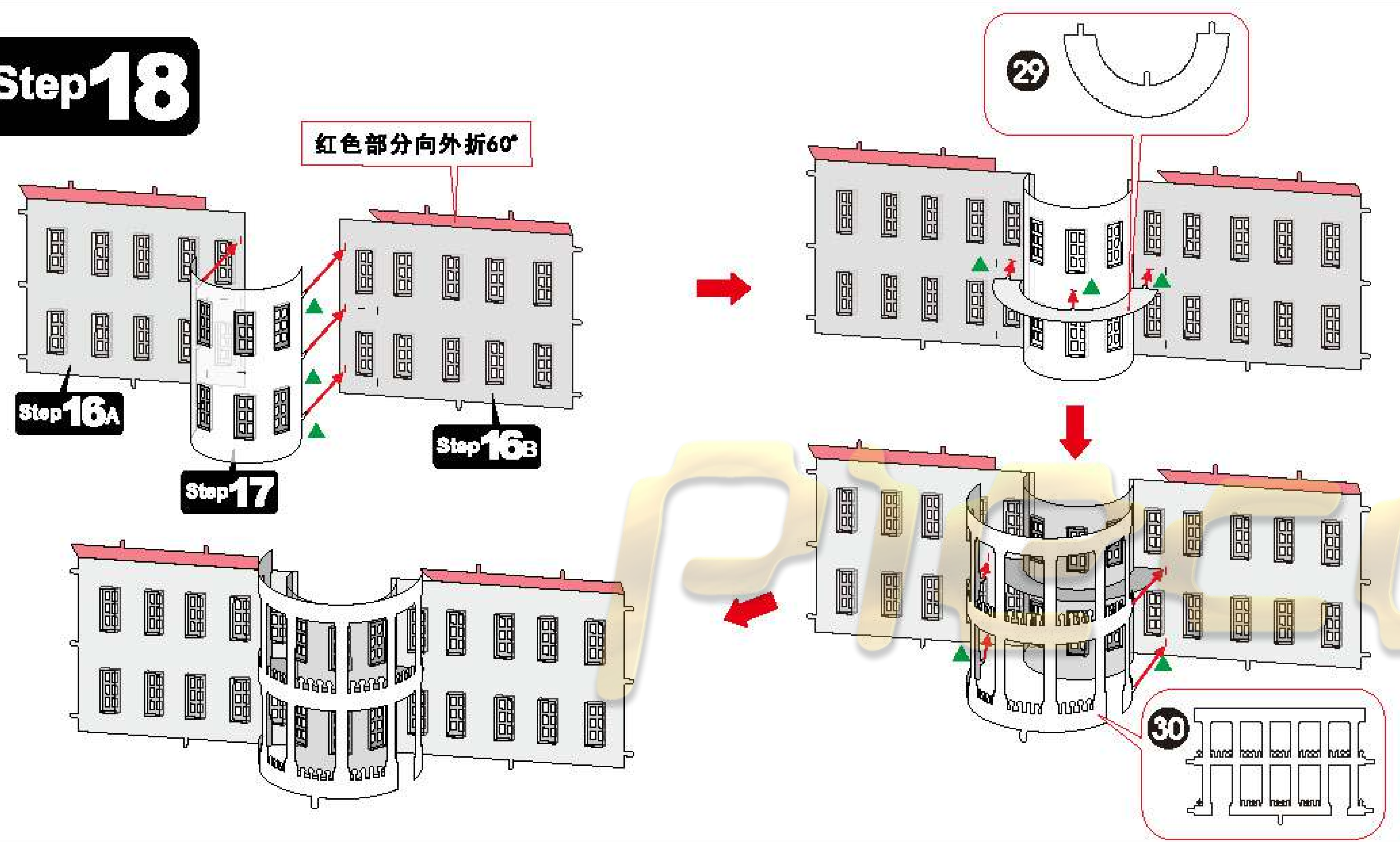

Step 19

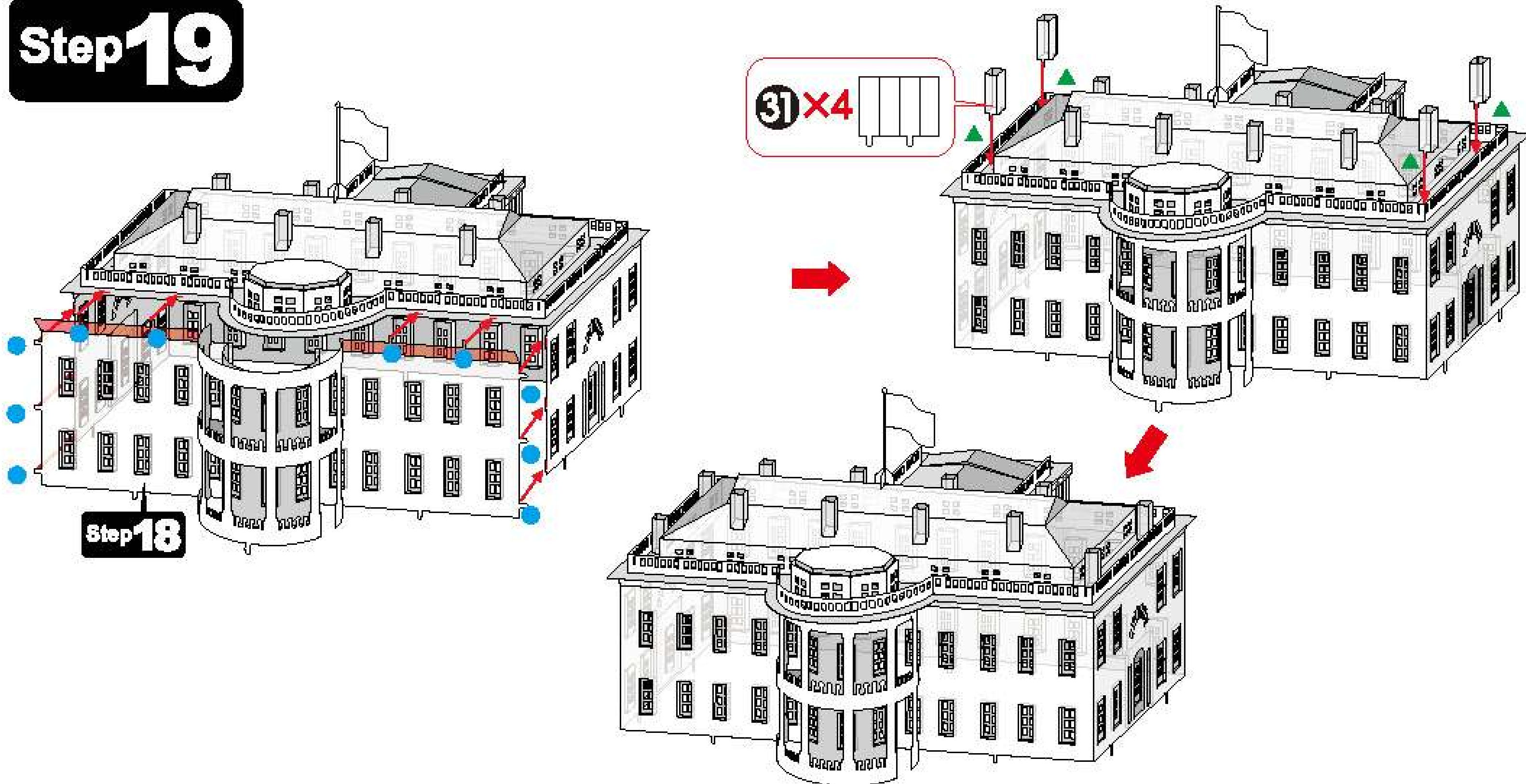

Step 20

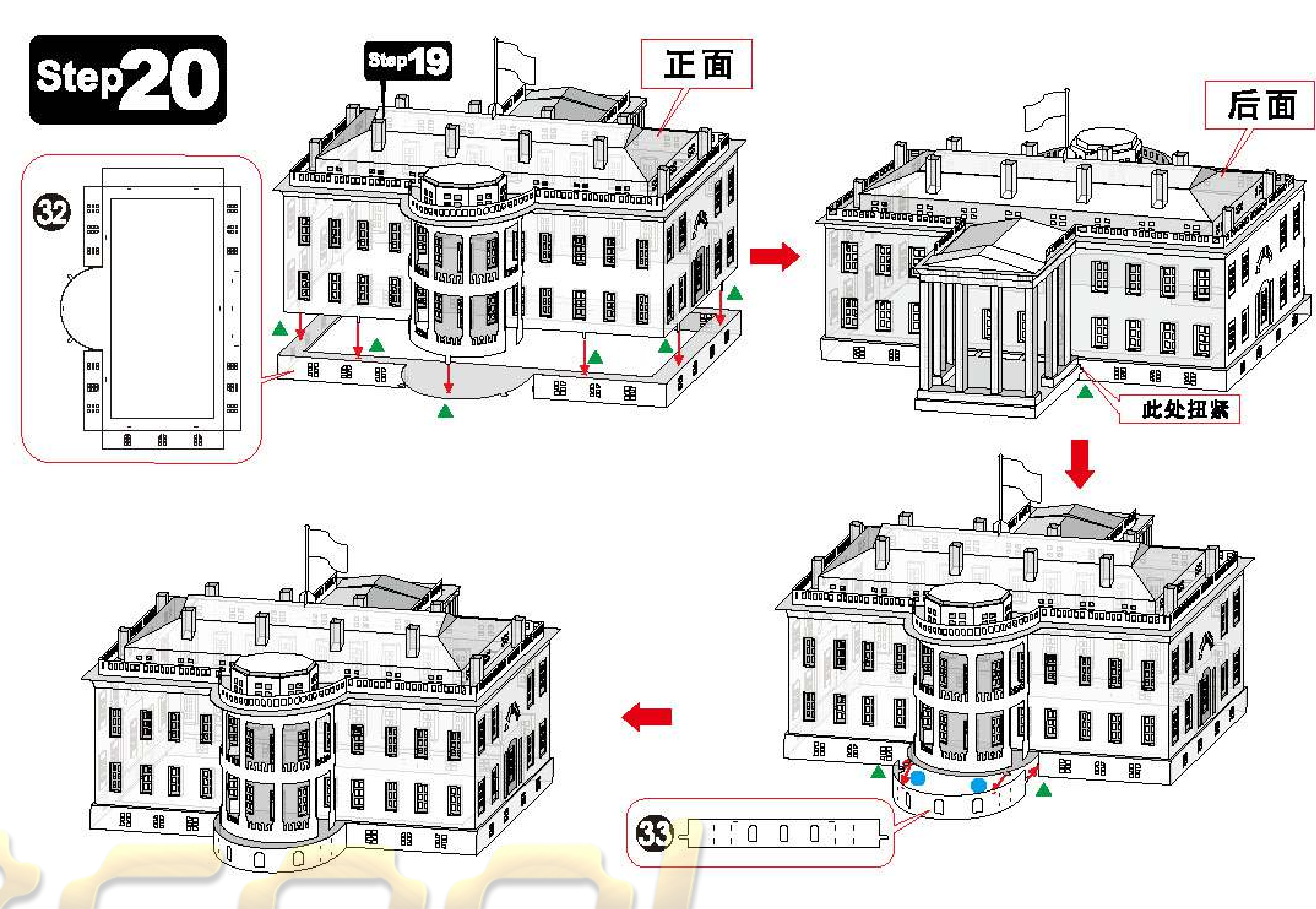

Step 21A

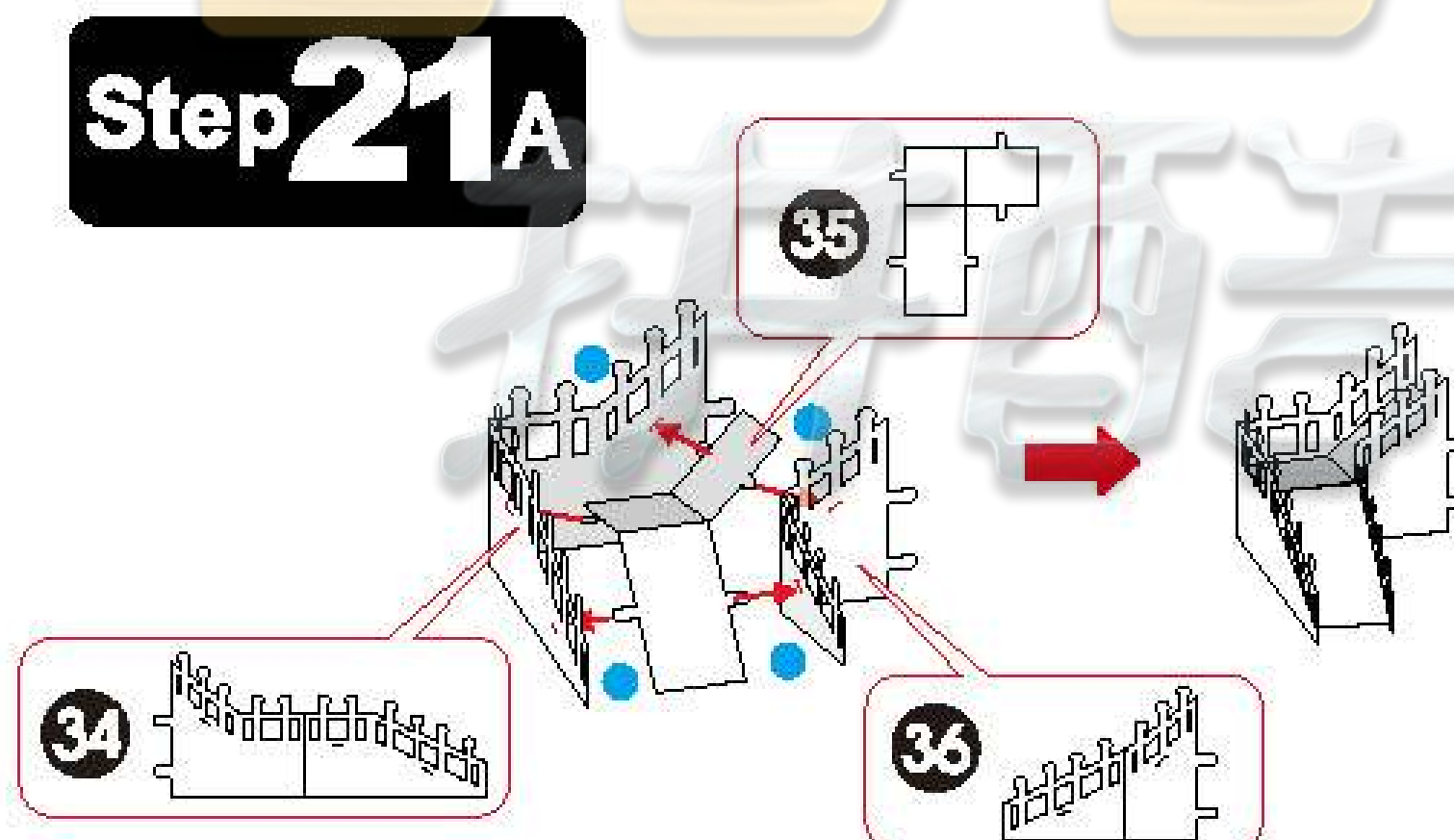

Step 21B

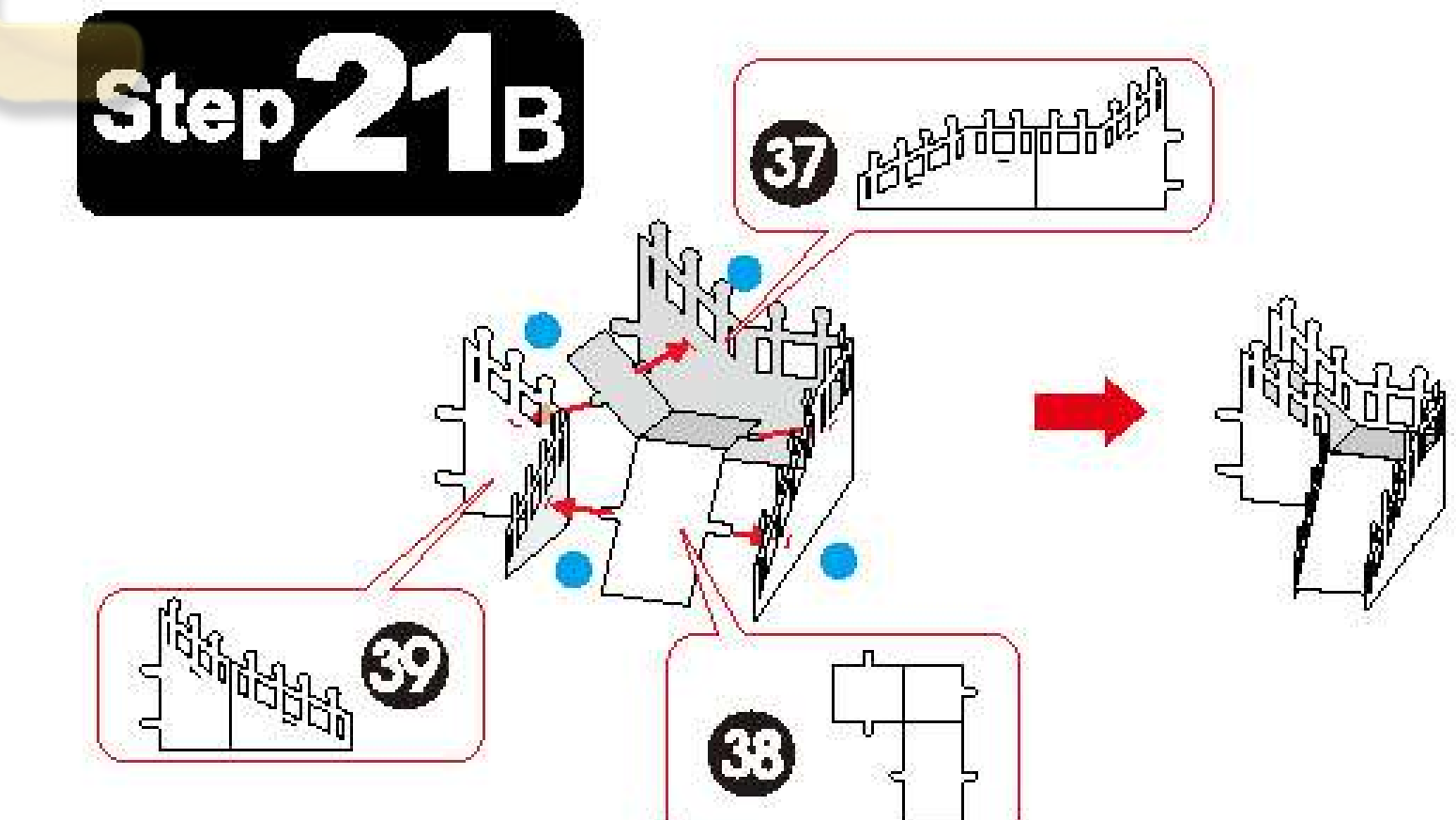

Step 22

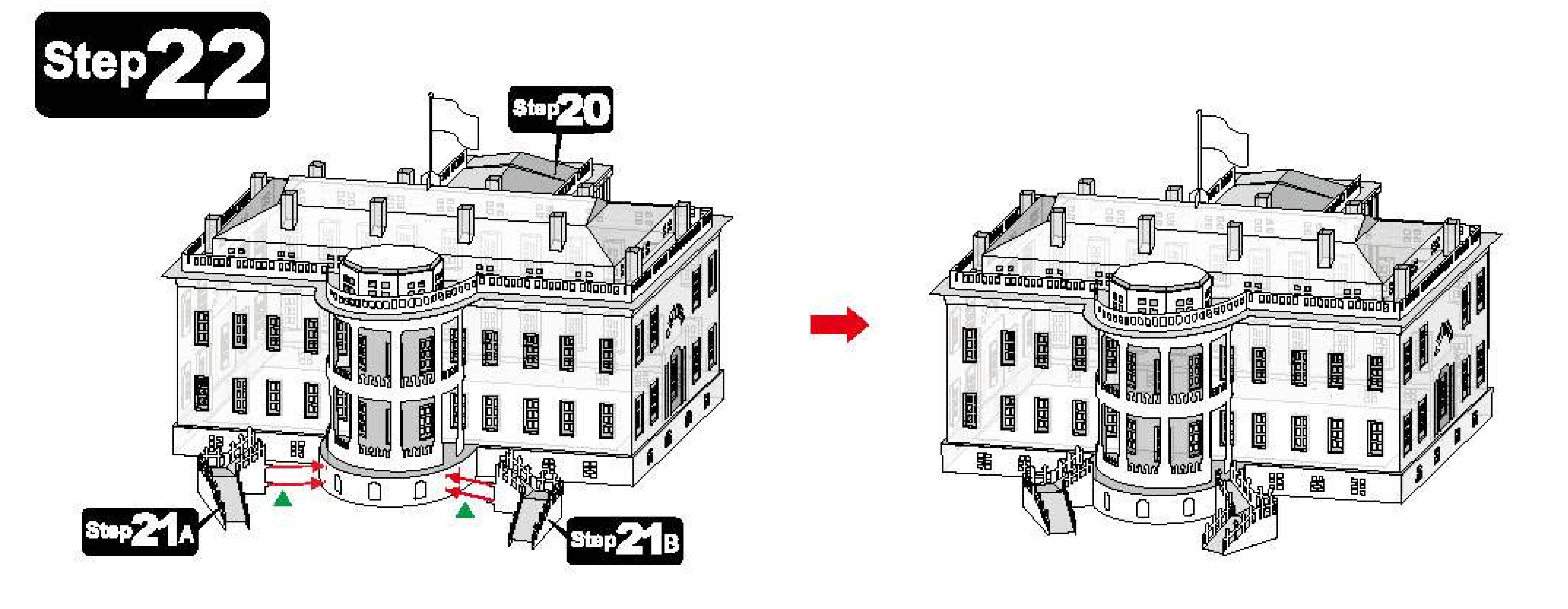

Piececool
拼酷

www.Piececool.com

© WIST PLASTIC & METAL TECHNOLOGY LIMITED. ALL RIGHTS RESERVED.