

# Piececool 拼酷

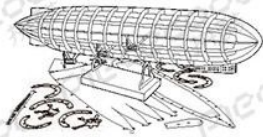

PC017

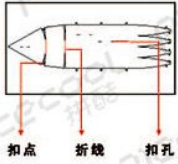

## 拼装方式

● 插入扣孔，平折 90°

▲ 插入扣孔，旋转 90°

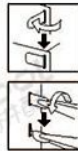

## 金属部件

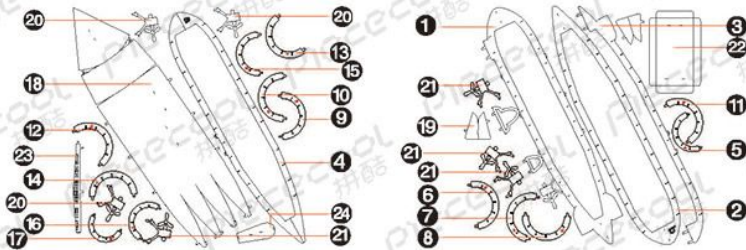

⚠ 请小心处理金属边料，以防划伤

## 拼装步骤

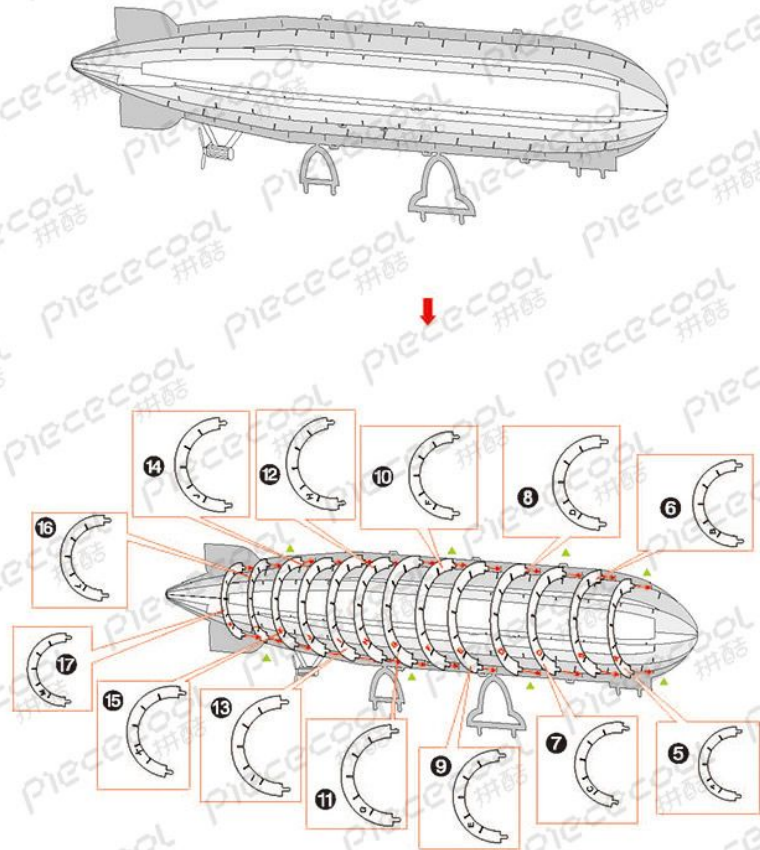
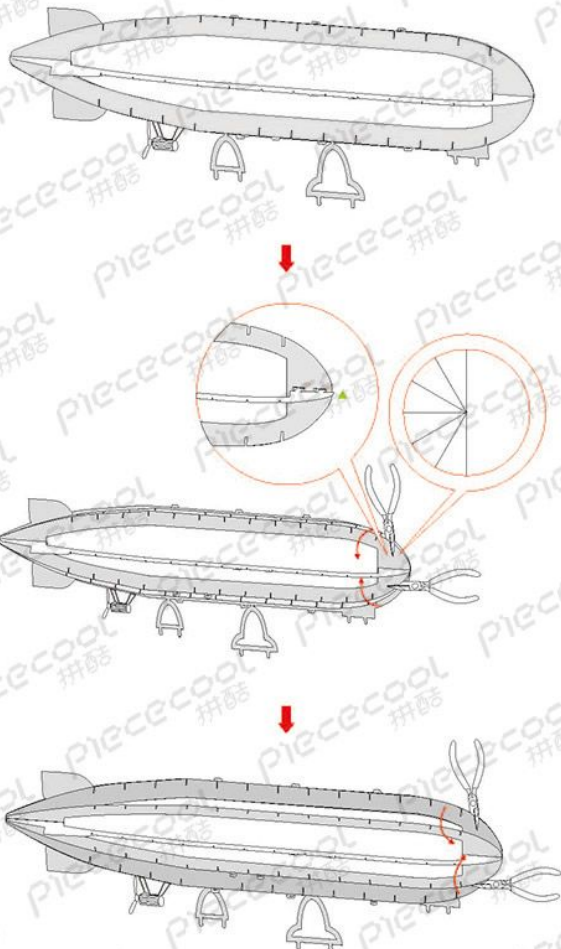
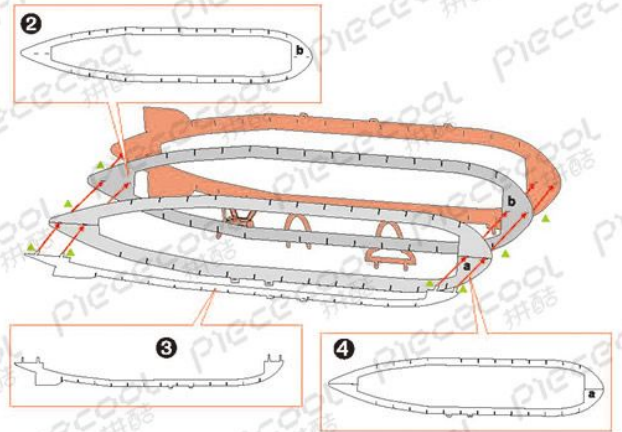
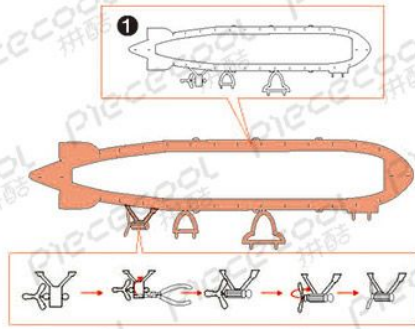



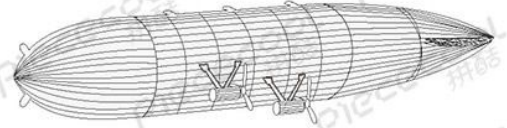
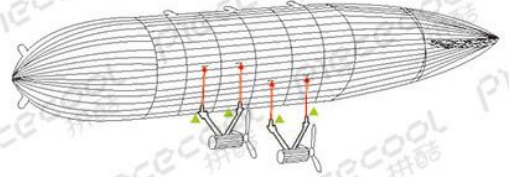
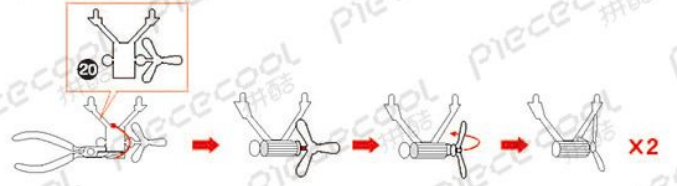
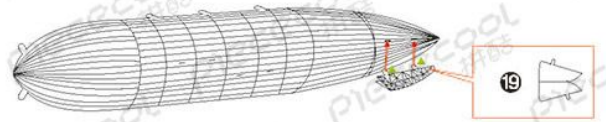
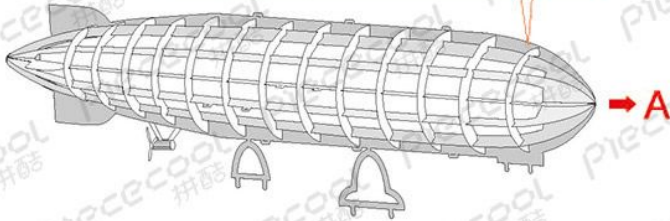
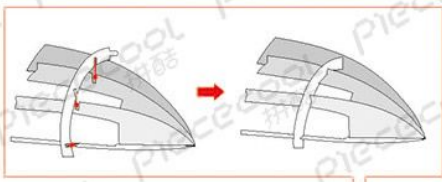

B

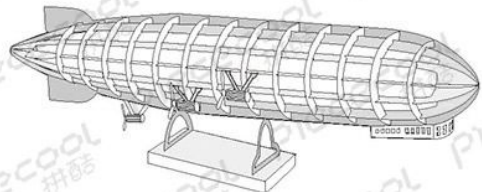
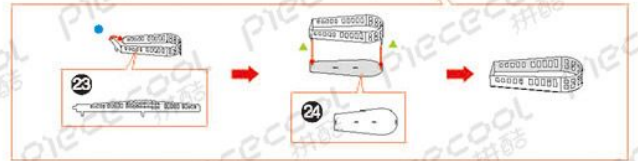
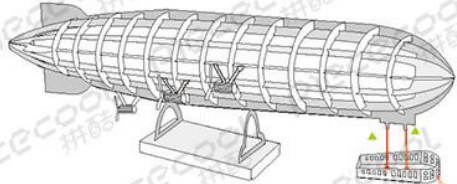
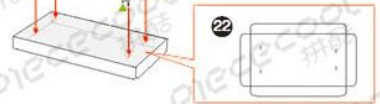
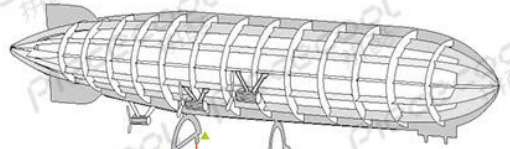

撥動工具卷圓

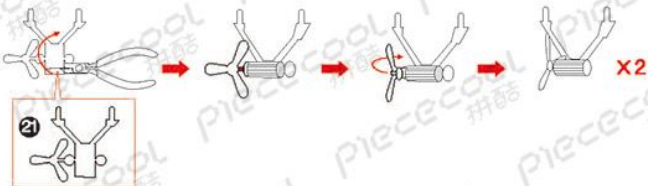
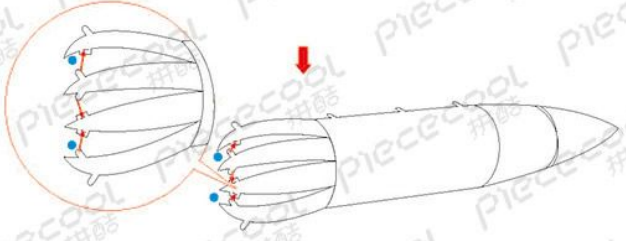
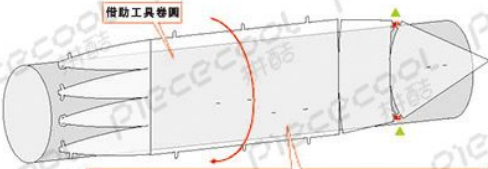

A

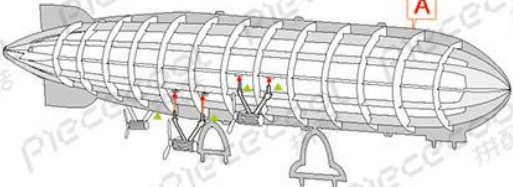

B

